

Notice

Hewlett-Packard to Agilent Technologies Transition

This documentation supports a product that previously shipped under the Hewlett-Packard company brand name. The brand name has now been changed to Agilent Technologies. The two products are functionally identical, only our name has changed. The document still includes references to Hewlett-Packard products, some of which have been transitioned to Agilent Technologies.



Agilent Technologies

Programmer's Guide

HP 8719D/20D/22D Network Analyzer



**HP Part No. 08720-90293 Supersedes October
Printed in USA February 1999**

Notice.

The information contained in this document is subject to change without notice.

Hewlett-Packard makes no warranty of any kind with regard to this material, including but not limited to, the implied warranties of merchantability and fitness for a particular purpose. Hewlett-Packard shall not be liable for errors contained herein or for incidental or consequential damages in connection with the furnishing, performance, or use of this material.

Assistance

Product *maintenance agreements* and other *customer assistance agreements* are **available for Hewlett-Packard** products. *For any* assistance, **contact your** nearest *Hewlett-Packard* Sales and Service Office.

Table O-1. Hewlett-Packard Sales and Service Offices

UNITED STATES		
Instrument Support Center Hewlett-Packard Company (800) 403-0801		
EUROPEAN FIELD OPERATIONS		
Headquarters Hewlett-Packard S.A. 150, Route du Nant-d'Avril 1217 Meyrin 2/Geneva Switzerland (4122) 780.8111	Prance Hewlett-Packard Prance 1 Avenue Du Canada Zone D'Activite De Courtaboeuf F-91947 Les Ulis Cedex Prance (33 1) 69 82 60 60	Germany Hewlett-Packard GmbH Hewlett-Packard Strasse 61352 Bad Homburg v.d.H Germany (49 6172) 16-0
Great Britain Hewlett-Packard Ltd. Eskdale Road, Winnersh Triangle Wokingham, Berkshire RG41 5DZ England (44 734)696622		
INTERCON FIELD OPERATIONS		
Headquarters Hewlett-Packard Company 3495 Deer Creek Road Palo Alto, California, USA 94304-1316 (416) 857-5027	Australia Hewlett-Packard Australia Ltd. 31-41 Joseph Street Blackburn, Victoria 3130 (61 3) 895-2895	Canada Hewlett-Packard (Canada) Ltd. 17500 South Service Road Trans-Canada Highway Kirkland, Quebec HJQ 2X8 Canada (514) 697-4232
China China Hewlett-Packard Company 38 Bei San Huan X1 Road Shuang Yu Shu Hai Dian District Beijing, China (86 1) 256-6888	Japan Hewlett-Packard Japan, Ltd. Q-1 Takakura-Cho, Hachioji Tokyo 192, Japan (81 426) 60-2111	Singapore Hewlett-Packard Singapore (Pte.) Ltd. 150 Beach Road #29-00 Gateway West Singapore 0718 (65) 291-9088
Taiwan Hewlett-Packard Taiwan 8th Floor, H-P Building 337 Fu Hsing North Road Taipei, Taiwan (886 2) 712-0404		

How to Use This Guide

The Example Programs Disks

The example programs shipped with this instrument were originally written for the HP 8753D Network Analyzer, but are compatible with the HP **8719D/20D/22D** Network Analyzer. In order to maintain compatibility with the HP **8719D/20D/22D**, it will be necessary to modify certain example programs. The example programs that need modification are clearly identified in Chapter 2, “HP **BASIC** Programming Examples.”

The following is included with the “Programming Examples HP **BASIC**” disk:

- HP **BASIC** example programs (compatible with Rocky Mountain Basic)
- **LIF** to **DOS** file-transformation utility, “**LIF2DOS.EXE**”

The following is included with the “Programming Examples QuickC and **QuickBASIC**” disk:

- QuickC example programs
- **QuickBASIC** example programs

Programming Documentation

This Programmer’s Guide consists of the following two chapters:

- **HP-IB Programming and Command Reference** provides a reference for operation of the network analyzer under **HP-IB** control and provides a description of all **HP-IB** mnemonics
- **HP BASIC Programming Examples** provides documentation for the factory-tested HP **BASIC** example programs (which offer solutions for several remotely-controlled analyzer processes).

The programming examples have only been documented for HP **BASIC** in Chapter 2. However, if the programming language QuickC or **QuickBASIC** is preferred, these versions of the programming examples can be used or **modified** while referring to Chapter 2, “HP **BASIC** Programming Examples” as an overall guide in determining the organization and logic of the **programs**.

Conventions

 **Front-Panel Key**

This represents a key physically located on the instrument.

 **Softkey**

This represents a “softkey,” a key whose label is determined by the instrument’s **firmware**.

Screen Text This represents text displayed on the instrument’s screen.

Network Analyzer Documentation Set

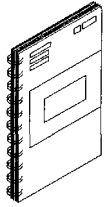

The **Installation and Quick Start Guide** familiarizes you with the network analyzer's front and rear panels, electrical and environmental operating requirements, as well as procedures for installing, configuring, and verifying the operation of the analyzer.

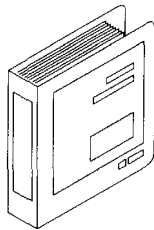

The **User's Guide** shows how to make measurements, explains commonly-used features, and tells you how to get the most performance from your analyzer.

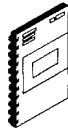

The **Quick Reference Guide** provides a summary of selected user features

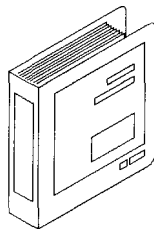

The **Programmer's Guide** provides programming information including an HP-IB programming and command reference as well as programming examples

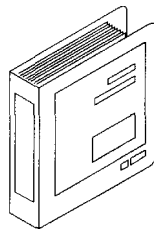

The **Service Guide** provides the information needed to adjust, troubleshoot, repair, and verify conformance to published specifications

Contents

1. HP-IB Programming and Command Reference	
Where to Look for More Information	1-2
Preset State	1-3
Analyzer Command Syntax	1-8
Code Naming Convention	1-8
Valid Characters	1-9
units	1-9
Command Formats	1-9
General Structure:	1-9
Syntax Types	1-10
HP-IB Operation	1-11
Device Types	1-11
Talker	1-11
Listener	1-11
Controller	1-11
HP-IB Bus Structure	1-12
Data Bus	1-12
Handshake Lines	1-12
Control Lines	1-12
HP-IB Requirements	1-13
HP-IB Operational Capabilities	1-14
HP-IB Status Indicators	1-15
Bus Device Modes	1-15
System-Controller Mode	1-16
Talker/Listener Mode	1-16
Pass-Control Mode	1-16
Analyzer Bus Modes	1-16
Setting HP-IB Addresses	1-17
Response to HP-IB Meta-Messages (IEEE-488 Universal Commands)	1-17
Abort	1-17
Device Clear.	1-17
Local.	1-17
Local Lockout	1-18
Parallel Poll	1-18
Pass Control	1-18
Remote	1-18
Serial Poll	1-18
Trigger	1-18
Analyzer Operation	1-19
Operation Complete	1-19
Reading Analyzer Data	1-20
Output Queue	1-20
Command Query	1-20
Identification	1-20
Output syntax.	1-20
Marker data	1-21

Array-Data Formats	1-23
Trace-Data Transfers	1-24
Stimulus-Related Values	1-25
Data-Processing Chain	1-26
Data Arrays	1-26
Fast Data Transfer Commands	1-28
Data Levels	1-28
Learn String and Calibration-Kit String	1-29
Error Reporting	1-30
Status Reporting	1-30
The Status Byte	1-32
The Event-Status Register and Event-Status Register B	1-32
Error Output	1-34
Calibration	1-34
Disk File Names	1-37
Using Key Codes.	1-38
Key Select Codes for the Network Analyzer	1-39
HP-IB Only Commands	1-62
Alphabetical Mnemonic Listing	1-69

2. **HP BASIC Programming Examples**

Introduction	2-1
Required Equipment	2-2
Optional Equipment	2-2
System Setup and HP-IB Verification	2-2
HP 8719D/20D/22D Network Analyzer Instrument Control Using BASIC	2-5
Command Structure in BASIC	2-5
Command Query	2-6
Running the Program	2-7
Operation Complete	2-8
Running the Program	2-8
Preparing for Remote (HP-IB) Control	2-8
I/O Paths	2-10
Measurement Process	2-11
Step 1. Setting Up the Instrument	2-11
Step 2. Calibrating the Test Setup	2-11
Step 3. Connecting the Device under Test	2-12
Step 4. Taking the Measurement Data	2-12
Step 5. Post-Processing the Measurement Data	2-12
Step 6. Transferring the Measurement Data	2-12
BASIC Programming Examples	2-13
Program Information.	2-14
Analyzer Features Helpful in Developing Programming Routines	2-14
Analyzer-Debug Mode	2-14
User-Controllable Sweep	2-14
Example 1: Measurement Setup	2-15
Example 1A : Setting Parameters	2-15
Running the Program	2-16
Example 1B : Verifying Parameters	2-18
Running the Program	2-19
Example 2: Measurement Calibration	2-20
Calibration Kits	2-20
Example 2A : S11 1-Port Calibration	2-21
Running the Program	2-23
Example 2B : Full 2-Port Measurement Calibration	2-23

Running the Program	2-26
Example 2C: Adapter Removal Calibration	2-27
Running the Program	2-28
Example 2D: Using Raw Data to Create a Calibration (Simmcal)	2-29
Running the Program	2-34
Example 2E: Take4 — Error Correction Processed on an External PC	2-36
Overview..	2-36
Using the Take4 Mode	2-36
Programming Example	2-37
Running the Program	2-42
Example 3: Measurement Data Transfer	2-43
Trace-Data Formats and Transfers	2-43
Example 3A: Data Transfer Using Markers	244
Running the Program	2-45
Example 3B: Data Transfer Using FORM 4 (ASCII Transfer)	2-46
Running the Program	248
Example 3C: Data Transfer Using Floating-Point Numbers	2-49
Running the Program	2-50
Example 3D: Data Transfer Using Frequency-Array Information	2-51
Running the Program	2-53
Example 3E: Data Transfer Using FORM 1, Internal-Binary Format	2-54
Running the Program	2-55
Example 4: Measurement Process Synchronization	2-56
Status Reporting	2-56
Example 4A: Using the Error Queue	2-57
Running the Program	2-58
Example 4B: Generating Interrupts	2-59
Running the Program	2-61
Example 4C: Power Meter Calibration	2-62
Running the Program	2-65
Example 5: Network Analyzer System Setups	2-66
Saving and Recalling Instrument States	2-66
Example 5A: Using the Learn String	2-66
Running the Program	2-67
Example 5B: Reading Calibration Data	2-68
Running the Program	2-70
Example 5C: Saving and Restoring the Analyzer Instrument State	2-71
Running the Program	2-73
Example 6: Limit-Line Testing	2-74
Using List-Frequency Mode	2-74
Example 6A: Setting Up a List-Frequency Sweep	2-74
Running the Program	2-76
Example 6B: Selecting a Single Segment from a Table of Segments	2-77
Running the Program	2-79
Using Limit Lines to Perform PASS/FAIL Tests	2-79
Example 6C: Setting Up Limit Lines	2-80
Running the Program	2-82
Example 6D: Performing PASS/FAIL Tests While Tuning	2-83
Running the Program	2-85
Example 7: Report Generation	2-86
Example 7A1: Operation Using Talker/Listener Mode	2-86
Running the Program	2-87
Example 7A2: Controlling Peripherals Using Pass-Control Mode	2-88
Running the Program	2-90
Example 7A3: Printing with the Serial Port	2-91

Running the Program	2-92
Example 7B : Plotting to a File and Transferring File Data to a Plotter	2-93
Running the Program	2-94
Utilizing PC-Graphics Applications Using the Plot File	2-95
Example 7C : Reading ASCII Disk Files to the Instrument Controller's Disk File	2-96
Running the Program	2-99
Example 8: Mixer Measurements	2-100
Example 8A : Comparison of Two Mixers – Group Delay, Amplitude or Phase	2-100
Running the Program	2-103
Limit Line and Data Point Special Functions	2-104
Overview..	2-105
Example Display of Limit Lines	2-107
Limit Segments	2-108
Output Results.	2-109
Constants Used Throughout This Document	2-110
Output Limit Test Pass/Fail Status Per Limit Segment	2-111
Output Pass/Fail Status for All Segments	2-112
Example Program of OUTPSEGAF Using BASIC	2-112
Output Minimum and Maximum Point Per Limit Segment	2-114
Output Minimum and Maximum Point For All Segments	2-115
Example Program of OUTPSEGAM Using BASIC	2-116
Output Data Per Point	2-117
Output Data Per Range of Points	2-118
Output Limit Pass/Fail by Channel	2-119

Index

Figures

1-1. HP-IB Bus Structure	1-12
1-2. Analyzer Single Bus Concept	1-15
1-3. FORM 4 (ASCII) Data-Transfer Character String	1-21
1-4. The Data-Processing Chain	1-27
1-5. Status Reporting Structure	1-30
1-6. Key Codes.	1-38
2-1. The HP 8719D/20D/22D Network Analyzer System with Controller	2-3
2-2. Status Reporting Structure	2-56
2-3. Connections: Comparison of Two Mixers – Group Delay, Amplitude or Phase	2-100
2-4. Limit Segments Versus Limit Lines	2-107

Tables

0-1. Hewlett-Packard Sales and Service Offices	iii
1-1. Preset Conditions (1 of 5)	1-4
1-2. Code Naming Convention	1-8
1-3. OPC-compatible Commands	1-19
1-4. Units as a Function of Display Format	1-22
1-5. HP 8719D/20D/22D Network Analyzer Array-Data Formats	1-24
1-6. Status Bit Definitions	1-31
1-7. Status Bit Definitions (Continued)	1-32
1-8. Relationship between Calibrations and Classes	1-35
1-9. Error Coefficient Arrays	1-36
1-10. Disk File Names	1-37
1-11. Key Select Codes	1-40
1-12. HP-IB Only Commands	1-62
2-1. Additional BASIC 6.2 Programming Information	2-1
2-2. Additional HP-IB Information	2-1
2-3. Measurement Speed: Data Output and Error Correction to an External PC*	2-37
2-4. HP 8719D/20D/22D Network Analyzer Array-Data Formats	246
2-5. Limit Line and Data Point Special Functions Commands	2-105
2-6. Limit Segment Table for Figure 2-3	2-108
2-7. Example Output: OUTPSEGAM (min/max of all segments)	2-109
2-8. Pass/Fail/No Limit Status Constants	2-110
2-9. Min/Max Test Constants	2-110
2-10. Example Output: OUTPSEGAF (pass/fail for all segments)	2-112
2-11. Example Output: OUTPSEGM (min/max per segment)	2-114
2-12. Example Output: OUTPSEGAM (min/max for all segments)	2-115
2-13. Example Output: OUTPDATP (data per point)	2-117
2-14. Example Output: OUTPDATPR (data per range of points)	2-118

HP-IB Programming and Command Reference

This chapter is a reference for operation of the network analyzer under HP-IB control. You should already be familiar with making measurements with the analyzer. Information about the HP-IB commands is organized as follows:

- Analyzer Command Syntax
 - Code Naming Convention
 - Valid Characters
 - units
 - Command Formats
- HP-IB Operation
 - Device Types
 - HP-IB Bus Structure
 - **HP-IB** Requirements
 - HP-IB Operational Capabilities
 - Bus Device Modes
 - Setting HP-IB Addresses
 - Response to HP-IB **Meta-Messages** (IEEE-488 Universal Commands)
- Analyzer Operation-Complete Commands
- Reading Analyzer Data
 - Output Queue
 - Command Query
 - Output syntax
 - Marker Data
 - Array-Data Formats
 - Trace-Data Transfers
 - Stimulus-Related Values
- Data Processing Chain
 - Data Arrays
 - Fast Data Transfer Commands
 - Data Levels
 - Learn String and Calibration Kit String

- Error Reporting
 - Status Reporting
 - The Status Byte
 - The Event-Status Register and Event-Status Register B
 - Error Output
- Calibration
- Disk File Names
- Using Key Codes
- Key Select Codes Arranged by Front-Panel **Hardkey**
- **HP-IB** Only Commands
- Alphabetical Mnemonic Listing

For information about manual operation of the analyzer, refer to the *HP 8719D/20D/22D Network Analyzer User's Guide*.

Where to Look for More Information

Additional information covering many of the topics discussed in this chapter is located in the following:

- *Tutorial Description of the Hewlett-Packard Interface Bus*, presents a description and discussion of all aspects of the HP-IB. A thorough overview of **all** technical details as a broad tutorial HP publication, HP part number 5021-1927.
- *IEEE Standard Digital Interface for Programmable Instrumentation ANSI/IEEE std 488.1-1987* contains detailed information on **IEEE-488** operation. Published by the Institute of Electrical and Electronics Engineers, Inc, 345 East **47th** Street, New York, New York 10017.
- Chapter 2, "HP BASIC programming examples," includes programming examples in HP BASIC.

Preset State

When the **Preset** key is pressed, the analyzer reverts to a known state called the factory preset state. This state is defined in **Table 1-1**.

When line power is cycled, or the **Preset** key pressed, the analyzer performs a self-test routine. Upon successful completion of that routine, the instrument state is set to the conditions shown in **Table 1-1**. The same conditions are true following a “PRES;” or “RST;” command over HP-IB, although the self-test routines are not executed.

You **also** can configure an instrument state and **define** it as your user preset state:

1. Set the instrument state to your desired preset conditions.
2. Save the state (save/recall menu).
3. Rename that register to “UPRESET”.
4. Press **Preset** **PRESET: USER**.

The **Preset** key is now toggled to the **USER** selection and your defined instrument state will be recalled each time you press **Preset** and when you turn power on. You can toggle back to the factory preset instrument state by pressing **Preset** and selecting **FACTORY**.

Note When you send a preset over HP-IB, you will always get the factory preset. You can, however, activate the user-defined preset over HP-IB by recalling the register in which it is stored.

Table 1-1. Preset Conditions (1 of 5)

Preset Conditions	Preset Value	Preset Conditions	Preset Value
Analyzer Mode		Start Power (HP 8719D/20D, Opt. 007)	-10.0 dBm
Analyzer Mode	Network Analyzer Mode	Start Power (BP 8719D/20D, Opt. 400)	-20.0 dBm
Frequency Offset (Opt. 089)	Off	Start Power (HP 8722D)	-20.0 dBm
Offset Value	0 Hz	Start Power (HP 8722D, Opt. 007)	-15.0 dBm
High Power (Opt. 085)		Start Power (HP 8722D, Opt. 400)	-25.0 dBm
External R Channel	Off	Power Span (HP 8719D/20D)	20 dB
Attenuator A	0 dB	Power Span (HP 8722D)	15 dB
Attenuator B	0 dB	Coupled Power	On
Stimulus Conditions		Source Power	On
Sweep Type	Linear Frequency	Coupled Channels	On
Step Sweep	off	Coupled Port Power	On
Step Sweep (Opt. 085)	on	Power Range	Auto; Range 0
Display Mode	Start/Stop	Power Range (Opt. 400)	Auto; Range 1
Trigger Type	Continuous	Number of Points	201
External Trigger	Off	Frequency List	
Sweep Time	100 ms, Auto Mode	Frequency List	Empty
Start Frequency	50 MHz	Edit Mode	Start/Stop, Number of Points
Stop Frequency (HP 8719D)	13.51 GHz	Response Conditions	
Stop Frequency (HP 8720D)	20.05 GHz	Parameter	Channel 1: S11; Channel 2: S21; Channel 3: S12; Channel 4: S22
Stop Frequency (HP 8722D)	40.05 GHz	Conversion	Off
Start Time	0	Format	Log Magnitude (all parameters)
Time Span	100 ms	Display	Data
CW Frequency	1 GHz	Color Selections	Same as before Preset
Test Port Power (HP 8719D/20D)	5 dBm	Dual Channel	Off
Test Port Power (HP 8719D/20D, Opt. 007)	10 dBm	Active Channel	Channel 1
Test Port Power (HP 8719D/20D, Opt. 400)	0 dBm		
Test Port Power (HP 8722D)	-10 dBm		
Test Port Power (HP 8722D, Opt. 007)	-5 dBm		
Start Power (HP 8719D/20D)	-15.0 dBm		

Table 12-3. Preset Conditions (2 of 5)

Preset Conditions	Preset Value	Preset Conditions	Preset Value
Frequency Blank	Disabled	Power Loss Correction	Off
Retrace Power	Standard	Sensor A/B	A
Test Set Switch	Continuous	Interpolated Error	On ¹
Test Set Switch (Opt. 007 or 085)	Hold	Correction	
Intensity	Factory set to 100%; user selected value is not changed by Preset .	Markers (coupled)	
Beeper: Done	On	Markers 1, 2, 3, 4, 5	1 GHz; All Markers Off
Beeper: Warning	Off	Last Active Marker	1
D2/D1 to D2	Off	Reference Marker	None
Title	Channel 1 = [hp] Channel 2 = Empty	Marker Mode	Continuous
IF Bandwidth	3000 Hz	Display Markers	On
IF Averaging Factor	16; off	Delta Marker Mode	Off
Smoothing Aperture	1% SPAN; Off	Coupling	On
Phase offset	0 Degrees	Marker Search	Off
Electrical Delay	0 ns	Marker Target Value	-3 dB
Scale/Division	10 dB/Division	Marker Width Value	-3 dB; Off
Calibration		Marker Tracking	Off
Correction	Off	Marker Stimulus Offset	0 Hz
Calibration Type	None	Marker Value Offset	0 dB
Calibration Kit (HP 8719D/20D)	3.5 mm	Marker Aux Offset (Phase)	0 Degrees
Calibration Kit (HP 8722D)	2.4 mm	Marker Statistics	Off
System Z0	50 ohms	Polar Marker	Lin Mkr
Velocity Factor	1	Smith Marker	R+jX Mkr
Extensions	Off	Limit Lines	Off
Port 1	0 s	Limit Testing	Off
Port 2	0 s	Limit List	Empty
Input A	0 s	Edit Mode	Upper/Lower Limits
Input B	0 s	Stimulus Offset	0 Hz
Chop A and B	on	Amplitude Offset	0 dB
Power Meter Calibration	Off	Limit Type	Sloping Line
Number of Readings	1	Beep Fail	Off

¹ Interpolated Error Correction can be on or off when the analyzer is in the factory preset state. The User's Guide describes how to set the factory preset state of Interpolated Error Correction.

Table 12-3. Preset Conditions (3 of 5)

Preset Conditions	Preset Value	Preset Conditions	Preset Value
Time Domain		Disk Save Configuration	
Transform	Off	(Define Store)	
Transform Type	Bandpass	Data Array	Off
Start Transform	-1 nanosecond	Raw Data Array	Off
stop Transform	4 nanoseconds	Formatted Data Array	Off
Gating	Off	Graphics	Off
Gate Shape	Normal	Data Only	Off
Gate Start	-500picosecond8	Directory Size	Default ¹
Gate Stop	500 picoseconds	Save Using	Binary
Demodulation	Off	Select Disk	InternalMemory
window	Normal	Disk Fbrmat	LIF
Use Memory	Off		
System Parameters		Sequencing²	
HP-IB Addresses	LastActiveBtate	LoopCounter	0
HP-IB Mode	Last Active State	ITL OUT	High
Focus	Last Active State	service Modes	
Clock Time Stamp	on	HP-IBDiagnostic	Off
Preset:Factory/User	Last Selected State	Source Phase Lock	Loop On
		Aux Input Resolution	Low
Copy Configuration		Analog Bus Node	11 (Aux Input)
Parallel Port	Last Active State		
Plotter Type	Last Active State	Plot	
Plotter Port	Last Active State	Plot Data	On
Plotter Baud Rate	LastActiveBtate	Plot Memory	On
Plotter Handshake	Last Active State	Plot Graticule	On
HP-IBAddress	Last Active State	Plot Text	On
Printer Type	LastActiveBtate	Plot Marker	On
Printer Port	Last Active State	Autofeed	On
Printer Baud Rate	Last Active State	Plot Quadrant	Full Page
Printer Handshake	Last Active State	kale Plot	Full
Printer HP-IB Address	LastActiveBtate	Plot.Speed	Fast

1 The directory size is calculated as 0.013% of the floppy disk size (which is ≈256) or 0.006% of the hard disk size.

2 Pressing preset turns off sequencing modify (edit) mode and stops any running sequence.

Table 12-3. Preset Conditions (4 of 5)

Preset Conditions	Preset Value	Preset Conditions	Preset Value
Pen Number:			
Ch1/Ch3 Data	2		
Ch1/Ch3 Memory	5	Print	
Ch1/Ch3 Marker	7	Printer Mode	Last Active State
Ch1/Ch3 Graticule	1	Auto-Feed	On
Ch1/Ch3 Text	7		
Ch2/Ch4 Data	3	Printer Colors	
Ch2/Ch4 Memory	6	CH1/Ch3 Data	Magenta
Ch2/Ch4 Graticule	1	CH1/Ch3 Mem	Green
Ch2/Ch4 Text	7	CH2/Ch4 Data	Blue
Ch2/Ch4 Marker	7	CH2/Ch4 Mem	Red
Line Type:		Graticule	Cyan
Ch1/Ch3 Data	7	Warning	Slack
Ch1/Ch3 Memory	7	Text	Black
Ch2/Ch4 Data	7	F&f Line	Black
Ch2/Ch4 Memory	7		

Table 12-3. Preset Conditions (5 of 5)

Format Table	Scale	Reference	
		Position	Value
Log Magnitude (dB)	10.0	5.0	0.0
Phase (degree)	90.0	5.0	0.0
Group Delay (ns)	10.0	5.0	0.0
Smith Chart	1.00		1.0
Polar	1.00		1.0
Linear Magnitude	0.1	0.0	0.0
Real	0.2	5.0	0.0
Imaginary	0.2	5.0	0.0
SWR	1.00	0.0	1.0

Analyzer Command Syntax

Code Naming Convention

The analyzer HP-IB commands are derived from their front-panel key titles (where possible), according to this naming convention:

Simple commands are the **first** four letters of the function they control, as in POWE, the command name for power. If the function label contains two words, the **first** three mnemonic letters are the **first** three letters of the **first** word, and the fourth mnemonic letter is the **first** letter of the second word. For example, ELED is derived from electrical delay.

If there are many commands grouped together in a category, as in markers or plotting pen numbers, the command is increased to 8 letters. The **first** 4 letters are the category label and the last 4 letters are the function specifier. As an example, category pen numbers are represented by the command PENN, which is used in combination with several functions such as PENNDATA, PENNMEMO.

The code naming guidelines, listed in **Table 1-2**, are used in order to:

- make commands more meaningful and easier to remember
- maintain compatibility with other products (including the HP 8510)

Note There are times when these guidelines are not followed due to technical considerations.

Table 1-2. Code Naming Convention

Convention	Key Title	For HP-IB Code Use	Example
One Word	Power Start	First Four Letters	POWE STAR
Two Words	Electrical Delay Search Right	First Three Letters of First Word, First Letter of Second Word	ELED SEAR
Two Words in a Group	Marker →Center Gate--span	Four Letters of Both	MARKCENT GATESPAN
Three Words	Cal Kit N 50 Ω Pen Num Data	First Three Letters of First Word, First Letter of Second Word, First Four Letters of Third Word	CALKN50 PENNDATA

Some codes require appendages (ON, OFF, 1, 2, etc). Codes that do not have a front-panel equivalent are HP-IB only commands They use a similar convention based on the common name of the function.

Valid Characters

The analyzer accepts the following ASCII characters:

- letters
- numbers
- decimal points
- +/-
- semicolons (;)
- quotation marks ("")
- carriage returns (CR)
- **linefeeds (LF)**

Both upper- and lower-case letters are acceptable. Carriage returns, leading zeros, spaces, and unnecessary terminators are ignored, except for those within a command or appendage. If the analyzer does not recognize a character as appropriate, it generates a syntax error message and recovers at the next terminator.

Units

The analyzer can input and output data in basic units such as Hz, **dB**, seconds, *etc.*

S	Seconds	Hz	Hertz
v	Volts	DB	dB or dBm

Input data is assumed to be in basic units (see above) unless one of the following **units** is used (upper and lower case are equivalent):

MS	Milliseconds	KHZ	Kilohertz
US	Microseconds	MHZ	Megahertz
NS	Nanoseconds	GHZ	Gigahertz
P S	Picoseconds	FS	Femtoseconds

Command Formats

The **HP-IB** commands accepted by the analyzer can be grouped into five input-syntax types
The analyzer does not **distinguish** between upper- and lower-case letters

General Structure:

The general syntax structure is: [code] [appendage] [data] [**unit**] [terminator]

The individual sections of the syntax code are explained below.

[code] The root mnemonic (these codes are described in the 'Alphabetical Mnemonic Listing' later in this chapter.)

[**appendage**] A **qualifier** attached to the root mnemonic Possible appendages are ON or OFF (toggle a function ON or OFF), or integers, which specify one capability out of several. There can be no spaces or symbols between the code and the appendage.

- [data]** A single operand used by the root mnemonic, usually to set the value of a function. The data can be a number or a character string. Numbers are accepted as integers or **decimals**, with power of ten **specified** by E (for example, STAR **0.2E+10** ; sets the start frequency to 2 **GHz**). Character strings must be enclosed by double quotation marks
For example:
 A title string using **RMB BASIC** would look like:
OUTPUT716;"TITL""Unit1"" ";
 where the first two "" are an escape so that RMB BASIC will interpret the third " properly.
- [unit]** The units of the operand, if applicable. If no units are specified, the analyzer **assumes** the basic units as described above. The data is entered into the function when either units or a terminator are received.
- [terminator]** Indicates the end of the command, enters the data, and switches the active-entry area OFF. A semicolon (;) is the recommended terminator.
Terminators are not necessary for the analyzer to interpret commands correctly, but in the case of a syntax error, the analyzer **will** attempt to recover at the next terminator. The analyzer also interprets line feeds and **HP-IB END OR IDENTIFY (EOI)** messages as terminators

Syntax Types

The specific syntax types are:

SYNTAX **TYPE 1:** [code] [terminator]

These are simple action commands that require no complementary information, such as **AUTO** ; (autoscales the active channel).

SYNTAX **TYPE 2:** [code][appendage][terminator]

These are simple action commands requiring limited **customization**, such as **CORRON** ; and **CORROFF** ; (error correction ON or OFF) or **RECA1** ;, **RECA2** ;, **RECA3** ; (recall register 1, 2, 3). There can be no characters or symbols between the code and the appendage.

Note In the **following** cases: **CLEAREG[D]**, **RECAREG[D]**, **SAVEREG[D]**, and **EG[D]**, [D] must be 2 characters For example, **CLEAREG01** ; will execute, while **CLEAREG1** ; will generate a syntax error.

SYNTAX **TYPE 3:** [code] [data] [unit][terminator]

These are data-input commands such as STAR 1.0 GHz ; (set the start frequency to 1 **GHz**).

SYNTAX **TYPE 4:** [code] [appendage] [data] [terminator]

These are titling and marker commands that have an appendage, such as **TITR1 "STATE1"** (title register 1 **STATE1**), **TITR2 "TEST2"** (title register 2 **TEST2**).

QUERY **SYNTAX:** [code][?]

To query a front-panel-equivalent **function**, append a question mark (?) to the root mnemonic (For example, **POWE?**, **AVERO?**, or **REAL?**.) **To** query commands with integer appendages, place the question mark after the appendage.

HP-IB Operation

The Hewlett-Packard Interface Bus (HP-IB) is Hewlett-Packard's hardware, software, documentation, and support for IEEE 488.2 and **IEC-625** worldwide standards for interfacing instruments. This interface allows you to operate the analyzer and peripherals in two methods:

- by an external system controller
- by the network analyzer in system-controller mode

Device Types

The HP-IB employs a party-line bus structure in which up to 15 devices can be connected on one contiguous bus. The interface consists of 16 signal lines and 8 ground lines within a shielded cable. With this cabling system, many different types of devices including instruments, computers, power meters, plotters, printers, and disk drives can be **connected in parallel**.

Every **HP-IB** device must be capable of performing one or more of the following interface functions:

Talker

A **talker** is a device capable of transmitting device-dependent data when addressed to talk. There can be only one active talker at any given time. Examples of this type of device include:

- power meters
- disk drives
- voltmeters
- counters
- tape readers

The network analyzer is a **talker** when it sends trace data or marker information over the bus.

Listener

A listener is a device capable of receiving device-dependent data over the interface when addressed to listen. There can be as many as 14 listeners connected to the interface at any given time. Examples of this type of device include:

- printers
- power supplies
- signal generators

The network **analyzer** is a listener when it is controlled over the bus by a system controller.

Controller

A controller is **defined** as a device capable of:

1. managing the operation of the bus
2. addressing talkers and listeners

There can be only one active controller on the interface at any time. Examples of controllers include desktop computers, minicomputers, workstations, and the network analyzer. In a **multiple-controller** system, active control can be passed between controllers, but there can only be one **system** controller connected to the interface. The system controller acts as the master and can regain active control at any time. The analyzer is an active controller when it plots, prints, or stores to an **external** disk drive in the pass-control mode. The analyzer is also a system controller when it is operating in the system-controller mode.

HP-IB Bus Structure

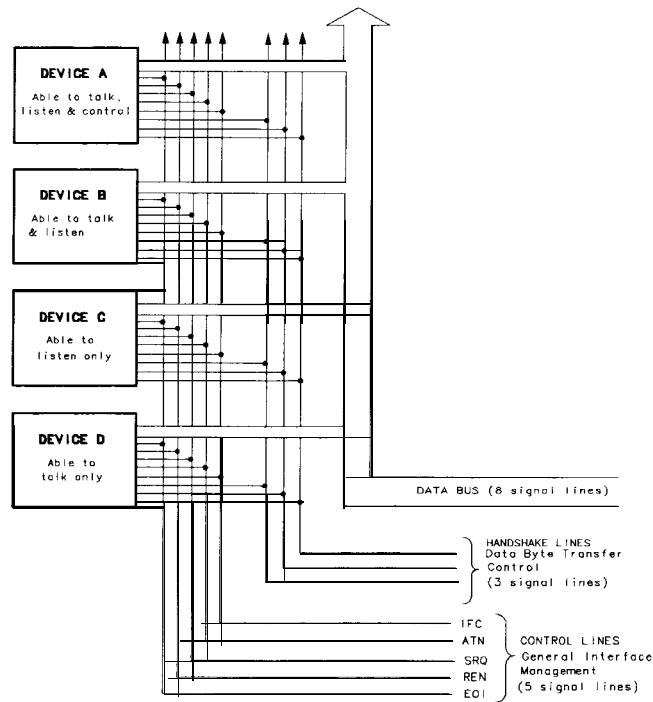

pg635d

Figure 1-1. **HP-IB** Bus Structure

Data Bus

The data bus consists of 8 bi-directional lines that are used to transfer data from one device to another. Programming commands and data transmitted on these lines are typically encoded in ASCII, although binary encoding is often used to speed up the transfer of large arrays. Both ASCII- and binary-data formats are available to the analyzer. In addition, every byte transferred over HP-IB undergoes a handshake to insure valid data.

Handshake Lines

A three-line handshake scheme coordinates the transfer of data between talkers and listeners. To insure data integrity in multiple-listener transfers, this technique forces data transfers to occur at the transfer rate of the slowest device connected to the interface. With most computing controllers and instruments, the handshake is performed automatically, making it transparent to the programmer.

Control Lines

The data bus **also** has five control lines. The controller uses these lines to address devices and to send bus commands.

IFC (Interface Clear)

This line is used exclusively by the system controller. When this line is true (low), all devices (whether addressed or not) unaddress and revert to an idle state.

ATN (Attention)	The active controller uses this line to define whether the information on the data bus is command-oriented or data-oriented. When this line is true (low), the bus is in the command mode, and the data lines carry bus commands. When this line is false (high), the bus is in the data mode, and the data lines carry device-dependent instructions or data.
SRQ (Service Request)	This line is set true (low) when a device requests service and the active controller services the requesting device. The network analyzer can be enabled to pull the SRQ line for a variety of reasons such as requesting control of the interface, for the purposes of printing, plotting, or accessing a disk.
REN (Remote Enable)	This line is used exclusively by the system controller. When this line is set true (low), the bus is in the remote mode, and devices are addressed by the controller to either listen or talk. When the bus is in remote mode and a device is addressed, it receives instructions from the system controller via HP-IB rather than from its front panel (pressing Local returns the device to front-panel operation). When this line is set false (high), the bus and all of the connected devices return to local operation.
EOI (End or Identify)	This line is used by a talker to indicate the last data byte in a multiple-byte transmission , or by an active controller to initiate a parallel-poll sequence. The analyzer recognizes the EOI line as a terminator, and it pulls the EOI line with the last byte of a message output (data, markers, plots, prints, error messages). The analyzer does not respond to parallel poll.

HP-IB Requirements

Number of Interconnected Devices:	15 maximum.
Interconnection Path Maximum Cable Length:	20 meters maximum or 2 meters per device (whichever is less).
Message Transfer Scheme:	Byte serial, bit parallel asynchronous data transfer using a 3-line handshake system.
Data Rate:	Maximum of 1 megabyte-per-second over the specified distances with tri-state drivers Actual data rate depends on the transfer rate of the slowest device connected to the bus
Address Capability:	Primary addresses: 31 talk , 31 listen. A maximum of 1 talker and 14 listeners can be connected to the interface at given time.
Multiple-Controller Capability:	In systems with more than one controller (such as this instrument), only one controller can be active at any given time. The active controller can pass control to another controller, but only the system controller can assume unconditional control. Only one system controller is allowed.

HP-IB Operational Capabilities

On the network analyzer's rear panel, next to the HP-IB connector, there is a list of HP-IB device subsets as **defined** by the IEEE 488.2 standard. The analyzer has the following capabilities:

- SH1** Pull-source handshake.
- AH1** Pull-acceptor handshake.
- T6** Basic talker, answers serial poll, unaddresses if MLA is issued. No talk-only mode.
- L4** Basic listener, unaddresses if MTA is issued. No listen-only mode.
- SR1** Complete service request (SRQ) capabilities.
- RL1** Complete remote/local capability including local lockout.
- PP0** Does not respond to parallel poll.
- DC1** Complete device clear
- DT1** Responds to a Group Execute Trigger (GET) in the hold-trigger mode.
- C1,C2,C3** System controller capabilities in system-controller mode.
- C10** Pass control capabilities in pass-control mode.
- E2** **Tri-state** drivers
- LE0** No extended listener capabilities.
- TE0** No extended talker capabilities

These codes are completely explained in the IEEE Std 488 documents, published by the Institute of Electrical and Electronic Engineers, Inc, 345 East **47th** Street, New York, New York 11017.

BP-IB Status Indicators

When the analyzer is connected to other instruments over the HP-IB, the HP-IB status indicators illuminate to display the current status of the analyzer. The HP-IB status indicators are located in the instrument-state function block on the front panel of the network analyzer.

R = Remote Operation

L = Listen mode

T = Talk mode

S = Service request (SRQ) asserted by the analyzer

Bus Device Modes

The analyzer uses a single-bus architecture. The single bus allows both the analyzer and the host controller to have complete access to the peripherals in the system.

Three different controller modes are possible in an HP-IB system:

- system-controller mode
- talker/listener mode
- pass-control mode

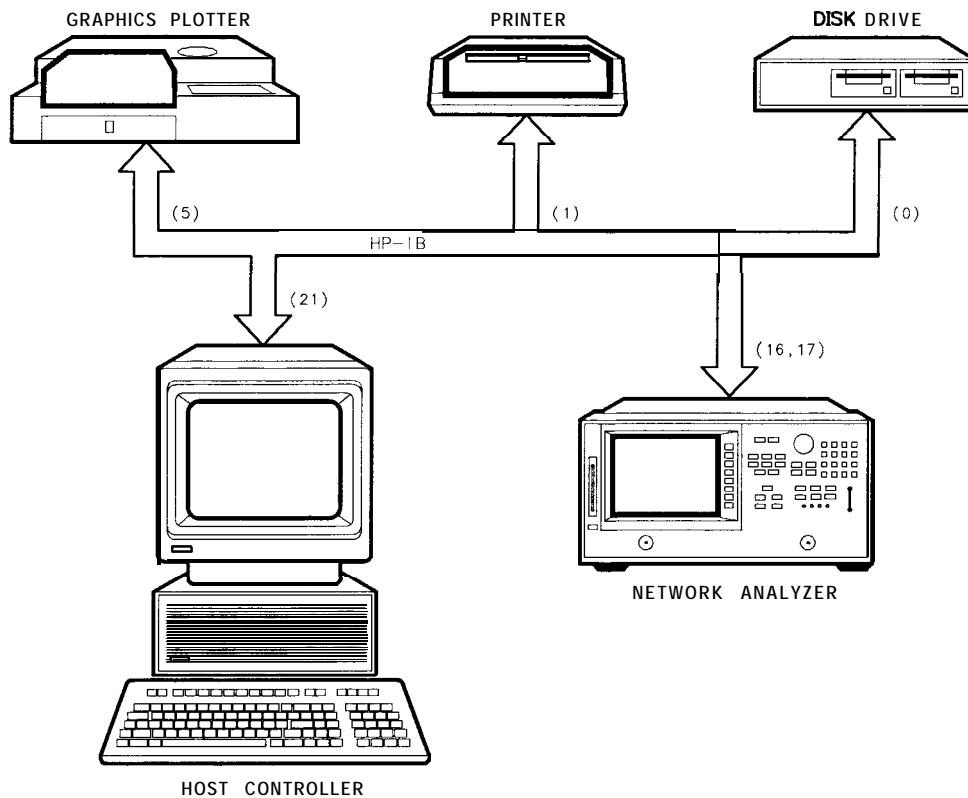

cb62d

Figure 1-2. Analyzer Single Bus Concept

System-Controller Mode

This mode allows the analyzer to control peripherals directly in a stand-alone environment (without an external controller). This mode can only be selected manually from the analyzer's front panel. It can only be used if no active computer or instrument controller is connected to the system via HP-IB. If an attempt is made to set the network analyzer to the system-controller mode when another controller is connected to the interface, the following message is displayed on the analyzer's display screen:

"ANOTHER SYSTEM CONTROLLER ON HP-IB BUS"

The analyzer must be set to the system-controller mode in order to access peripherals from the front panel. In this mode, the analyzer can directly control peripherals (plotters, printers, disk drives, power meters, etc) and the analyzer may plot, print, store on disk or perform power meter functions

Note Do not attempt to use this mode for programming. HP recommends using an external instrument controller when programming. See the following section, "Talker/Listener Mode."

Talker/Listener Mode

This is the mode that is normally used for remote programming of the analyzer. In talker/listener mode, the analyzer and all peripheral devices are controlled from an external instrument controller. The controller can command the analyzer to talk and other devices to listen. The analyzer and peripheral devices cannot talk directly to each other unless the computer sets up a data path between them. This mode allows the analyzer to act as either a talker or a listener, as required by the controlling computer for the particular operation in progress.

Pass-Control Mode

This mode **allows** the computer to control the analyzer via **HP-IB** (as with the talker/listener mode), but also **allows** the analyzer to take control of the interface in order to plot, print, or access a disk. During an analyzer controlled peripheral operation, the host computer is free to perform other internal tasks (i.e. data or display manipulation) while the analyzer is controlling the bus. After the analyzer-controlled task is completed, the analyzer returns control to the system controller.

Note Performing an instrument preset does not affect the selected bus mode, although the bus mode will return to talker/listener mode if the line power is cycled.

Note "Specifications and Measurement Uncertainties" in the *HP 8719D/20D/22D Network Analyzer User's Guide* provides information on setting the correct bus mode from the front-panel menu.

Analyzer Bus Modes

As discussed earlier, under **HP-IB** control, the analyzer can operate in one of three modes: talker/listener, pass-control, or system-controller mode.

In **talker/listener** mode, the analyzer behaves as a simple device on the bus. While in this mode, the analyzer can make a plot or print using the **OUTPLOT**; or **OUTPPRIN**; commands. The analyzer will wait until it is addressed to talk by the system controller and then dump the display to a plotter/printer that the system controller has addressed to listen. Use of the commands **PLOT**; and **PRINALL**; require control to be passed to another controller.

In pass-control mode, the analyzer can request control from the system controller and take control of the bus if the controller addresses it to take control. This allows the analyzer to take control of printers, plotters, and disk drives on an as-needed basis. The analyzer sets event-status register bit 1 when it needs control of the interface, and the analyzer will transfer control back to the system controller at the completion of the operation. It will pass control back to its controller address, specified by ADDRCONT.

The analyzer can also operate in the system-controller mode. This mode is only used when there is no remote controller on the bus. In this mode, the analyzer takes control of the bus, and uses it whenever it needs to access a peripheral. While the analyzer is in this mode, no other devices on the bus can attempt to take control. Specifically, the REN, **ATN**, and IFC lines must remain unasserted, and the data lines must be freed by **all** but the addressed **talker**.

Setting HP-IB Addresses

In systems interfaced using HP-IB, each instrument on the bus is **identified** by an **HP-IB** address. This address code must be different for each instrument on the bus. These addresses are stored in short-term, non-volatile memory and are not affected when you press **Preset** or cycle the power.

Note The analyzer occupies two HP-IB addresses: the instrument itself and the display. The display address is derived from the instrument address by complementing the instrument's least-significant bit. Hence, if the instrument is at an even address, the display occupies the next higher address. If the instrument is at an odd address, the display occupies the next lower address.

The analyzer addresses are set by pressing **Local** **SET ADDRESSES**. In system-controller mode, the addresses must be set for the plotter, printer, disk drive, and power meter.

The default address for the analyzer is device 16, and the display address is device 17.

Note There is also an address for the system controller. This address refers to the controller when the network analyzer is being used in pass-control mode. This is the address that control is passed back to when the analyzer-controlled operation is complete.

Response to HP-IB Meta-Messages (IEEE-488 Universal Commands)

Abort

The analyzer responds to the abort message (IFC) by halting all listener, talker, and controller functions.

Device Clear

The analyzer responds to the device clear commands (DCL, SDC) by clearing the input and output queues, and clearing any HP-IB errors. The status registers and the error queue are unaffected.

Local

The analyzer will go into local mode if the **local** command (GTL) is received, the remote line is unasserted, or the front-panel local key is pressed. Changing the analyzer's HP-IB status from remote to local does not affect any of the front-panel functions or values.

Local Lockout

If the analyzer receives the local-lockout command (**LLO**) while it is in remote mode, it will disable the entire front panel except for the line power switch. A local-lockout condition can only be cleared by releasing the remote line, although the local command (GTL) will place the instrument temporarily in local mode.

Parallel Poll

The analyzer does not respond to parallel-poll **configure** (PPC) or parallel-poll **unconfigure** (PPU) messages.

Pass Control

If the analyzer is in pass-control mode, is addressed to talk, and receives the take-control command (**TCT**), from the system control it will take active control of the bus. If the analyzer is not requesting control, it will immediately pass control to the system controller's address. Otherwise, the analyzer will execute the function for which it sought control of the bus and then pass control back to the system controller.

Remote

The analyzer will go into remote mode when the remote line is asserted and the analyzer is addressed to listen. While the analyzer is held in remote mode, **all** front-panel keys (with the exception of **Local**) are disabled. Changing the analyzer's HP-IB status from remote to local does not affect any front-panel settings or values.

Serial Poll

The analyzer will respond to a serial poll with its status byte, as **defined** in the "Status Reporting" section of this chapter. **To** initiate the serial-poll sequence, address the analyzer to talk and issue a **serial-poll** enable command (SPE). Upon receiving this command, the analyzer will return its status byte. End the sequence by issuing a serial-poll disable command (SPD). A serial poll does not affect the value of the status byte, and it does not set the instrument to remote mode.

Trigger

In hold mode, the analyzer responds to device trigger by taking a single sweep. The analyzer responds only to selected-device trigger (**SDT**). This means that it will not respond to group execute-trigger (GET) unless it is addressed to listen. The analyzer will not respond to GET if it is not in hold mode.

Analyzer Operation

Operation Complete

Occasionally, there is a need to know when certain analyzer operations have been completed. There is an operation-complete function (OPC) that **allows** a synchronization of programs with the execution of certain key commands. This mechanism is activated by issuing OPC ; or OPC? ; prior to an OPC-compatible command. The status byte or ESR operation-complete bit **will** then be set after the execution of the OPC-compatible command. For example, issuing OPC ; SING; causes the OPC bit to be set when the **single** sweep is **finished**. Issuing OPC? ; in place of the OPC ; causes the analyzer to output a one (1) when the command execution is complete. The analyzer **will halt** the computer by not transmitting the one (1) **until** the command has completed. For example, executing OPC? ; PRES ; , and then immediately querying the analyzer causes the bus to **halt until** the instrument preset is complete and the analyzer outputs a one (1).

As another example, consider the timing of sweep completion. Send the command string SWET 3 S; OPC? ; SING; to the analyzer. This string sets the analyzer sweep time to 3 seconds, and then waits for completion of a **single** sweep to respond with a one (1). The computer should be programmed to read the number one (1) response from the analyzer indicating completion of the **single** sweep. At this point a **valid** trace exists and the trace data **could** be read into the computer.

Table 1-3. OPC-compatible Commands

AUXC<ON OFF>	EXTTPOIN	RESPDONE
CHAN1	FREQOFFS<ON OFF>	REVI ²
CHAN2	FWDI ²	REVM ²
CHAN3 ¹	FWDM ²	REVT ²
CHAN4 ¹	FWDT ²	RST
CLASS11A ²	GATEO<ON OFF>	SAV1
CLASS11B ²	INSMNETA	SAV2
CLASS11C ²	INSMTUNR	SAVC
CLASS22A ²	ISOD	SAVE<1 to 5>
CLASS22B ²	MANTRIG	SAVEREG<01 to 31>
CLASS22C ²	NOOP	SAVT
CLEA<1 to 5>	NUMG	SING
CLEARALL	PRES	SLIS
CLEAREG<01 to 31>	RAID	STAN<A to G>
DATI	RECA<1 to 5>	SWPSTART
EXTTOFF	RECAREG<01 to 31>	TRAD
EXTTON	REFD	WAIT

¹ These commands are not querable, but the active channel may be found by OUTPCHAN.

² The class commands are OPC-compatible if there is only one standard in the class.

Reading Analyzer Data

Output Queue

Whenever an output-data command is received, the analyzer puts the data into the output queue (or buffer) where it is held until the system controller outputs the next read command. The queue, however, is only one event long: the next output-data command will overwrite the data already in the queue. Therefore, it is important to read the output queue immediately after every query or data request from the analyzer.

Command Query

All instrument functions can be queried to **find** the current ON/OFF state or value. For instrument state commands, append the question mark character (?) to the command to query the state of the functions. Suppose the operator has changed the power level from the analyzer's front panel. The computer can ascertain the new power level using the analyzer's command-query function. If a question mark is appended to the root of a command, the analyzer will output the value of that function. For instance, **POWE 7 DB ;** sets the source power to 7 **dB**, and **POWE? ;** outputs the current RF source power at the test port. When the analyzer receives **POWE? ;**, it prepares to transmit the current RF source power level. This condition **illuminates** the analyzer front-panel talk light (**T**). In this case, the analyzer transmits the output power to the controller.

ON/OFF commands can be also be queried. The reply is a one (1) if the function is ON or a zero (0) if it is OFF. For example, if a command controls an active function that is underlined on the analyzer display, querying that command yields a one (1) if the command is underlined or a zero (0) if it is not. As another example, there are nine options on the format menu and only one option is underlined at a time. Only the underlined option will return a one when queried.

For instance, send the command string **DUAC? ;** to the analyzer. If dual-channel display is switched ON, the analyzer will return a one (1) to the instrument controller.

Similarly, to determine if phase is being measured and displayed, send the command string **PHAS? ;** to the analyzer. In this case, the analyzer will return a one (1) if phase is currently being displayed. Since the command only applies to the active channel, the response to the **PHAS? ;** query depends on which channel is active.

Identification

The analyzer's response to **IDN? ;** is **HEWLETT PACKARD, 87NND, 0, X . XX** where **87NND** is the model number of the instrument and **X.XX** is the **firmware** revision of the instrument.

The analyzer also has the capability to output its serial number with the command **OUTPSEBN ;**, and to output its installed options with the command **OUTPOPTS ;**.

Output Syntax

The following three types of data are transmitted by the analyzer in ASCII format:

- response to query
- certain output commands
- ASCII floating-point (FORM 4) array transfers

Marker-output commands and queried commands are output in ASCII format only, meaning that each character and each digit is transmitted as a separate byte, leaving the receiving computer to reconstruct the numbers and strings. Numbers are transmitted as **24-character** strings, consisting of:

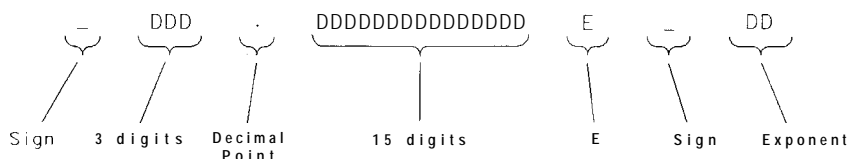

hg61a

Figure 1-3. FORM 4 (ASCII) Data-Transfer Character String

Sign	'-' for negative, blank for positive.
3 digits	Digits to the left of the decimal point.
Decimal point	Standard decimal point.
15 digits	Digits to the right of the decimal point.
E	Exponent notation.
Sign	'-' for negative, '+' for positive.
Exponent	Two digits for the exponent.

When multiple numbers are sent, the numbers are separated by commas. When number pairs are sent, the numbers are separated by a comma and terminated with a line feed (LF).

Marker data

The network analyzer offers several options for outputting trace-related data. Trace information can be read out of the analyzer in several methods. Data can be selectively read from the trace using the markers, or the entire trace can be read by the controller. If only specific information is required (such as a single point on the trace or the result of a marker search), the marker output command can be used to read the information. **Specific** data points can be read using the **OUTPDATP** or **OUTPDATR** commands. These commands allow a much faster data transfer than when using markers to output **specific** data points. For more information on these commands, see "Limit Line and Data Point **Special** Functions," located in Chapter 2.

To read the trace data using the marker, the marker must **first** be assigned to the desired frequency. This is accomplished using the marker commands. The controller sends a marker command followed by a frequency within the trace-data range. If the actual desired frequency was not sampled, the markers can be set to continuous mode and the desired marker value will be linearly interpolated from the two nearest points. This interpolation can be prevented by putting the markers into discrete mode. Discrete mode allows the marker to only be positioned on a measured trace-data point.

As an alternative, the analyzer can be programmed to choose the stimulus value by using the **MARKER SEARCH** function. Maximum, minimum, target value, or bandwidths search can be **automatically** determined with **MARKER SEARCH**. **To** continually update the search, switch the marker tracking **ON**. The trace-maximum search will remain activated until:

- The search is switched **OFF**.
- The tracking is switched **OFF**.

- All markers are switched OFF.

Marker data can be output to a controller with a command to the analyzer. This set of commands causes the analyzer to transmit three numbers: marker **value 1**, marker value 2, and marker stimulus value. For example, in log-magnitude display mode we get the log magnitude at the marker (**value 1**), zero (for value 2), and the marker frequency. See **Table 1-4** for a complete listing of **all** the possibilities for values 1 and 2. The three possibilities for the marker stimulus value are:

- frequency
- time (as in time domain, Option 010 Only)
- **CW time**
- power (in power sweep mode)

Table 1-4. Units as a Function of Display Format

Display Format	Marker Mode	OUTPMARK		OUTPFORM		MARKER READOUT*	
		value 1	value 2	value 1	value 2	value	aux value
LOG MAG		dB	t	dB	t	dB	t
PHASE		degrees	t	degrees	t	degrees	t
DELAY		seconds	t	seconds	t	seconds	t
SMITH CHART	LIN MKR	lin mag	degrees	real	imag	lin mag	degrees
	LOG MKR	dB	degrees	real	imag	dB	degrees
	Re/Im	real	imag	real	imag	real	imag
	R + jX	real ohms	imag ohms	real	imag	real ohms	imag ohms
	G + jB	real Siemens	imag Siemens	real	imag	real Siemens	imag Siemens
POLAR	LIN MKR	lin mag	degrees	real	imag	lin mag	degrees
	LOG MKR	dB	degrees	real	imag	dB	degrees
	Re/Im	real	imag	real	imag	real	imag
LIN MAG [§]		lin mag	t	lin mag	t	lin mag	t
SWR		SWR	t	SWR	t	SWR	t
REAL		real	t	real	t	real	t
IMAGINARY		imag	t	imag	t	imag	t

*The marker readout values are the marker values displayed in the upper right-hand corner of the display. They also correspond to the value and auxiliary value associated with the fixed marker.

†Value 2 is not significant in this format, though it is included in data transfers. See also OUTPFORM.

§LIN MAG data expressed as: "Watts," for single input measurements (A,B,R), and "Units," for ratioed measurements (A/R, B/R).

Array-Data Formats

The analyzer can transmit and receive arrays in the analyzer's internal binary format as well as four different numeric formats. The current format is set with the **FORM1**, **FORM2**, **FORM3**, **FORM4**, and **FORM5** commands. These commands do not affect learn-string transfers, calibration-kit string transfers, or non-array transfers, such as command query, or output marker values.

A transmitted array will be output in the current format, and the analyzer **will** attempt to read incoming arrays according to the current format. Each data point in an array is a pair of numbers, **usually** a real/imaginary pair. The number of data points in each array is the same as the number of points in the current sweep.

The five formats are described below:

- FORM1** The analyzer's internal binary format, 6 bytes-per-data point. The array is preceded by a four-byte header. The first two bytes represent the string "**#A**", the standard block header. The second two bytes are an integer representing the number of bytes in the block to **follow**. FORM 1 is best applied when rapid data transfers, not to be modified by the computer nor interpreted by the user, are required.
- FORM2** IEEE **32-bit** floating-point format, 8 bytes-per-data point. The data is preceded by the same header as in **FORM1**. Each number consists of a 1-bit sign, an 8-bit biased exponent, and a **23-bit** mantissa. FORM 2 is the format of choice if your computer supports single-precision floating-point numbers.
- FORM3** IEEE **64-bit** floating-point format, 16 bytes-per-data point. The data is preceded by the same header as in FORM 1. Each number consists of a 1-bit sign, an **11-bit** biased exponent, and a **52-bit** mantissa. This format may be used with double-precision floating-point numbers. No additional precision is available in the analyzer data, but FORM 3 may be a convenient form for transferring data to your computer.
- FORM4** ASCII floating-point format. The data is transmitted as ASCII numbers, as described in "Output Syntax".
- There is no header. The analyzer always uses FORM 4 to transfer data that is not related to array transfers (i.e. marker responses and instrument settings).
- FORM5** PC-DOS **32-bit** floating-point format with 4 bytes-per-number, 8 bytes-per-data point. The data is preceded by the same header as in FORM 1. The byte order is reversed to comply with PC-DOS formats. If you are using a PC-based controller, FORM 5 is the most effective format to use.

The **analyzer** terminates each **transmission** by asserting the EOI interface line with the last byte transmitted. Table **1-5** offers a comparative overview of the five array-data formats.

Table 1-5 HP 8719D/20D/22D Network Analyzer Array-Data Formats

Format type	Type of Data	Bytes per Data Value	Bytes per point 2 data values	(201 pts) Bytes per trace	Total Bytes with header
FORM 1	Internal Binary	3	6	1206	1210
FORM 2	IEEE 32-bit Floating-Point	4	8	1608	1612
FORM 3	IEEE 64-bit Floating-Point	8	16	3216	3220
FORM 4	ASCII Numbers	24 (Typical)	50 (Typical)	10,050 (Typical)	10,050* (Typical)
FORM 5	PC-DOS 32-bit Floating-Point	4	8	1608	1612

'No header is used in FORM 4.'

Trace-Data Transfers

Transferring trace-data from the analyzer using an instrument controller can be divided into three steps:

1. allocating an array to receive and store the data
2. commanding the analyzer to transmit the data
3. accepting the transferred data

Data residing in the analyzer is always stored in pairs for each data point (to accommodate real/imaginary pairs). Hence, the receiving array has to be two elements wide, and as deep as the number of points in the array being transferred. Memory space for the array must be declared before any data can be transferred from the analyzer to the computer.

As mentioned earlier, the analyzer can transmit data over HP-IB in five different formats. The type of format affects what kind of data array is declared (real or integer), because the format determines what type of data is transferred. Examples of data transfers using different formats are discussed "Example 3: Measurement Data Transfer." For information on the various types of data that can be obtained (raw data, error-corrected data, etc), see "Data Levels," located later in this chapter.

For information on transferring trace-data by selected points, see "Limit Line and Data Point Special **Functions**," located in Chapter 2.

Note "Example 7C: Reading ASCII Disk Files to the Instrument Controller's Disk File," located in Chapter 2, explains how to access disk **files** from a computer.

Stimulus-Related Values

Frequency-related values are calculated for the analyzer display. The start and stop frequencies or center and span frequencies of the selected frequency range are available to the programmer.

In a linear frequency range, the frequency values can be easily calculated because the trace data points are equally spaced across the trace. Relating the data from a linear frequency sweep to frequency can be done by querying the start frequency, the frequency span, and the number of points in the trace.

Given that information, the frequency of point n in a linear-frequency sweep is represented by the equation:

$$F = \text{Start frequency} + (n-1) \times \text{Span}/(\text{Points}-1)$$

In most cases, this is an easy solution for determining the related frequency **value** that corresponds with a data point. This technique is illustrated in “Example **3B**: Data Transfer Using FORM 4 (ASCII Format).”

When using log sweep or a list-frequency sweep, the points are not evenly spaced over the frequency range of the sweep. In these cases, an effective way of determining the frequencies of the current sweep is to use the OUTPLIML command. Although this command is normally used for limit lines, it can also be used to identify all of the frequency points in a sweep. Limit lines do not need to be on in order to read the frequencies directly out of the instrument with the OUTPLIML command. Refer to example **3D**, “Data Transfer Using Frequency Array Information. ”

Note Another method of identifying all of the frequency points in a sweep is to use the marker commands MARKBUCK x and OUTPMARK in a FOR NEXT programming loop that corresponds to the number of points in the sweep. MARKBUCK x places a marker at a point in the sweep, where x is the number of the point in a sweep, and OUTPMARK outputs the **stimulus** value as part of the marker data.

Data-Processing Chain

This section describes the manner in which the analyzer processes measurement data. It includes information on data arrays, common output commands, data levels, the learn string, and the calibration kit string.

Data Arrays

Figure 1-4 shows the different kinds of data available within the instrument:

- pre-raw measured data
- raw measured data
- error-corrected data
- formatted data
- trace memory
- calibration coefficients

Trace memory can be directly output to a controller with **OUTPMEMO;**, but it cannot be directly transmitted back.

One channel shown.

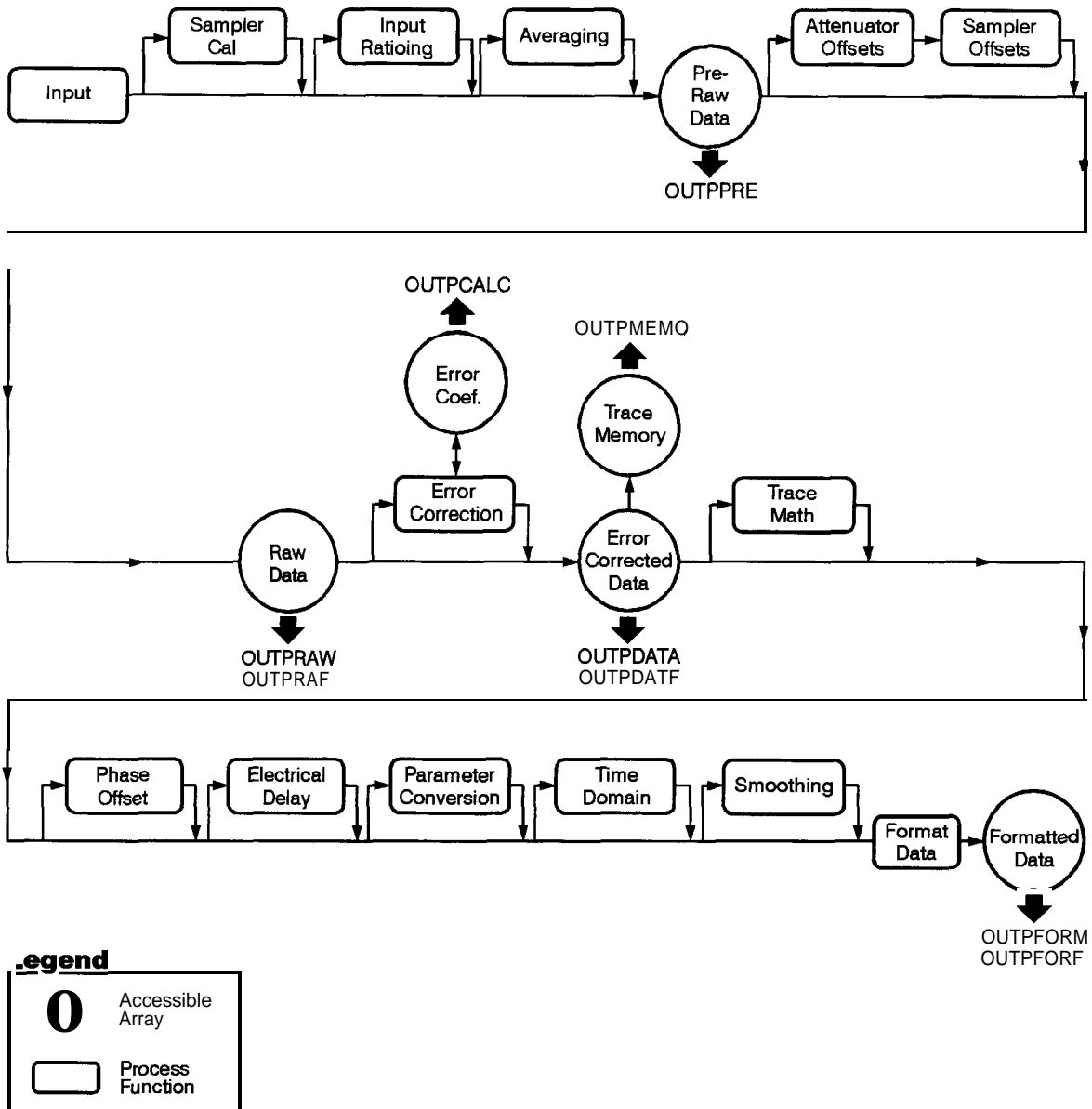

cg66d

Figure 1-4. The Data-Processing Chain

All the data-output commands are designed to insure that the data transmitted reflects the current state of the instrument:

- OUTPDATA, OUTPRAW<I>, OUTPFORML, OUTPDATF, OUTPRAF<I> and OUTPFORF will not transmit data until all formatting functions have completed.
- OUTPPRE transmits data in conjunction with **Take4** mode and the SWPSTART command. See Programming Example 2E: **Take4** — Error Correction Processed on an External PC.
- OUTPLIML, OUTPLIMM, and OUTPLIMF will not transmit data until the limit test has occurred (if activated).

- **OUTPMARK** will activate a marker if a marker is not already selected. It will also insure that any current marker searches have been completed before transmitting data.
- **OUTPMSTA** insures that the statistics have been calculated for the current trace before transmitting data. If the statistics are not activated, it will activate the statistics long enough to update the current values before deactivating the statistics
- **OUTPMWID** insures that a bandwidth search has been executed for the current trace before transmitting data. If the bandwidth-search function is not activated, it will activate the bandwidth-search function long enough to update the current values before switching OFF the bandwidth-search functions

Fast Data Transfer Commands

The HP 8753D has four distinct fast data transfer **commands**. These commands circumvent the internal “byte handler” routine and output trace dumps as block data. In other words, the analyzer outputs the entire array without allowing any process swapping to occur **FORM4**, ASCII data transfer times are not affected by these routines. However, there are speed improvements with binary data formats The following is a description of the four fast data transfer commands:

- **OUTPDATF** outputs the error corrected data from the active channel in the current output format. This data may be input to the analyzer using the **INPU**DATA command.
- **OUTPFORF** outputs the formatted display trace array from the active channel in the current output format, but only the first number in each of the **OUTPF'ORM** data pairs is actually **transferred for the display formats LOG MAG, PHASE, group DELAY, LIN MAG, SWR, REAL** and **IMAGinary**. Because the data array does not contain the second value for these display formats, the **INPUFORM** command may not be used to re-input the data back into the **analyzer**. The second value may not be **significant** in some display formats (see **Table 1-4**), thus eliminating it reduces the number of bytes transferred.
- **OUTPMEMF** outputs the memory trace from the active channel. The data is in real/ii pairs, and, as such, may be input back into the memory trace using **INPU**DATA or **INPUFORM** followed by the **DATI** command.
- **OUTPRAF<I>** outputs the raw measurement data trace The data may be input back into the memory trace using the **INPURAW<I>** command.

Data Levels

Different levels of data can be read out of the **instrument**. Refer to the data-processing chain in Figure 14. **The** following list describes the different types of data that are available from the network **analyzer**.

Pre-raw data	This is the raw data without attenuator offsets applied. With raw offsets turned off, the calibration coefficients generated can be transferred to an external controller and used with the data gathered using the OUTPPRE[1-4] commands See Programming Example 2E: Take4 — Error Correction Processed on an External Computer. The four arrays refer to S11 , S21 , S12 and S22 respectively. These four arrays are available only if 2-port correction or Take4 mode is on. This data is represented in real/imaginary pairs
Raw data	The basic measurement data, reflecting the stimulus parameters, IF averaging, and IF bandwidth. If a full 2-port measurement calibration is activated, there are actually four

	raw arrays kept: one for each raw S-parameter. The data can be output to a controller with the commands OUTPRAW1 , OUTPRAW2 , OUTPRAW3 , OUTPRAW4 . Normally, only raw 1 is available, and it holds the current parameter. If a 2-port measurement calibration is active, the four arrays refer to S₁₁ , S₂₁ , S₁₂ , and S₂₂ respectively. This data is represented in real/imaginary pairs
Error-corrected data	This is the raw data with error-correction applied. The array represents the currently measured parameter, and is stored in real/imaginary pairs. The error-corrected data can be output to a controller with the OUTPDATA ; command. The OUTPMEHO ; command reads the trace memory, if available. The trace memory also contains error-corrected data. Note that neither raw nor error-corrected data reflect such post-processing functions as electrical-delay offset, trace math, or time-domain gating .
Formatted data	This is the array of data actually being displayed. It reflects all post-processing functions such as electrical delay and time domain. The units of the array output depend on the current display format. See Table 1-4 for the various units defined as a function of display format.
Calibration coefficients	The results of a measurement calibration are arrays containing calibration coefficients. These calibration coefficients are then used in the error-correction routines. Each array corresponds to a specific error term in the error model. The HP 87530 <i>Network Analyzer User's details</i> which error coefficients are used for specific calibration types, as well as the arrays those coefficients can be found in. Not all calibration types use all 12 arrays The data is stored as real/imaginary pairs

Generally, formatted data is the most useful of the five data levels, because it is the same information the operator sees on the display. However if post-processing is unnecessary (e.g. possibly in cases involving smoothing), error-corrected data may be more desirable. Error-corrected data also affords the user the opportunity to input the data to the network analyzer and apply post-processing at another time.

Learn String and Calibration-Kit String

The learn string is a **summary** of the instrument state. It includes all the front-panel settings, the limit-test tables, and the list-frequency table for the current instrument state. It does not include calibration data or the information stored in the save/recall registers.

The learn string can be output to a controller with the **OUTPLEAS ;** command, which commands the analyzer to start transmitting the binary string. The string has a **fixed** length for a given firmware revision. The array has the same header as in FORM 1. See Example 5, "Using the **Learn String**."

The calibration kit includes a set of key characteristics of the calibration standards used to determine the calibration accuracy. There are default kits for several different connector types. There is also space for a user-defined calibration kit. The command **OUTPCALK** outputs the currently active calibration kit as a binary string in FORM 1. As with the learn string, the calibration-kit string has a fixed length for a given **firmware** revision.

Error Reporting

This section describes the analyzer's error-reporting process. It includes information on status reporting, the status byte, the event-status registers, and the error output.

Status Reporting

The analyzer status reporting structure is depicted in Figure 1-5. Refer to Table 1-6 for a description of each bit within the status reporting structure.

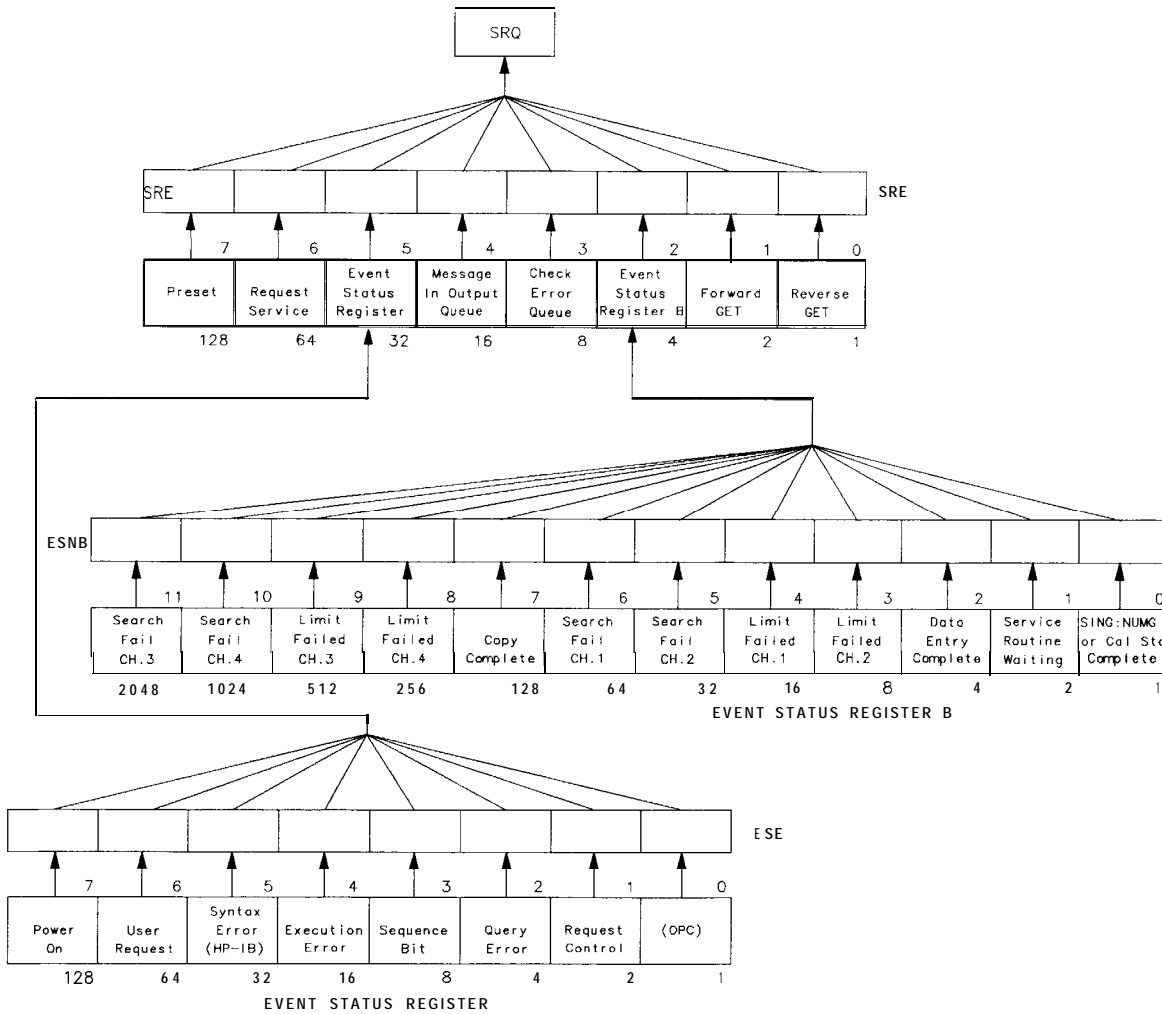

cb67d

Figure 1-5. Status Reporting Structure

Table 1-6. Status Bit Definitions

Status Byte		
Bit	Name	Definition
0	Waiting for reverse GET	Not applicable for the HP 8719D/20D/22D.
1	Waiting for forward GET	Not applicable for the BP 8719D/20D/22D.
2	Check event-status register B	One of the enabled bits in event status register B has been set.
3	Check error queue	An error has occurred and the message has been placed in the error queue, but has not been read yet.
4	Message in output queue	A command has prepared information to be output, but it has not been read yet.
5	Check event-status register	One of the enabled bits in the event-status register has been set.
6	Request service	One of the enabled status-byte bits is causing SRQ.
7	Preset	An instrument preset has been executed.
Event-Status Register		
Bit	Name	Definition
0	Operation complete	A command for which OPC has been enabled has completed operation.
1	Request control	The analyzer has been commanded to perform an operation that requires control of a peripheral, and needs control of HP-IB. Requires pass-control mode.
2	Query error	The analyzer has been addressed to talk but there is nothing in the output queue to transmit.
3	Sequence Bit	A sequence has executed the assert SRQ command.
4	Execution error	A command was received that could not be executed.
5	Syntax error	The incoming HP-IB commands contained 8 syntax error. The syntax error can only be cleared by a device clear or an instrument preset.
6	User request	The operator has pressed a front-panel key or turned the RPG.
7	Power on	A power-on sequence has occurred since the last read of the register.
Event-Status Register B		
Bit	Name	Definition
0	Single sweep, number of groups, or calibration step complete	A single sweep, group, or calibration step has been completed since the last read of the register.
1	Service routine waiting or done	An internal service routine has completed operation, or is waiting for an operator response.
2	Data entry complete	A terminator key has been pressed or a value entered over HP-IB since the last read of the register.
3	Limit failed, Channel 2	Limit test failed on Channel 2.
4	Limit failed, Channel 1	Limit test failed on Channel 1.
5	Search failed, Channel 2	A marker search was executed on Channel 2, but the target value was not found.
6	Search failed, Channel 1	A marker search was executed on Channel 1, but the target value was not found.
7	Copy Complete	A copy has been completed since the last read of the register.

Table 1-7. Status Bit Definitions (Continued)

Event Status Register B (Continued)		
Bit	Name	Definition
8	Limit failed, Channel 4	Limit test failed on channel 4.
9	Limit failed, Channel 3	Limit test failed on channel 3.
10	Search failed, Channel 4	A marker search was executed on Channel 4, but the target value was not found.
11	Search failed, Channel 3	A marker search was executed on Channel 3, but the target value was not found.

The Status Byte

The analyzer has a status-reporting mechanism that reports information about specific analyzer functions and events. The status byte (consisting of summary bits) is the top-level register. Each bit reflects the condition of another register or queue. If a summary bit is set (equals 1), the corresponding register or queue should be read to obtain the status information and clear the condition. Reading the status byte does not affect the state of the summary bits. The summary bits always reflect the condition of the summarized queue or register. The status byte can be read by a serial poll or by using the command `OUTPSTAT`. When using this command, the sequencing bit can be set by the operator during the execution of a test sequence. `OUTPSTAT` does not automatically put the instrument in remote mode, thus giving the operator access to the analyzer front-panel functions.

The status byte:

- summarizes the error queue
- summarizes two event-status registers that monitor **specific** conditions inside the instrument
- contains a bit that is set when the instrument is issuing a service request (SRQ) over HP-IB
- contains a bit that is set when the analyzer has data to transmit over HP-IB

Any bit in the status byte can be selectively enabled to generate a service request (SRQ) when set. Setting a bit in the service-request-enable register with the `SREnn ;` command enables the corresponding bit in the status byte. The units variable *nn* represents the binary equivalent of the bit in the status byte. For example, `SRE24 ;` enables status-byte bits 3 and 4 (since $2^3 + 2^4 = 24$) and disables all the other bits. `SRE` will not affect the state of the status-register bits.

The status byte also summarizes two queues: the output queue and the error queue. (The error queue is described in the next section.) When the analyzer outputs information, it puts the information in the output queue where it resides until the controller reads it. The output queue is only one event long. Therefore, the next output request will clear the current data. The summary bit is set whenever there is data in the output queue.

The Event-Status Register and Event-Status Register B

The event-status register and event-status register B are the other two registers in the status-reporting structure. They are selectively summarized by bits in the status byte via enable registers. The event-status registers consist of latched bits. A latched bit is set at the beginning of a specific trigger condition in the instrument. It can only be cleared by reading the register. The bit will not be reactivated until the condition occurs again. If a bit in one of these two registers is enabled, it is summarized by the summary bit in the status byte. The registers are enabled using the commands `ESEnn ;` and `ESNBnn ;`, both of which work in the same manner as `SREnn`. The units variable *nn* represents the binary equivalent of the bit in the status byte.

If a bit in one of the event-status registers is enabled, and therefore, the summary bit in the status byte is enabled, an SRQ will be generated. The SRQ will not be cleared until one of the five following conditions transpire:

1. The event-status register is read, clearing the latched bit.
2. The summary bit in the status byte is disabled.
3. The event-status register bit is disabled.
4. The status registers are cleared with the CLES ; command.
5. An instrument preset is performed.

Service requests generated when there are error messages or when the instrument is waiting for the Group Execute Trigger (GET) command are cleared by:

- reading the errors
- issuing GET (disabling the bits)
- clearing the status registers

Error Output

When an error condition is detected in the analyzer, a message is generated, displayed on the analyzer's display screen, and placed in the error queue. Error messages consist of an error number followed by an ASCII string no more than **50-characters** long. The string contains the same message that appears on the analyzer's display. The error queue holds up to 20 error messages in the order in which they occur. The error messages remain in the error queue until the errors are read by the system controller using the command OUTPERRO. The OUTPERRO command outputs one error message.

Note The error queue can only be cleared by performing an instrument preset or by cycling the line power. In order to keep the queue up-to-date, it is important to read all of the messages out of the queue each time errors are detected.

Calibration

Measurement calibration over **HP-IB** follows the same command sequence as a calibration from the front-panel. For detailed information, refer to "Optimizing Measurement Results" in the *HP 8719D/20D/22D Network Analyzer User's Guide*.

1. Start by selecting a calibration kit, such as 50 ohm type N. (**CALKN50** ;)
2. Select a calibration type, such as **S11** 1-port (**CALIS111** ;).
3. **Call each class used by the calibration type, such as **FORWARD: OPEN** (CLASS 11A ;)** During a **2-port** calibration, the reflection, transmission, and isolation subsequences must be opened before the classes in the subsequence are called, and then closed at the end of each subsequence.
4. If a class has more than one standard in it, select a standard from the menu presented (**STANA** to STANG).
5. If, during a calibration, two standards are measured to satisfy one class, the class must be closed with **DONE** ; .
6. **Declare the calibration done, such as with **DONE 1-PORT CAL** (SAV1 ; over HP-IB).**

The **STANA** to STANG commands will hold off the **HP-IB** until completion because they trigger a sweep. If a class has only one standard in it, which means that it will trigger a sweep when called, the class command will also hold off the **HP-IB**.

Note Since different **cal** kits can have a different number of standards in a given class, any automated calibration sequence is valid only for a specific **cal** kit.

Table 1-8. Relationship between Calibrations and Classes

Class	Response	Response and Isolation	S11 1-port	S22 1-port	One path 2-port	Full 2-port	TRL/LRM
Reflection: ¹					•	•	•
S11A, RE FW MTCH			•		•	•	•
S11B, LN FW MTCH			•		•	•	•
S11C, LN FW TRAN			•		•	•	•
S22A, LN RV MTCH				•		•	•
S22B, LN RV TRAN				•		•	•
S22C, LN RV TRAN				•		•	•
Transmission: ¹					•	•	•
Forward match					•	•	•
Forward trans					•	•	•
Reverse match						•	•
Reverse trans						•	•
Isolation: ¹					•	•	•
Forward					•	•	•
Reverse						•	•
Response	•						
Response and isolation:							
Response		•					
Isolation		•					
TRL thru: ²							•
TRL reflect: ²							•
TRL line or match: ²							•

1 These subheadings must be called when doing full 2-port calibrations.

2 These subheadings must be called when doing TRL 2-port calibrations.

Table 1-9. Error Coefficient Arrays

Array	Response	Response and Isolation	1-port	2-port ¹	TRL/LRM
1	E _R or E _T	E _X (E _D) ² E _T (E _R)	E _D	E _{DF}	E _{DF}
2			E _S	E _{SF}	E _{SF}
3			E _R	E _{RF}	E _{RF}
4			E _{XF}	E _{XF}	
5			E _{LF}	E _{LF}	
6			E _{TF}	E _{TF}	
7			E _{DR}	E _{DR}	
8			E _{SR}	E _{SR}	
9			E _{RR}	E _{RR}	
10			E _{XR}	E _{XR}	
11			E _{LR}	E _{LR}	
12			E _{TR}	E _{TR}	

1 One path, 2-port cal duplicates arrays 1 to 6 in arrays 7 to 12.

2 Response and isolation corrects for crosstalk and transmission tracking in transmission measurements, and for directivity and reflection tracking in reflection measurements.

Meaning of first subscript:

- D = directivity
- S = source match
- R = reflection tracking
- X** = crosstalk or isolation
- L = load match
- T = transmission tracking

Meaning of second subscript:

- F** = forward
- R = reverse

Disk File Names

Disk files created by the analyzer consist of a state name of up to eight characters, such as **FILTER**, appended with up to two characters. In **LIF** format, the file name is **FILTERXX**. In DOS format, the filename is **FILTER.XX**. The first appended character is the file type, telling the kind of information in the file. The second appended character is a data index, used to distinguish files of the same type.

Error corrected data, raw data, formatted data, memory traces, and calibration files are FORM 3 data files (IEEE 64-bit floating point format). The other files are not meant to be decoded. Table 1-10 lists the appended characters and their meanings

Table 1-10. Disk File Names

Char 1	Meaning	Char 2	Meaning
I, P	Instrument state		
W	Four-channel instrument state		
G	Graphics	1	Display graphics
D	Error corrected data	1	Channel 1
		2	Channel 2
		3	Channel 3
		4	Channel 4
R	Raw data	1 to 4	Ch1/Ch3, raw arrays 1 to 4
		5 to 8	Ch2/Ch4, raw arrays 5 to 8
F	Formatted data	1	Channel 1
		2	Channel 2
		3	Channel 3
		4	Channel 4
M	Memory trace	1	Channel 1
		2	Channel 2
		3	Channel 3
		4	Channel 4
C	Cal kit	K	
1	Cal data, channel 1	0	Stimulus state
		1 to 9	Coefficients 1 to 9
		A	Coefficient 10
		B	Coefficient 11
		C	Coefficient 12
2	Cal data, channel 2	0 to C	Same as channel 1
F	Full page (HP-GL plot)	P	
L	Left (HP-GL plot)	L	Lower
		U	Upper
R	Right (HP-GL plot)	L	Lower
		U	Upper
S	Error corrected data (S2P)	1	Channel 1
		2	Channel 2

Using Key Codes

Using key codes **allows** remote control of the analyzer keys and can be used as an alternative to using other HP-IB commands. This may be **useful**, but it is a **highly** recommended programming practice to use the HP-IB command mnemonic appropriate for the function desired.

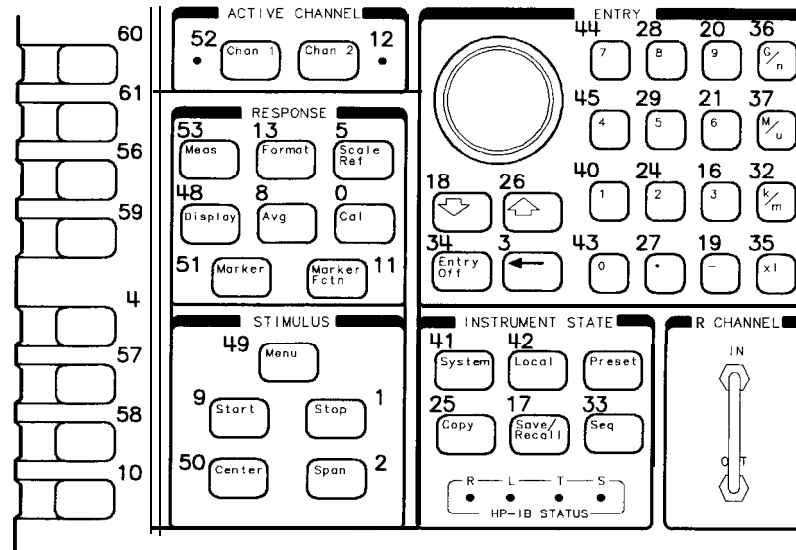

cb61d

Figure 1-6. Key Codes

When using key codes, the following notes must be taken into consideration:

- Note 1:** An "invalid key" is reported with a 63.
- Note 2:** **OUTPKEY**; outputs the key code of the last key pressed. This command reports a **knob turn as a -1**.
- Note 3:** **KOR?**; outputs the last key code or knob count. If the reply is positive, it is a key code. If it is negative, then set bit 15 equal to bit 14, and the **resulting** two byte integer is the **RPG** knob count. It can be either positive or negative. There are about 120 counts per turn.

Key Select Codes for the Network Analyzer

The HP-IB mnemonics in the following table are **functionally** arranged by their front-panel key equivalent. For example, all of the mnemonics that correspond to **softkeys** accessed by means of the **Cal** key, will be listed under the **Cal** key in the following table.

Keys

AVG
CAL-Error correction, calibration
CAL-Calibration kits
CAL-Power Meter Calibration
CHANNEL
COPY
DISPLAY
ENTRY
FORMAT
LOCAL

MEAS

MENU (stimulus)
MARKER
MARKER FCTN
SAVE/RECALL-Internal registers
SAVE/RECALL-Disk files
SCALE REF
SEQ-Sequencing
STIMULUS

SYSTEM

SYSTEM-Limit testing
SYSTEM-Transform

Column headings:

Function	The front-panel function affected by the mnemonic
Action	The effects of the mnemonic on that function.
Mnemonic	The HP-IB mnemonic
S	Syntax type. See "Syntax Types", earlier in this chapter.
?	Interrogate response. If a response is defined, it is listed.
0	OPC-compatible command.
Range	The range of acceptable inputs and corresponding units.

Symbol conventions:

[]	Optional data.
D	Numerical data.
I	An integer appendage that is part of the command. For example, CLEA<I> , where I= 1 to 5, indicates that the actual commands are CLEA1 , CLEA2 , CLEA3 , CLEA4 , and CLEA5 .
\$	A character string operand which must be enclosed by double quotes
< >	A necessary appendage.
	An either/or choice in appendages

Table I-11. Key Select Codes

Function	Action	Mnemonic	S	?	0	Range
AVG						
Averaging	Restart	AVERREST	1			
	Factor	AVERFACT[D]	3	D		0 to 999
	On/off	AVERO<ON OFF>	2	1,0		
smoothing	Set aperture	SMOOAPER[D]	3	D		0.06 to 20%
	On/off	SMOOO<ON OFF>	2	1,0		
IF bandwidth	Set bandwidth	IFBW[D]	3	D		10, 30, 100, 300, 1000, 3000, 3700 Hz
CAL-error correction, calibration						
Correction	On/off	CORR<ON OFF>	2	1,0		
Interpolative correction	On/off	CORI<ON OFF>	2	1,0		
Resume Cal sequence	Resume a previously started calibration	RESC	1			
Receiver calibration	Set power level for receiver calibration	REIC[D]	3			stimulus power range
	Take receiver calibration sweep	TAKRS				
Port extensions	Port 1	PORT1[D]	3	D		±10 s
	Port 2	PORT2[D]	3	D		±10 s
	Input A	PORTA[D]	3	D		±10 s
	Input B	PORTB[D]	3	D		±10 s
	Off	PORE<ON OFF>	2	1,0		
Velocity factor	Set value	VELOFACT[D]	3	D		0 to 10
4	Set Value	SETZ[D]	3	D		0.1 to 500Ω
Adapterremoval	Recall Cal Port1	CALSPORT1	1			
	Recall Cal Port2	CALSPORT2	1			
	Adapter delay	ADAP1[D]	3	D		±10 s
	Adapter: coax	ADPTCOAX	1			
	Adapter: waveguide	ADPTWAVE	1			
	Remove adapter	MODS	1			
Test set switching	Continuous/full 2-port cal (continuously measures all 4 S-parameters)	CSWION	2	1,0		
	Hold 2-port cal (initially measure all 4 S-parameters, then only 2 parameters)	TSSWION CSWIOFF	2	1,0		
		TSSWIOFF				
	Number of sweeps 2-port cal	TSSWI[D]	3	D		

Table 1-10. Key Select Codes (continued)

Function	Action	Mnemonic	S	?	0	Range
CAL-error correction, calibration (continued)						
Sweep modes	Alternate A and B	ALTAB	1			
	Chop A and B	CHOPAB	1			
Calibrate menu	None	CALN	1	0,1		
	Response	CALIRESP	1	0,1		
	Response and Isol	CALIRAI	1	0,1		
	S11 1-port	CALIS111	1	0,1		
	S22 1-port	CALIS221	1	0,1		
	Full z-port	CALIFUL2	1	0,1		
	One path 2-port	CALIONE2	1	0,1		
	TRL/LRM 2-port	CALITRL2	1	0,1		
Intermediate cal steps, 1 path/2-port	Isolation	ISOOP	1			
	Reflection	REFOP	1			
	Transmission	TRAOP	1			
Intermediate cal steps, full z-port Cal	Transmission	TRAN	1			
	Reflection	REFL	1			
	Isolation	ISOL	1			
Intermediate cal steps, TRL/LRM	Transmission	TRLT	1			
	S ₁₁ Reflection	TRLR1	1			
	S ₂₂ Reflection	TRLR2	1			
	Line/match 1	TRLL1	1			
	Line/match 2	TRLL2	1			
Select response & isol. class	Response	RAIRESP	1			
	Isolation	RAISOL	1			
Select reflection class	S11A (forward open)	CLASS11A	1			»PCT†
	S11B (forward short)	CLASS11B	1			»PCT†
	S11C (forward load)	CLASS11C	1			»PCT†
	S22A (reverse open)	CLASS22A	1			»PCT†
	S22B (reverse short)	CLASS22B	1			»PCT†
	S22C (reverse load)	CLASS22C	1			»PCT†
Select transmission class	Forward transmission	FWDT	1			»PCT†
	Reverse transmission	REVT	1			»PCT†
	Forward match	FWDM	1			»PCT†
	Reverse match	REVM	1			»PCT†
Select isolation class	Forward isolation	FWDI	1			»PCT†
	Reverse isolation	REVI	1			»PCT†
	Omit isolation	OMII	1			

† The class commands are OPC-compatible if there is only one standard in the class. If there is just one standard, that standard is measured automatically. If there is more than one standard in the class, the class command only calls another menu.

Table 1-10. Key Select Codes (continued)

Function	Action	Mnemonic	S	?	0	Range
CAL-error correction, calibration (continued)						
Select standard in class	Standard A	STANA	1			OPC
	Standard B	STANB	1			OPC
	Standard C	STANC	1			OPC
	Standard D	STAND	1			OPC
	Standard E	STANE	1			OPC
	Standard F	STANF	1			OPC
	Standard G	STANG	1			OPC
Sliding load	Set	SLIS	1			OPC
	Done	SLID	1			
Offset load	Load no offset	LOAN	1			
	Load offset	LOAO	1			
Done with:	Class	DONE	1			
	Isolation	ISOD	1			OPC
	Reflection	REFD	1			OPC
	Transmission	TRAD	1			OPC
	Offset load	OFLD	1			
Save cal	Response	RESPDNE	1			OPC
	Resp and isol	RAID	1			OPC
	1-port cal	SAV1	1			OPC
	a-port cal	SAV2	1			OPC
	TRL/LRM	SAVT	1			OPC
CAL-calibration kits						
Select default kits	7-mm	CALK7MM	1	1,0		
	3.5-mmC	CALK35MC*	1	1,0		
	3.5-mmD	CALK35MD	1	1,0		
	Type N, 50 ohm	CALKN50	1	1,0		
	Type N, 76 ohm	CALKN75	1	1,0		
	2.4-mm	CALK24MM	1	1,0		
	2.92-mm	CALK292MM	1	1,0		
	2.92*	CALK292S	1	1,0		
	User-defined	CALKUSED	1	1,0		
	TRL 3.5-mm	CALKTRLK	1	1,0		
Modify kit	Modify current	MODI1	1			
Define std. number (begin std. definition)		DEFS[D]	3			1 to 8
<p>CALK35MM selects the HP 85033C cal kit for the HP 8752C/53D, and selects the HP 86062 series cal kits for the HP 8719D/20D/22D.</p>						

Table 1-10. Key Select Codes (continued)

Function	Action	Mnemonic	S	?	0	Range
CAL-calibration kits (continued)						
Define std. type	Open	STDTOPEN	1	1,0		
	Short	STDTSHOR	1	1,0		
	Load	STDTLOAD	1	1,0		
	Delay/thru	STDTDELA	1	1,0		
	Arbitrary imped.	STDTARBI	1	1,0		
Define std. parameters	Open cap. C0	C0[D]	3			$\pm 10\text{k} (10^{-15} \text{ F})$
	Open cap. C1	C1[D]	3			$\pm 10\text{k} (10^{-27} \text{ F/Hz})$
	Open cap. C2	C2[D]	3			$\pm 10\text{k} (10^{-36} \text{ F/Hz}^2)$
	Open cap. C3	C3[D]	3			$\pm 10\text{k} (10^{-45} \text{ F/Hz}^3)$
	Fixed load	FIXE	1			
	Sliding load	SLIL	1			
	Offset load	OFLS	1			
	Terminal imped.	TERI[D]	3			0 to 1 k Ω
Define std. offsets	Delay	OFSD[D]	3			$\pm 1 \text{ s}$
	Loss	OFSL[D]	3			0 to 1000 T Ω /s
	Z0	OFSZ[D]	3			0.1 to 500 Ω
	Min. frequency	MINF[D]	3			0 to 1000 GHz
	Max. frequency	MAXF[D]	3			0 to 1000 GHz
	Coaxial	COAX	1	0,1		
	Waveguide	WAVE	1	0,1		
Std. done	Standard defined	STDD	1			
Label std.		LABS[\$]	3			LO char.
Specify class	Response	\$PECRESP[I,I..]	3			\$td numbers
	Resp & Isol	\$PECRESI[I,I..]	3			\$td numbers
	S11A (forward open)	\$PECS11A[I,I..]	3			\$td numbers
	S11B (forward short)	\$PECS11B[I,I..]	3			\$td numbers
	S11C (forward load)	\$PECS11C[I,I..]	3			\$td numbers
	S22A (reverse open)	\$PECS22A[I,I..]	3			\$td numbers
	S22B (reverse short)	\$PECS22B[I,I..]	3			\$td numbers
	S22C (reverse load)	\$PECS22C[I,I..]	3			\$td numbers
	Forward Trans	\$PECFWDT[I,I..]	3			\$td numbers
	Forward Match	\$PECFWDM[I,I..]	3			\$td numbers
	Reverse Trans	\$PECREVT[I,I..]	3			\$td numbers
	Reverse Match	\$PECREVM[I,I..]	3			\$td numbers
	TRL Thru	\$PECTRLT[I,I..]	3			\$td numbers
	TRL Reflect	\$PECTRLR[I,I..]	3			\$td numbers
	TRL Line or Match	\$PECTRLI[I,I..]	3			\$td numbers

Table 1-10. Key Select Codes (continued)

Function	Action	Mnemonic	s	?	0	Range
CAL-calibration kits (continued)						
Class done		CLAD	1			
Label class	Response	LABERESP[\$]	3			10 char.
	Resp. & isolation	LABERESI[\$]	3			10 char.
	S11A	LABES11A[\$]	3			10 char.
	S11B	LABES11B[\$]	3			10 char.
	S11C	LABES11C[\$]	3			10 char.
	S22A	LABES22A[\$]	3			10 char.
	S22B	LABES22B[\$]	3			10 char.
	S22C	LABES22C[\$]	3			10 char.
	Forward Trans	LABEFWDT[\$]	3			10 char.
	Forward Match	LABEFWDM[\$]	3			10 char.
	Reverse Trans	LABEREVT[\$]	3			10 char.
	Reverse Match	LABEREVM[\$]	3			10 char.
	TRL Thru	LABETRLT[\$]	3			10 char.
	TRL Reflect	LABETRLR[\$]	3			10 char.
	TRL Liue or Match	LABETRLI[\$]	3			10 char.
Label kit		LABK[\$]	3			10 char.
Kit done		KITD	1			
Save kit	Into user kit	SAVEUSEK	1			
TRL/LRM Option	Cal ZO: Line ZO	CALZLINE	1	0,1		
	Cal ZO: System ZO	CALZSYST[D]	1	0,1		
	SET REF: Thru	SETRTHRU	1	0,1		
	SET REF: Reflect	SETRREFL	1	0,1		

Table 1-10. Key Select Codes (continued)

Function	Action	Mnemonic	S	?	0	Range
CAL-power meter calibration						
Power meter cal	Off	PWMCOFF[D]	3	D		Cal power: -100 to 100 dB
	Each sweep	PWMCEACS[D]	3	D		Cal power: -100 to 100 dB
	One sweep	PWMCONES[D]	3	D		Cal power: -100 to 100 dB
	Take cal sweep [§]	TAKCS	1			
	Number of readings	NUMR[D]	3	D		1 to 100
	Set port cal pwr	PWEMCAL	1	D		-100 to 100 dB
Edit power loss table	On/off	PWRLOSS<ON OFF>	2	1,0		
	Edit list	POWLLIST	1			
	Use sensor A or B	USES<ENSA ENSB>	2			Sensor B available with HP 438A only
	Add segment	SADD	1			
	Edit segment N	SEDI[D]	3	D		1 to 12
	Done with segment	SDON	1			
	Delete segment	SDEL	1			
	Done	EDITDONE	1			
	Clear list	CLEL	1			
Edit power loss segment	Frequency	POWLFREQ[D]	3	D		Stimulus range [†]
	Value	POWLLOSS[D]	3	D		-9900 to 9900 dB
Edit cal sensor table	Edit sensor menu A	CALFSENA	1			
	Edit sensor menu B	CALFSENB	1			HP 438A only
	Add segment	SADD	1			
	Edit segment N	SEDI[D]	3	D		1 to 12
	Done with segment	SDON	1			
	Delete segment	SDEL	1			
	Done	EDITDONE	1			
	Clear list	CLEL	1			
Edit cal sensor segment	Frequency	CALFFREQ[D]	3	D		Stimulus range [†]
	Cal factor	CALFCALF[D]	3	D		1 to 200%
<p>For frequency or power sweeps, refer to Chapter 12, "Preset State and Memory Allocation," in the <i>HP 8719D/20D/22D User's Guide</i>.</p> <p>Requires pass control mode when using the BP-IB port.</p>						

Table 1-10. Key Select Codes (continued)

Function	Action	Mnemonic	s	?	0	Range
CHANNEL						
Channel	CH 1 active	CHAN1	1		OPC	
	CH 2 active	CHAN2	1		OPC	
	CH 3 active	CHAN3	1		OPC	
	CH 4 active	CHAN4	1		OPC	
COPY						
Copy display	To printer [§]	PRINALL	1			10 char.
	To plotter [§]	PLOT	1			
Title plot	To disk	TITP[\$]	4			
Printer	Auto feed	PRNTRAUTF<ON OFF>	2	1,o		
Printer	Form feed	PRNTRFORF	1			
Printer setup	Default	DEFPRINT	1			
Plotter	Auto feed	PLTTRAUTF<ON OFF>	2	1,o		
Plotter	Form feed	PLTTRFORF	1			
Plotter setup	Default	DFLT	1			
List values		LISV	1			
Operating parameters		OPEP	1			
Next page		NEXP	1			
Previous page		PREP	1			
Print List values or Operating parameters	Raster display dump to HP-IB [§]	PRINTALL	1			
Restore display		RESD	1			
Select print color	Monochrome	PRIS	1			
	Color	PRIC	1			
<p>Requires pass control mode when using the HP-IB port. These commands are not queriable, but the channel active status may be found by using OUTPCHAN which returns 1, 2, 3, or 4.</p>						

Table 1-10. Key Select Codes (continued)

Function	Action	Mnemonic	S	?	0	Range
COPY (continued)						
Print feature color	Data channel 1	PCOLDATA1<color>	2			Colors [†]
	Data channel 2	PCOLDATA2<color>	2			Colors [†]
	Data channel 3	PCOLDATA3<color>	2			Colors [†]
	Data channel 4	PCOLDATA4<color>	2			Colors [†]
	Memory channel 1	PCOLMEMO1<color>	2			Colors [†]
	Memory channel 2	PCOLMEMO2<color>	2			Colors [†]
	Memory channel 3	PCOLMEMO3<color>	2			Colors [†]
	Memory channel 4	PCOLMEMO4<color>	2			Colors [†]
	Graticule	PCOLGRAT<color>	2			Colors [†]
	Reference line	PCOLREFL<color>	2			Colors [†]
	Text	PCOLTEXT<color>	2			Colors [†]
	Warning	PCOLWARN<color>	2			Colors [†]
	Features to be Plotted	Data	PDATA<ON OFF>	2	1,0	
Memory		PMEM<ON OFF>	2	1,0		
Graticule		PGRAT<ON OFF>	2	1,0		
Text		PTEXT<ON OFF>	2	1,0		
Marker		PMKR<ON OFF>	2	1,0		
Quadrant	Left lower	LEFL	1	0,1		
	Left upper	LEFU	1	0,1		
	Right lower	RIGL	1	0,1		
	Right upper	RIGU	1	0,1		
	Full page	FULP	1	0,1		
Pen number	Data	PENNDATA[D]	3			0,1,2 ... 10
	Memory	PENNMEMO[D]	3			0,1,2 ... 10
	Graticule	PENNGRAT[D]	3			0,1,2 ... 10
	Text	PENNTEXT[D]	3			0,1,2 ... 10
	Marker	PENNMAR[D]	3			0,1,2 ... 10
Line type	Data	LINTDATA[D]	3			0,1,2 ... 10
	Memory	LINTMEMO[D]	3			0,1,2 ... 10
Plot scale	Full page	SCAPFULL	1			
	Graticule to p1,p2	SCAPGRAT	1			
Plot speed	Slow	PLOSSLOW	1			
	Fast	PLOFAST	1			
Colors = white cyan magenta blue yellow green red black						

Table 1-10. Key Select Codes (continued)

Function	Action	Mnemonic	S	?	0	Range
DISPLAY						
Channels	Auxiliary on/off	AUXC<ON OFF>	2	1,0	OPC	
	Dual on/off	DUAC<ON OFF>	2	1,0		
	split on/off	SPLD<ON OFF>	2	1,0		
	One-graticule display	SPLID<1>	1	1,0		
	Two-graticule display	SPLID<2>	1	1,0		
	Four-graticule display	SPLID<4>	1	1,0		
	Two-graticule display with channel 2 on top	D2XUPCH2	1			
	Two-graticule display with channel 3 on top	D2XUPCH3	1			
	Four-graticule display with channel 2 in upper right	D4XUPCH2	1			
	Four-graticule display with channel 3 in upper right	D4XUPCH3	1			
	D2/D1 to D2 (Channel 2 data divided by channel 1 data, and displayed on channel 2)	D1DIVD2<ON OFF>	2	1,0		
	Display	Data	DISPDATA	1),1	
Memory only		DISPMEMO	1),1		
Data and mem		DISPDATM	1),1		
Data/mem		DISPDDM	1),1		
		DIVI				
Data — mem		DISPDMM	1),1		
		MINU				
Data to mem		DATI	1),1	OPC	
Intensity		[NTE[D]	3)		50 to 100
Blank Display		BLAD<ON OFF>	2	1,0		
Title		ITTL[\$]	4)		18 char.
beeper	On done	BEEPDONE<ON OFF>	2	1,0		
	On warning message	BEEPWARN<ON OFF>	2	1,0		
frequency notation	Blank	FREO	1			
adjust display	Background intensity	BACI[D]	3)		1 to 100
	Save colors	SVCO	1			
	Recall colors	RECO	1			
	Default colors	DEFC	1			

Table 1-10. Key Select Codes (continued)

Function	Action	Mnemonic	s	?	0	Range
DISPLAY(Continued)						
Modify specific display feature colors	Ch 1 data/lim ln	COLOCH1D	1			
	Ch 1 memory	COLOCH1M	1			
	Ch 2 data/lim ln	COLOCH2D	1			
	Ch 2 memory	COLOCH2M	1			
	Ch 3 data/lim ln	COLOCH3D	1			
	Ch 3 memory	COLOCH3M	1			
	Ch 4 data/lim ln	COLOCH4D	1			
	Ch 4 memory	COLOCH4M	1			
	Graticule	COLOGRAT	1			
	Reference line	COLOLREF	1			
	Text	COLOTEXT	1			
	Warning	COLOWARN	1			
Adjust specific display feature color	Brightness	CBRI[D]	3	D		0 to 100
	Color	COLOR[D]	3	D		0 to 100
	Tint	TINT[D]	3	D		0 to 100
	Reset color to default	RSCO	1			

Table 1-10. Key Select Codes (continued)

Function	Action	Mnemonic	s	?	0	Range
ENTRY						
Step keys	UP	UP	1			
	Down	DOWN	1			
Entry off		ENTO	1			
FORMAT						
Format	Log mag	LOGM	1	0,1		
	Phase	PHAS	1	0,1		
	Delay	DELA	1	0,1		
	Smith chart	SMIC	1	0,1		
	Polar	POLA	1	0,1		
	Lin mag	LINM	1	0,1		
	Real	REAL	1	0,1		
	Imaginary	IMAG	1	0,1		
	SWR	SWR	1	0,1		
LOCAL						
HP-IB modes	Talker/listener	TALKLIST	1	0,1		
	Use pass control	USEPASC	1	0,1		
Debug	Display commands	DEBU<ON OFF>	2	1,0		
Disk drive	unit	DISCUNIT[D]	3	D		0 to 30
	Volume	DISCVOLU[D]	3	D		0 to 30
HP-IB addresses	Plotter	ADDRPLOT[D]	3	D		0 to 30
	Printer	ADDRPRIN[D]	3	D		0 to 30
	Disk drive	ADDRDISC[D]	3	D		0 to 30
	Controller	ADDRCONT[D] PCB[D]	3	D		0 to 30
Power meter	Address	ADDRPOWM[D]	3			0 to 30
	Type	POWM<ON OFF>	2	0,1		On = 436A, Off = 438A/437B
Select plotter type	Plotter	PLTTYPLTR	1			
	HPGL printer	PLTTYHPGL	1			
Select printer type	ThinkJet	PRNTYPTJ	1			
	DeskJet	PRNTYPDJ	1			
	LaserJet	PRNTYPLJ	1			
	PaintJet	PRNTYPPJ	1			
	Epson-P2	PRNTYPEP	1			
	DJ 540	PRNTYP540	1			

Table 1-10. Key Select Codes (continued)

Function	Action	Mnemonic	S	?	0	Range
LOCAL (continued)						
Select printer port	HP-IB	PRNPRTHPIB	1			
	Parallel	PRNPRTPARA	1			
	serial	PRNPRTSERI	1			
Select plotter port	HP-IB	PLTPRTHPIB	1			
	Parallel	PLTPRTPARA	1			
	serial	PLTPRTSERI	1			
	Disk	PLTPRTDISK	1			
Printer serial port	Baud rate	PRNTRBAUD[D]	3	D		1200, 2400, 4800, 9600, 19200
Printer serial port	Handshake	PRNHNSHK<XON DTR>	2	1, 0		
Plotter serial port	Baud rate	PLTTRBAUD[D]	3	D		1200, 2400, 4800, 9600, 19200
Plotter serial port	Handshake	PLTHNSHK<XON DTR>	2	1, 0		
Parallel port	Configure	PARAL<GPIO CPY>	2	0,1		GPIO = Gen.Purpose I/O, CPY = COPY use
MEAS						
Input ports	AIR	AR	1	0,1		
	B/R	BR	1	0,1		
	A/B	AB	1	0,1		
	A	MEASA	1	0,1		
	B	MEASB	1	0,1		
	R	MEASR	1	0,1		
	Selects testport 1 or 2	TSTP<P1 P2>	2			
	Analog input	ANAI[D]	1*	0,1		
S-Parameters	S11	S11	1	0,1		
		RFLP				
	S12	S12	1	0,1		
	S21	S21	1	0,1		
		TRAP				
Conversion to alternate parameters	S22	S22	1	0,1		
	off	CONVOFF	1	0,1		
	Z:reflection	CONVZREF	1	0,1		
	Z:transmission	CONVZTRA	1	0,1		
	Y:reflection	CONVYREF	1	0,1		
	Y:transmission	CONVYTRA	1	0,1		
	1/S	CONV1DS	1	0,1		
<p>Syntax type 1 when ANABOFF. Syntax type 3, and range = 1 to 31, when ANABON. Refer to the <i>HP 8719D/20D/22D Network Analyzer Service Guide</i> for information on the analog bus.</p>						

Table 1-10. Key Select Codes (continued)

Function	Action	Mnemonic	S	?	0	Range	
MENU (stimulus)							
Power	Level	POWE[D]	3	D		-85 to +20 dBm	
	Trip	POWT<ON OFF>	2	1,0			
	Always couple power	COUP<ON OFF>	2	1,0			
	Port power coupling	PORTP<CPLD UNCPLD>	2				
	Range 0		POWR00	2			
			PRAN01	2			
	Range 1		POWR01	2			
			PRAN02	2			
	Range 2		POWR02	2			
			PRAN03	2			
	Range 3		POWR03	2			
			PRAN04	2			
	Range 4		POWR04	2			
			PRAN05	2			
	Range 5		POWR05	2			
			PRAN06	2			
	Range 6		POWR06	2			
			PRAN07	2			
	Range 7		POWR07	2			
			PRAN08	2			
	Range 8		POWR08	2			
			PRANOQ	2			
	Range 9		POWROQ	2			
		PRAN10	2				
Range 10		POWR10	2				
		PRAN011	2				
Range 11		POWR11	2				
		PRAN12	2				
	Power range auto/manual	PWRR<PAUTO PMAN>	2				
	Source power on/off	SOUP<ON OFF>	2				
	Attenuator A (Option 086)	ATTA[D]	3		0to55dB		
	Attenuator B (Option 086)	ATTB[D]	3		0to55dB		
Time	Specify	SWET[D]	3)		0.01 to86,400 s	
	Selects fastest sweep time	SWEA	1				
Measurement	Restart	REST	1				

Table 1-10. Key Select Codes (continued)

Function	Action	Mnemonic	S	?	0	Range
MENU (stimulus) (continued)						
Trigger	Hold	HOLD	1	0,1		
		TRIG				
	Single	SING	1		OPC	
	Number of groups	NUMG[D]	3		OPC	1 to 999
	Continuous	CONT	1	0,1		
		FRER				
	External trigger off	EXTTOFF	2	0,1	OPC	
	External trigger on sweep	EXTTON	2	0,1	OPC	
	External trigger on point	EXTTPOIN	1	0,1	OPC	
Manual trigger on point	MANTRIG	1	0,1	OPC		
Points	Specify	POIN[D]	3	D		3, 11, 26, 51, 101 201,401, 801, 1601
Coupled channels	On/off	COUC<ON OFF>	2	1,0		
CW freq	Set value	CWFREQ[D]	3	D		Stimulus range [†]
Sweep type	Linear	LINFREQ	1	0,1		
	Log	LOGFREQ	1	0,1		
	List	LISFREQ	1	0,1		
	Select a segment	SSEG[D]	3	0,1		1 to 30
	Select all segments	ASEG	1	0,1		
	Power	POWS	1	0,1		
	CW time	CWTIME	1	0,1		
	Step	STEPSWP<ON OFF>	2	0,1		
Edit list	Begin	EDITLIST	1			
	Add segment	SADD	1			
	Edit segment N	SEDI[D]	3	D		1 to 30
	Delete segment	SDEL	1			
	Done	EDITDONE	1			
	Clear list	CLEL	1			
<p>For frequency or power sweeps, refer to Chapter 12, "Preset State and Memory Allocation," in the <i>HP 8719D/20D/22D User's Guide</i>. For CW time: 0 to 24 hours. For frequency sweep, transform on: $\pm 1/\text{frequency}$ step. For CW time sweep, transform on: $\pm 1/\text{time step}$.</p>						

Table 1-10. Key Select Codes (continued)

Function	Action	Mnemonic	s	?	0	Range
MENU (stimulus) (continued)						
Edit segment	start	STAR[D]	3	D		Stimulus range [†]
	Stop	STOP[D]	3	D		Stimulus range [†]
	Center	CENT[D]	3	D		Stimulus range [†]
	Span	SPAN[D]	3	D		Stimulus range [†]
	Points	POIN[D]	3	D		1 to 1632
	Stepsize	STPSIZE[D]	3	D		Stimulus range [†]
	c w	CWFREQ[D]	3	D		Stimulus range [†]
	Done with segment	SDON	1			
Single/All segment	Single segment sweep	SSEG[D]	1			
	All segment sweep	ASEG	1	0,1		
MARKER						
Select active	1 to 5	MARK<I>[D]	3	D		Stimulus range [†]
	All off	MARKOFF	1	0,1		
Barker zero	zero offsets	MARKZERO	1			
Delta reference	1 to 5	DELR<I>	2	0,1		1 to 5
	Fixed marker	DELRFIXM	1	0,1		
	Mode off	DELO	1	0,1		
Fixed mkr position	Stimulus	MARKFSTI[D]	3	D		Stimulus range [†]
	Value	MARKFVAL[D]	3	D		Amplitude range [#]
	Aux value	MARKFAUV[D]	3	D		Amplitude range [#]
MARKER FCTN						
Marker placement	Discrete	MARKDISC	1	0,1		
	Continuous	MARKCONT	1	0,1		
Coupled	Couple channels	MARKCOUP	1	0,1		
	Uncouple	MARKUNCO	1	0,1		
Displayed	On/off	DISM<ON OFF>	2	1,0		
Polar markers	Log	POLMLOG	1	0,1		
	Linear	POLMLIN	1	0,1		
	Re/Im	POLMRI	1	0,1		
<p>For frequency or power sweeps, refer to Chapter 12, "Preset State and Memory Allocation," in the <i>HP 8719D/20D/22D User's Guide</i>. For CW time: 0 to 24 hours. For frequency sweep, transform on: $\pm 1/\text{frequency}$ step. For CW time sweep, transform on: $\pm 1/\text{time}$ step.</p> <p>[†] For log mag: ± 500 dB. For phase: ± 500 degrees. For Smith chart and Polar: ± 500 units. For linear magnitude: ± 500 units. For SWR: ± 500 units. The scale is always positive, end has minimum values of .001 dB, .0e-12 degrees, 10e-15 seconds, and 10 picounits.</p>						

Table 1-10. Key Select Codes (continued)

Function	Action	Mnemonic	s	?	0	Range
MARKER FCTN (continued)						
Smith markers	Linear	SMIMLIN	1	0,1		
	Log	SMIMLOG	1	0,1		
	Re/Im	SMIMRI	1	0,1		
	R+jX	SMIMRX	1	0,1		
	G+jB	SMIMGB	1	0,1		
Statistics	On/off	MEASSTAT<ON OFF>	2	1,0		
Set function to marker value	start	MARKSTAR	1			
	Stop	MARKSTOP	1			
	Center	MARKCENT	1			
	Span	MARKSPAN	1			
	Reference	MARKREF	1			
	Delay	MARKDELA	1			
Search	Off	SEAOFF	1	0,1		
	Maximum	SEAMAX	1	0,1		
		MARKMAXI				
	Minimum	SEAMIN	1	0,1		
		MARKMINI				
	Target	SEATARG[D]	3	D		Amplitude range#
Search left	SEAL	1				
Search right	SEAR	1				
Width	Value	WIDV[D]	3	D		Amplitude range#
	Width on/off	WIDT<ON OFF>	2	1,0		
Tracking search	On/off	TRACK<ON OFF>	2	1,0		
‡ For log mag: ± 500 dB. For phase: ± 500 degrees. For Smith chart and Polar: ± 500 units. For linear magnitude: ± 500 units. For SWR: ± 500 units.						

Table 1-10. Key Select Codes (continued)

Function	Action	Mnemonic	s	?	0	Range
SAVE/RECALL-internal registers						
Save	Selected reg	SAVE<I>	2		OPC	1 to 5
	Selected reg	SAVEREG<I>	2		OPC	01 to 31
Clear	Selected reg	CLEA<I>	2		OPC	1 to 5
	Selected reg	CLEARREG<I>	2		OPC	01 to 31
	All regs	CLEARALL	1		OPC	
Recall	Selected reg	RECA<I>	2		OPC	1 to 5
	Selected reg	RECARREG<I>	2		OPC	01 to 31
Title	Internal reg	TITR<I>[\$]	4			1 to 5, 10 char.
	Internal reg	TITREG<I>[\$]	4			01 to 31, 10 char.
	Save state file	TITF0<I>[\$]	4			01 to 31, 10 char.
	Plot	TITP[\$]	4			01 to 31, 10 char.
SAVE/RECALL-disk files						
Purge	Selected file [§]	PURG<I>	2			1 to 5
Store	lb disk [§]	STOR<I>	2			1 to 5
Title	Disk file	TITF<I>[\$]	4			1 to 5, 10 char.
	Copy labels from file titles	COPYFRFT	1			
	Copy labels from register titles	COPYFRRT	1			
Include with disk files	Data (error corrected, real and imaginary pairs)*	EXTMDATA<ON OFF>	2	l,o		
	Raw data	EXTMRAW<ON OFF>	2	l,o		
	Formatted data	EXTMFORM<ON OFF>	2	l,o		
	User graphics	EXTMGRAP<ON OFF>	2	l,o		
	Data only (error corrected, real and imaginary pairs)*	EXTMDATO<ON OFF>	2	l,o		
Save format	Binary	SAVUBINA	1			
	ASCII/CITIFile	SAVUASCI	1			
Load	From disk [§]	LOAD<I>	2			1 to 5
	Recall file titles [§]	REFT	1			
[§] Requires pass control mode when using the HP-IB port. *See Figure 1-1. This error corrected data is the same as that output by the command OUTPDATA.						

Table 1-10. Key Select Codes (continued)

Function	Action	Mnemonic	s	?	0	Range	
SAVE/RECALL-disk files (continued)							
Initialize	Internal disk	INID	1			256 to 8192	
	External disk	INIE	1				
	LIF Directory size	DIRS[D]	3	D			
Select storage	Internal memory	INTM	1				
	Internal disk	INTD	1				
	External disk	EXTD	1				
	Internal disk	INTD	1				
Disk format	DOS	FORMATDOS	1				
	LIF	FORMATLIF	1				
SCALE REF							
Scale	Auto	AUTO	1			Amplitude range#	
	Value	SCAL[D]	3	D			
Reference	Position	REFP[D]	3	D			
	Value	REFV[D]	3	D			
	Set to mkr	MARKREF	1				
Delay	Set delay	ELED[D]	3	D			
	Coaxial delay	COAD	1				
	Waveguide delay	WAVD	1				
Phase	Offset	PHAO[D]	3	D			360 deg
SEQ-sequencing							
Sequencing menu	Continue sequence	CONS	1			1 to 6	
	Do sequence	DOSEQ<I>	2				
	Gosub sequence	GOSUB<I>	2				
	New/modify sequence	NEWSE<I>	2				
	Pause to select seq.	IPTOS	1				
	Done modify	IDONM	1				
	Select sequence	SEQ<I>	2	I			
		Q<I>					
	Duplicate seq. X to seq. Y	DUPLSEQ<X>SEQ<Y>	2				X, Y = 1 to 6
	Print sequence I	PRINSEQ<I>	2				1 to 6
	Begin title sequence	TITSEQ	1				
	Title sequence I	TITSEQ<I>[\$]	2				1 to 6, 10 char.
	Clear sequence I	CLEASEQ<I>	2				1 to 6
<p># For log mag: ± 500 dB. For phase: ± 500 degrees. For Smith chart and Polar: ± 500 units. For linear magnitude: ± 500 units. For SWR: ± 500 units. The scale is always positive, and has minimum values of .001 dB, .0e-12 degrees, 10e-15 seconds, and 10 picounits.</p>							

Table 1-10. Key Select Codes (continued)

Function	Action	Mnemonic	S	?	0	Range
SEQ-sequencing (continued)						
TTL I/O	TTL out high continuously	TTLOH	1			
	TTL out low continuously	TTLOL	1			
	TTL low - end sweep high	TTLHPULS	1			
	TTL high - end sweep low	TTLFPULS	1			
	Testset I/O forward	TSTIOFWD	1			
	Testset I/O reverse	TSTIOREV	1			
	Programs all GPIO output bits	PARAOUT[D]	3			0 to 255
	Set specified bit on GPIO	SETBIT[D]	2			0 to 7
	Clear specified bit on GPIO	CLEABIT[D]	2			0 to 7
	Specify input GPIO bit for IFBI	PARAIN[D]	2			0 to 4
	Input GPIO bit high - do SEQ<I>	IFBIHIGH	1			
	Input GPIO bit low - do SEQ<I>	IFBILOW	1			
	Save/recall sequences	Store sequence I to disk [§]	STORSEQ<I>	2		
Recall sequence I from disk [§]		LOADSEQ<I>	2			1 to 6
Special functions	Peripheral address	ADDRPERI[D]	3	D		
	Title to peripheral	TITTPERI	1			
	Wait D seconds	SEQWAIT[D]	3	D		0.1 to 3000 s
	Pause	PAUS	1			
	Marker to CW freq.	MARKCW	1			
	Emit beep	EMIB	1			
	Title to HP-IB printer	TITTPRIN	1			
	Title to pwr mtr/HP-IB	TITTPMTR	1			
	Show menus	SHOM	1			
	Assert seq. status bit	ASSS	1			
	Read pwr mtr/HP-IB into title string	PMTRTIT	1			
	Send number into trace memory	TITTMEM	1			
Decisionmaking	If limit test pass then do sequence I	IFLTPASSESEQ<I>	2			1 to 6
	If limit test fail then do sequence I	IFLTFALSESEQ<I>	2			1 to 6
loop counter	Set value	LOOC[D]	3			0 to 32,760
	Increment by 1	INCRLOOC				
	Decrement by 1	DECRLOOC				
	If counter equals 0 then do sequence	IFLCEQZESEQ<I>	2			1 to 6
	If counter not equal to 0 then do sequence	IFLCNEZESEQ<I>	2			1 to 6
Requires pass control when using the HP-IB port.						

Table 1-10. Key Select Codes (continued)

Function	Action	Mnemonic	s	?	0	Range
STIMULUS						
stimulus	Center	CENT[D]	3	D		Stimulus range [†]
	Span	SPAN[D]	3	D		Stimulus range [†]
	start	STAR[D]	3	D		Stimulus range [†]
	Stop	STOP[D]	3	D		Stimulus range [†]
SYSTEM						
Set clock	Time stamp	TIMESTAM<ON OFF>	2	1,o		
	set date	SETDATE[\$]	3			DD MMM YYYY
	Set time	SETTIME[\$]	3			HH:MM:SS
Configure	Sampler, attenuator offsets	RAWOFFS<ON OFF>	2	1,o		
	Retrace power	RETP<ON OFF>	2			
	Step sweep	STEPSPW<ON OFF>	2			
Instrument mode	Network analyzer	INSMNETA	1	0,1	OPC	
	Tuned receiver	INSMTUNR	1	0,1	OPC	
	External R channel	EXTRCHAN	1			
Service	Analog bus	ANAB<ON OFF>	2	1,o		
Frequency offset	On/off	FREQOFFS<ON OFF>	2	1,o	OPC	
	Value	VOFF[D]	3			frequency range of instrument
		LOFREQ[D]	3			
	Set RF > LO	RFGTLO	1			
	Set RF < LO	RFLTLO	1			
	Select up converter	UCONV	1			
	Select down converter	DCONV	1			
	View measurement/mixer setup	VIEM<ON OFF>	2	1,o		
[†] For frequency or power sweeps, refer to Chapter 12, "Preset State and Memory Allocation," in the <i>HP 8719D/20D/22D User's Guide</i> . For CW time: 0 to 24 hours. For frequency sweep, transform on: $\pm 1/\text{frequency}$ step. For CW time sweep, transform on: $\pm 1/\text{time}$ step.						

Table 1-10. Key Select Codes (continued)

Function	Action	Mnemonic	S	?	0	Range
SYS EM-limit testing						
Limit line	On/off	LIMILINE<ON OFF>	2	1,0		
Limit test	On/off	LIMITEST<ON OFF>	2	1,0		
	Beeper	BEEPFIL<ON OFF>	2	1,0		
Limit offset	Stimulus	LIMISTIO[D]	3	D		Stimulus range [†]
	Amplitude	LIMIAMPO[D]	3	D		Amplitude range [#]
	Marker to offset	LIMIMAOF	1			
Edit table	Begin edit	EDITLIML	1			
	Add segment	SADD	1			
	Edit segment D	SEDI[D]	3	D		1 to 18
	Delete segment	SDEL	1			
	Done with edit	EDITDONE	1			
	Clear list	CLEAL	1			
Edit segment	Stimulus value	LIMS[D]	3	D		Stimulus range [†]
	Marker to stimulus	MARKSTIM	1			
	Upper limit	LIMU[D]	3	D		Amplitude range [#]
	Lower limit	LIML[D]	3	D		Amplitude range [#]
	Delta limits	LIMD[D]	3	D		Amplitude range [#]
	Middle value	LIMM[D]	3	D		Amplitude range [#]
	Marker to middle	MARKMIDD	1			
	Segment done	SDON	1			
Limit type	Flat line type	LIMTFL	1	0,1		
	Sloping line type	LIMTSL	1	0,1		
	Single point type	LIMTSP	1	0,1		

[†] For frequency or power sweeps, refer to Chapter 12, "Preset State and Memory Allocation," in the *HP 8719D/20D/22D User's Guide* For CW time: 0 to 24 hours. For frequency sweep, transform on: $\pm 1/\text{frequency}$ tip. For CW time sweep, transform on: $\pm 1/\text{time step}$.

[#] For log mag: ± 500 dB. For phase: ± 500 degrees. For Smith chart and Polar: ± 500 units. For linear magnitude: ± 500 units. For SWR: ± 500 units. The scale is always positive, and has minimum values of .001 dB, $10e-12$ degrees, $10e-15$ seconds, and 10 picounits.

Table 1-10. Key Select Codes (continued)

Function	Action	Mnemonic	S	?	0	Range
SYSTEM-transform						
Transform	Time Domain Transform On/off	TIMDTRAN<ON OFF>	2	0,1		
Set freq	Low pass	SETF	1			
Mode	Low pass impulse	LOWPIMPU	1	0,1		
	Low pass step	LOWPSTEP	1	0,1		
	Bandpass	BANDPASS	1	0,1		
	Specify gate menu	SPEG	1			
Window	Maximum	WINDMAXI	1			
	Normal	WINDNORM	1			
	Minimum	WINDMINI	1			
	Any value	WINDOW[D]	3	D		tate dependent
Window shape	Use trace memory	WINDUSEM<ON OFF>	2	1,0		
Demodulation	Off	DEMOOFF	1	0,1		
	Amplitude	DEMOAMPL	1	0,1		
	Phase	DEMOPHAS	1	0,1		
Gate	On/off	GATEO<ON OFF>	2	1,0	OPC	
	Start	GATESTAR[D]	3	D		timulus range†
	Stop	GATESTOP[D]	3	D		timulus range†
	Center	GATECENT[D]	3	D		timulus range†
	Span	GATESPAN[D]	3	D		timulus range†
Gate shape	Maximum	GATSMAXI	1	0,1		
	Wide	GATSWIDE	1	0,1		
	Normal	GATSNORM	1	0,1		
	Minimum	GATSMINI	1	31	I	
† For frequency or power sweeps, refer to Chapter 12, "Preset State and Memory Allocation," in the <i>HP 8719D/20D/22D User's Guide</i> . For CW time: 0 to 24 hours. For frequency sweep, transform on: $\pm 1/\text{frequency step}$. For CW time sweep, transform on: $\pm 1/\text{time step}$.						

HP-IB Only Commands

Table 1-12. HP-IB Only Commands

Action	Mnemonic	Syntax	?	Description
MISCELLANEOUS				
Identify instrument	IDN?	1		Outputs the identification string: "HEWLETT PACKARD, 87NND,0,X.XX", where 87NND is the model number of the instrument and X.XX is the firmware revision of the instrument.
Key	KEY [D]	1	D	Imitates pressing a key. The data transmitted is the key code, as defined in Figure 1-6. Range for D=1 to 61.
Key code	KOR?	1		Outputs last key code or knob count. If the reply is positive, it is a key code. If it is negative, then set bit 16 equal to bit 14, and the resulting two byte integer is the RPG knob count. It can be either positive or negative. There are about 120 counts per turn.
Move marker	MARKBUCK[D]	2	D	Moves the marker to the selected point on the trace. On a 201 point sweep, D can range from 0 to 200.
On completion	OPC	1		Causes reporting of the last OPC-compatible command completion.
Plot/print softkeys	PSOFT<ON OFF>	2		Includes the softkey menu keys when printing or plotting the screen.
Copy default	DEFLTCPIO	1		Sets up a default state for copy.
Revision	SOFR	1		Displays the software revision on the analyzer.
Learn string	SELL[D]	2	D	Selects the learn string revision to input to and output from the analyzer. The valid parameters are: 0: Defaults to current revision. 201: Revision 8720A 2.01 612: Revision 8720A 6.12

Table 1-11. HP-IB Only Commands(continued)

Action	Mnemonic	syntax ?		Description
MISCELLANEOUS (continued)				
Sweep start	SWPSTART	1		Initiates a sweep and immediately releases the HP-IB bus, allowing the analyzer to initiate data output as soon as the appropriate data is ready. Use in conjunction with Take4 mode only. OPC-compatible.
Collect raw data	TAKE4<ON OFF>	2	1,0	Initiates a mode in which every measurement cycle is characterized by sweeping in both the forward and reverse directions and collecting raw data for all four S-parameters. The sweeping can occur when a SWPSTART or SING command is received or when the analyzer is in continuous, number of groups, or external trigger mode.
Self test	TST?	1		Causes a self test. Returns a zero if the test passes.
No operation	NOOP	1		Creates a cycle that has no operation. OPC compatible.
Select 1-port cal	CAL1	1		Provides access to functions within the 1-port cal menu. (HP 8610 compatibility.)
External trigger	EXTTHIGH	1		Sets the trigger polarity high.
	EXTTLOW	1		Sets the trigger polarity low.
Wait	WAIT	1		Makes the analyzer wait for a clean sweep when used with the OPC command.
INIT				
Error-corrected data	INPUDATA[D]	3	D	Inputs error-corrected data.
Formatted Data	INPUFORM[D]	3	D	Inputs formatted data.
Raw Data	INPURAW1[D]	3	D	Inputs raw data.
	INPURAW2[D]	3	D	
	INPURAW3[D]	3	D	
	INPURAW4[D]	3	D	
Error coefficient	INPUCALC<01, 02, ... 12>	2		Inputs an individual error coefficient array. Issue the command "CALIXXXX;"(XXXX specifies the data calibration type), then input each of the appropriate individual error coefficients using "INPUCALC". Finally, issue "SAVC;" and trigger a sweep.
	SAVC	1		This OPC compatible command denotes completion of the error coefficients transfer to the instrument.
Power meter cal.	INPUPMCAL<I>	3		Inputs power meter cal array. Values should be entered as 100 times the power meter reading in dB.
Cal kit	INPUCALK[D]	3	D	Inputs a cal kit.
Learn string	INPULEAS[D]	3	D	Inputs the learn string. Preceded by SELL if learn string is not current revision.

Table 1-11. HP-IB Only Commands (continued)

Action	Mnemonic	syntax	?	Description
OUTPUT				
Active function	OUTPACTI	1		Outputs value of function in active entry area in ASCII format.
Active channel	OUTPCHAN	1		Outputs the active channel number.
Options	OUTPOPTS	1		Outputs an ASCII string of the options installed.
Serial number	OUTPSERN	1		Outputs the serial number of the analyzer.
Identify instrument	OUTPIDEN	1		See IDN?
Error coefficient	OUTPCALC<01,02 . . . 12>	2		Outputs the selected error coefficient array from the active channel. Each array is the same as a data array. See Table 1-9, for the contents of the arrays.
Interp. cal.	OUTPICAL<I>	2		Outputs the selected interpolated cal coefficient array.
Cal kit	OUTPCALK	1		Outputs the active cal kit, a less than 1000 byte string in FORM 1.
Data	OUTPDATA	1		Outputs the error corrected data from the active channel in real/imaginary pairs. See Figure 1-4.
	OUTPDATF	1		Fastdatatransfer command for OUTPDATA.
Error	OUTPERRO	1		Outputs the oldest error in the error queue. The error number is followed by the error message in ASCII format (FORM 4).
Formatted	OUTPFORM	1		Outputs the formatted trace data from the active channel in current display units. See Table 1-4 for data transferred.
	OUTPFORF	1		Fast data transfer command for OUTPFORM. Only the first number of the OUTPFORM data pairs is transferred. See Table 1-4.
Power meter cal.	OUTPIPMCAL<I>	2		Outputs the interpolated power meter cal array for channel 1 or channel 2.
Power meter cal.	OUTPPMCAL<I>	2		Outputs power meter cal array for channel 1 or channel 2. Values are sent as 100 times the power meter reading in dB.
Key code	OUTPKEY	1		Outputs the code of the last key pressed, in ASCII format. See Figure 1-6 for key codes. -1 is transmitter for a knob turn.

Table 1-11. HP-IB Only Commands (continued)

Action	Mnemonic	syntax ?	Description
OUTPUT (continued)			
Learn string	OUTPLEAS	1	Outputs the learn string in binary, not intended for decoding.
External source	OUTPRFFR	1	Outputs external source RF frequency when in external source instrument mode.
smoothing	OUTPAPER	1	Outputs the smoothing aperture.
Sequencing	OUTPSEQ<I>	2	Outputs sequence I (I = 1 to 6) listing over HP-IB.
Limit failures	OUTPLIMF	1	Outputs the limit results as described under OUTPLIML for only those stimulus points that failed.
Limitlist	OUTPLIML	1	Outputs the limit test results for each stimulus point. The results consist of four numbers. The first is the stimulus value tested, the second is the test result: -1 for no test, 0 for fail, 1 for pass. The third number is the upper limit value, and the fourth is the lower limit value. This is an ASCII transfer (FORM 4).
Limit marker	OUTPLIMM	1	Outputs the limit test results as described for OUTPLIML for the active marker.
Marker	OUTPMARK	1	Outputs the active marker values in 3 numbers. The first two numbers are the marker values, and the last is the stimulus value. See Table 1-4 for the marker values
Memory	OUTPMEMO	1	Outputs the memory trace from the active channel. It is error corrected data in real/imaginary pairs, and can be treated the same as data from OUTPDATA.
	OUTPMEMF	1	Fast data transfer command for OUTPMEMO.
Marker statistics	OUTPMSTA	1	Outputs marker statistics: mean, standard deviation, and peak to peak deviation. ASCII format (FORM 4).
Bandwidth	OUTPMWID	1	Outputs results of bandwidth search:bandwidth, center; and Q. ASCII format (FORM 4).
Bandwidth+ loss	OUTPMWIL	1	Same operation as OUTPMWID plus the loss value.
Plot	OUTPPLOT	1	Outputs the HP-GL plot string in ASCII format to the HP-IB port. Can be directed to an HP-GL plotter or printer.

Table 1-11. HP-IB Only Commands (continued)

Action	Mnemonic	Syntax	?	Description
OUTPUT (continued)				
Print	OUTPPRIN	1		Outputs the print string of the display graphics.
	OUTPPRNALL	1		Outputs all pages List Values or current page of Operating and marker parameters in ASCII. Activate the desired function with LISV to print values or OPEF to print operating parameters prior to this command.
Pre-raw data	OUTPPRE1	1		Array 1 (S11 data). Analogous to OUTPRAW except that pre-raw data has not had sampler correction nor attenuator offsets applied. Use in conjunction with Take4 mode only.
	OUTPPRE2	1		Array 2 (S21 data).
	OUTPPRE3	1		Array 3 (S12 data).
	OUTPPRE4	1		Array 4 (S22 data).
Raw data	OUTPRAW1	1		Array 1 (S11 data). Outputs uncorrected data arrays for the active channel. Raw 1 holds the single parameter data unless a 2-port calibration is on, in which case raw 1 holds S11 and the following arrays hold S21, S12, and S22, respectively. The data is in real/imaginary pairs.
	OUTPRAW2	1		Array 2 (S21 data).
	OUTPRAW3	1		Array 3 (S12 data).
	OUTPRAW4	1		Array 4 (S22 data).
	OUTPRAF<I>	1		Fast data transfer command for OUTPRAW<I>.
Status byte	OUTPSTAT STB?	1		Outputs the status byte. ASCII format (FORM 4).
Display title	OUTPTITL	1		Outputs the display title. ASCII format (FORM 4).
Max values	OUTPAMAX*	1		Outputs max values for all limit line segments.
Min values	OUTPAMIN*	1		Outputs min values for all limit line segments.
Min/Max values	OUTPSEGAM*	1		Outputs limit test min/max all segs. Outputs the segment number, max stimulus, max value, min stimulus, min value for all active segments.†
Min/max value	OUTPSEGM*	1		Outputs limit test min/max for a specified segment. See SELSEG[D].†
<p>For the definition of a limit segment, see "Example Display of Limit Lines" in the Chapter 2 section titled "Limit Line and Data Point Special Functions."</p> <p>Refer to the "Limit Line and Data Point Special Functions" section in Chapter 2.</p>				

Table 1-11. HP-IB Only Commands (continued)

Action	Mnemonic	syntax	?	Description
OUTPUT (continued)				
Data: point	OUTPDATP	1		Outputs trace data indexed by point. (see SELPT[D])
Data: range	OUTPDATR	1		Outputs trace data for range of points. (see SELMINPT[D], SELMAXPT[D])
Limit test: ch1	OUTPLIM1*	1		Outputs status [§] of limit test for channel 1.
Limit test: ch2	OUTPLIM2*	1		Outputs status [§] of limit test for channel 2.
Limit test: ch3	OUTPLIM3*	1		Outputs status [§] of limit test for channel 3.
Limit test: ch4	OUTPLIM4*	1		Outputs status [§] of limit test for channel 4.
Limit test status	OUTPSEGAFF*	1		Outputs the segment number and its limit test status [§] for all active segments. [†]
Limit test status	OUTPSEGF*	1		Outputs the limit test status [§] for a specified segment. See SELSEG[D]. [†]
Fail report	OUTPFAIP*	1		This command is similar to OUTPLIMF except that it reports the number of failures first, followed by the stimulus and trace values for each failed point in the test.
Clock	READDATE	1		Outputs the date of the clock in the following format: DDMMYYYY
Clock	READTIME	1		Outputs the time of the clock in the following format: HH:MM:SS
LIMIT LINE AND DATA POINT TEST				
Min/max recording	MINMAX<ON OFF>*	2	1,0	Enables/disables min/max recording per segment. Min and max values are recorded per limit segment.
Segment	SELSEG[D]*	3	D	Selects segment number for the OUTPSEGF and OUTPSEGM commands to report on. D can range from 1 to 18. [†]
Last point	SELMAXPT[D]	3	D	Selects the last point number in the range of points that the OUTPDATR command will report. D can range from 0 to the number of points minus 1.
First point	SELMINPT[D]	3	D	Selects the first point number in the range of points that the OUTPDATR command will report. D can range from 0 to the number of points minus 1.
Specify point	SELPT[D]	3	D	Selects point number that the OUTPDATR command will report. D can range from 0 to the number of points minus 1.
<p>† Refer to the "Limit Line and Data Point Special Functions" section in Chapter 2.</p> <p>Values returned for limit test status are: 1 (PASS), 0 (FAIL), -1 (NO_LIMIT)</p> <p>For the definition of a limit segment, see "Example Display of Limit Lines" in the Chapter 2 section titled "Limit Line and Data Point Special Functions."</p>				

Table 1-11. HP-IB Only Commands (continued)

Action	Mnemonic	syntax	?	Description
OUTPUT FORMATS				
	FORM1	1		HP 8719/20/22 internal format, with header.
	FORM2	1		32 bit floating point, with header (IEEE).
	FORM3	1		64 bit floating point, with header (IEEE).
	FORM4	1		ASCII format. No header.
	FORM5	1		32 bit PC format (bytes reversed).
SOFTKEYS				
Press	SOFT[I]	2		Activates softkey I, I= 1 to 8.
Label	WRSK<I>[\$]	4		Writes label (10 char) to indicated softkey I, where I = 1 to 8. Initial use of this command requires previous commands MENUFORM; and MENUOFF;.
STATUS REPORTING				
Clear	CLES CLS	1		Clears the status byte.
Interrogate	ESB?	1		Returns event-status register B.
	ESR?	1		Returns the event-status register.
	OUTPSTAT	1		Returns the status byte.
Enable	ESE[D]	1	D	Enables event-status register. (0<D<255)
	ESNB[D]	1	D	Enables event-status register B. (0<D<255)
	SRE[D]	1	D	Enables SRQ. (0<D<255)
MENUS				
Averaging	MENUAVG	1		
Calibration	MENUCAL	1		
Copy	MENUCOPY	1		
Display	MENUDISP	1		
Format	MENUFORM	1		
Marker	MENUMARK	1		
Meas	MENUMEAS	1		
Marker function	MENUMRKF	1		
Off	MENU<ON OFF>	2		
Save Recall	MENURECA	1		
Save Recall	MENUSAVE	1		
Scale	MENUSCAL	1		
Stimulus	MENUSTIM	1		
System	MENUSYST	1		
Sequencing	MENUSBQU	1		

Alphabetical Mnemonic Listing

Mnemonic	Description
AB	Measures and displays A/B on the active channel.
ADAP1[D]	Sets adapter electrical delay.
ADDRCONT[D]	Controller HP-IB address: the address where control is returned after a pass control.
ADDRDISC[D]	Disk HP-IB address.
ADDRPERI[D]	Peripheral HP-IB address (for sequencing). See also TITTPERI .
ADDRPLOT[D]	Plotter HP-IB address.
ADDRPOWM[D]	Power meter HP-IB address
ADDRPRIN[D]	Printer HP-IB address
ADPTCOAX	Sets adapter to COAXial .
ADPTWAVE	Sets adapter to WAVEguide .
ALC	ALC control.
ALTAB	Places the analyzer in the alternate inputs measurement mode, where measurements are made on alternate sweeps See also CHOPAB ;.
ANAB<ON OFF>	Enables the analog bus for service use.
ANAI[D]	Measures and displays the data at the auxiliary input (ANALOG IN).
AR	Measures and displays A/R on the active channel.
ASEG	Uses all segments for list frequency sweep. See also SSEG[D] .
ASSS	Asserts the sequence status bit.
ATTA[D]	Attenuator A (Option 085 Only).
ATTB[D]	Attenuator B (Option 085 Only).
AUXC<ON OFF>	Enables and disables the auxiliary channels (3 and 4). OPC-compatible.
AUTO	Auto scale the active channel.
AVERFACT[D]	Sets the averaging factor on the active channel.
AVERO<ON OFF>	Turns averaging ON and off on the active channel.
AVERREST	Restart the averaging on the active channel.
BACI[D]	Sets the background intensity of the display.
BANDPASS	Selects the time domain bandpass mode.
These 3 commands control the warning beeper, causing it to sound if the indicated condition occurs:	
BEEPDONE<ON OFF>	The completion of functions such as save, done with calibration standard, and data trace saved.
BEEPFAIL<ON OFF>	A limit test failure .

BEEPWARN<ON|OFF> The generation of a warning message.

BLAD<ON|OFF> Blanks the display.

BR Measures and displays **B/R** on the active channel.

These commands set the open capacitance values of an open circuit while it is being defined as a calibration standard.

C0[D]

C1[D]

C2[D]

C3[D]

CAL1 Accepted for compatibility with the HP 8510, where its function is to begin a calibration sequence.

These commands set the power meter calibration factor corrections for the particular sensor used. Sensor B is only **valid** for the HP **438A** which has two input channels:

CALFCALF[D] Sets the calibration factor.

CALFFREQ[D] Selects the frequency for the calibration factor correction.

CALFSENA Edits the sensor A calibration factor table.

CALFSENB Edits the sensor B calibration factor table.

These commands begin a calibration sequence:

CALIFUL2 Short, load, open, thru (**SLOT**) 2-port.

CALIONE2 One-path 2-port.

CALIRAI Response and isolation.

CALIRESP Response.

CALIS111 S11 1-port.

CALIS221 S22 1-port.

CALITRL2 Thru, reflect, line or Line, reflect, match (**TRL*/LRM***) 2-port.

These commands select a default calibration kit:

CALK24MM 2.4-mm (HP 85056A/D cal kit).

CALK292MM 2.92-mm.

CALK292S 2.92' (HP 85056K cal kit).

CALK35MD 3.5-mm (HP 85052B/D, HP 85033D cal kit).

CALK35MC 3.5-mm (HP 85033C cal kit).

Note **CALK35MM** selects the HP 85033C cal kit for the HP 8752C/53D, and selects the HP 85052 series cal kits for the HP 8719D/20D/22D.

CALK7MM 7-mm (HP 85031B cal kit and HP 85050 series).

CALKN50 Type-N 50 ohm (HP 85032B/E cal kit).

CALKN75 Type-N 75 ohm (HP 85036B/E cal kit).

CALKTRLK	TRL 3.5-mm (HP 85052C cal kit).
CALKUSED	User-defined calibration kit.
CALN	Calibration: none. Turns calibration type to off.
CALPOW	Provides access to the power meter calibration functions.
CALSPORT1	Recalls cal set associated with Port 1 for adapter removal.
CALSPORT2	Recalls cal set associated with Port 2 for adapter removal.
CALZLINE	Establishes the line or match standard(s) as the characteristic impedance for a TRL/LRM calibration.
CALZSYST[D]	Establishes the system Z_0 (see SETZ) as the characteristic impedance for a TRL/LRM calibration.
CBRI[D]	Adjusts the color brightness of the selected display feature. (See COLOXXX commands)
CENT[D]	Sets the center stimulus value. If a list frequency segment is being edited, sets the center of the list segment.
CHAN1	Makes channel 1 the active channel. OPC-compatible.
CHAN2	Makes channel 2 the active channel. OPC-compatible.
CHAN3	Makes channel 3 the active channel. OPC-compatible.
CHAN4	Makes channel 4 the active channel. OPC-compatible.
CHOPAB	Places the analyzer in the chop measurement mode. See also ALTAB .
CLAD	Class done, modify cal kit , specify class

These commands call reflection standard classes during a calibration sequence. If only one standard is in the class, it is measured. If there is more than one, the standard being used must be selected with **STAN<A|B|C|D|E|F|G>**. If there is only one standard in the class, these commands are OPC-compatible.

CLASS11A	S11A: S11 l-port, opens
CLASS11B	S11B: S11 l-port, shorts
CLASS11C	S11C: S11 l-port, loads
CLASS22A	S22A: S22 l-port, opens
CLASS22B	S22B: S22 l-port, shorts
CLASS22C	S22C: S22 l-port, loads

These commands (all OPC-compatible) clear the indicated save/recall registers:

CLEA1	Clears save/recall register 1.
CLEA2	Clears save/recall register 2.
CLEA3	Clears save/recall register 3.
CLEA4	Clears save/recall register 4.
CLEA5	Clears save/recall register 5.
CLEAL	Clears the limit line list. Should be preceded by EDITLIML .

CLEARALL	Clears all the save/recall registers. OPC-compatible.
CLEABIT[D]	Clears the specified bit on the GPIO.
CLEAREG<I>	Clears save/recall registers 01 through 31. CLEAREG01 through CLEAREG05 are the same as CLEA1 through CLEA5 . OPC-compatible.
These commands clear the sequence from the internal registers:	
CLEASEQ1	Sequence 1.
CLEASEQ2	Sequence 2.
CLEASEQ3	Sequence 3.
CLEASEQ4	Sequence 4.
CLEASEQ5	Sequence 5.
CLEASEQ6	Sequence 6.
CLEL	Clear the currently selected list. This could be a frequency list, power loss list, or limit test list.
CLES	Clears the status register, the event-status registers, and the enable registers.
CLS	Same as CLES.
COAD	Selects coaxial electrical delay. See also WAVD.
COAX	Selects coaxial offsets instead of waveguide while defining a standard during a cal kit modification.
These commands select the indicated display feature for color modification:	
COLOCH1D	Channel 1 data and limit lines.
COLOCH1M	Channel 1 memory.
COLOCH2D	Channel 2 data and limit lines.
COLOCH2M	Channel 2 memory.
COLOCH3D	Channel 3 data and limit lines.
COLOCH3M	Channel 3 memory.
COLOCH4D	Channel 4 data and limit lines
COLOCH4M	Channel 4 memory.
COLOGRAT	Graticule.
COLOLREF	Reference line.
COLOTEXT	Text.
COLOWARN	Warning.
COLOR[D]	Adjusts the color saturation for the selected display feature.
CONS	Continues the paused sequence.

CONT	Continuous sweep trigger mode.
These 6 commands convert the S-parameter data to:	
CONV1DS	Inverted S-parameters.
CONVOFF	Conversion OFF.
CONVYREF	Y:reflection.
CONVYTRA	Y: transmission.
CONVZREF	Z:reflection.
CONVZTRA	Z:transmission.
COPYFRFT	Copies labels from file titles.
COPYFRRT	Copies labels from register titles.
CORI<ON OFF>	Turns interpolative error correction ON and OFF.
CORR<ON OFF>	Turns error correction ON and OFF .
COUC<ON OFF>	Couples and uncouples the stimulus between the channels
COUP<ON OFF>	Couple the power when coupled channels is turned OFF, COUCOFF.
CSWI<ON OFF>	Selects test set continuous switching (ON) or test set hold (OFF) when there is a 2-port calibration active. Continuous switching is allowed only when the power ranges on both attenuator ports are set the same. When continuous switching is ON, the analyzer measures all four S-parameters each time before displaying the data for a full 2-port cal measurement. In test set hold mode, the analyzer measures all four S-parameters once and then measures the desired parameter continuously. This is known as a fast 2-port cal measurement and it is less accurate than a full 2-port calibrated measurement.
CWFREQ[D]	Sets the CW frequency for power sweep and CW frequency modes. While the list frequency table segment is being edited, it sets the center frequency of the current segment.
CWTIME	Selects the CW time sweep type.
D1DIVD2<ON OFF>	This command divides the data in channel 2 by the data in channel 1 and displays the result on channel 2. Dual display must be on (DUACON;).
D2XUPCH2	Positions channels in a 2X display with channel 2 on top.
D2XUPCH3	Positions channels in a 2X display with channel 3 on top.
D4XUPCH2	Positions channels in a 4X display with channel 2 in the upper right.
D4XUPCH3	Positions channels in a 4X display with channel 3 in the upper right.
DATI	Stores trace in channel memory. OPC- compatible.
DCONV	Selects down converter for mixer measurements.
DEBU<ON OFF>	Turns the HP-IB debug mode ON and OFF. When ON, the analyzer scrolls incoming HP-IB commands across the display.

DECRLOOC Decrements the sequencing loop counter by 1.
DEFC Sets the default colors for all display features
DEFLPIUNT Sets the printer to the following default setup conditions:

Print	Monochrome
Auto-feed	on
Print Colors:	
Ch1/Ch3 Data	Magenta
Ch1/Ch3 Memory	Green
Ch2/Ch4 Data	Blue
Ch2/Ch4 Memory	Red
Graticule	Cyan
Warning	Black
Text	Black

DEFLTCPIO Sets up the following default state for copy. There is no equivalent front-panel key.

Plotter Type: PLOTTER	Printer Type: DESKJET
Plotter Port: SERIAL	Printer Port: PARALLEL
Baud Rate: 9600	Baud Rate: 19200
Handshake: Xon-Xoff	Handshake: Xon-Xoff
HP-IB Address: 5	HP-IB Address: 1
Parallel Port: COPY	

DEFS[D] Begins standard definition during **cal** kit modification. D is the standard number.

DELA Displays the data formatted as group delay.

DELO Turns the delta marker mode **OFF**.

These 6 commands make the indicated marker the delta reference:

- DELR1** Marker 1.
- DELR2** Marker 2.
- DELR3** Marker 3.
- DELR4** Marker 4.
- DELR5** Marker 5.
- DELRFIXM** **Fixed** marker.

DEMOAMPL Turns on transform demodulation and sets the transform demodulation to amplitude demodulation. Only has a meaningful effect with a CW time transform.

DEMOOFF Turns the transform demodulation function OFF.

DEMOPHAS Sets the transform demodulation to phase demodulation. Only has a meaningful effect with a CW time transform.

DFLT Sets the plotter to the following default setup conditions

Plot Data On	Pen Number:
Plot Mem On	Data 2
Plot Grat On	Memory 5
Plot Text On	Graticule 1
Plot Mkr On	Text 7
Auto-feed On	Marker 7
Scale Plot Pull	Line Type:
Plot Speed Past	Data 7
	Memory 7

DIRS[D] Sets the number of **files** in the directory at disk initialization. **LIF** only.

DISCUNIT[D] Specifies which disk in an external multiple-disk drive to be used for save/recall.

DISCVOLU[D] **Specifies** which volume of an external multiple-volume disk drive to be used for save/recall.

DISM<ON|OFF> When on, displays the response and sthnulus values for all markers that are turned on; when off, only the active marker's value is displayed.

These 6 commands display the indicated combinations of data and trace memory on the active channel:

DISPDATA Data only.

DISPDATM Data and memory.

DISPDDM Data divided by memory (linear division, log subtraction).

DISPDMM Data minus memory (linear subtraction).

DISPMEMO Memory only.

D M Same as DISPDDM.

DONE Done with a class of standards, during a calibration. Only needed when multiple standards are measured to complete the class

DONM Done modifying a test sequence.

DOSEQ<I> Begins execution of the selected sequence. I = 1 to 6.

DOWN Decrements the value in the active entry area (down key).

DUAC<ON|OFF> **Dual** channel display ON or OFF

DUPLSEQ[X]SEQ[Y] Duplicates sequence X to sequence Y. X,Y = 1 to 6.

EDITDONE	Done editing list frequency or limit table.
EDITLIML	Begins editing limit table.
EDITLIST	Begins editing list frequency table.
ELED[D]	Sets the electrical delay offset.
EMIB	Send out a beep during a sequence.
ENTO	Tums the active entry area OFF .
ESB?	Outputs event-status register B.
ESE[D]	Enables the selected event-status register bits to be summarized by bit 5 in the status byte. An event-status register bit is enabled when the corresponding bit in the operand D is set.
ESNB[D]	Enables the selected event-status register B bits to be summarized by bit 2 of the status byte. A bit is enabled in the register when the corresponding bit in the operand D is set.
ESR?	Outputs the value of the event-status register.
EXTD	Selects the external disk as the active storage device.
These commands include the indicated information when a register is stored on disk. See Figure 1-4 for data types:	
EXTMDATA<ON OFF>	Adds error corrected data (real and imaginary pairs) along with the other files .
EXTMDATO<ON OFF>	Error corrected data array only (real and imaginary pairs).
EXTMFORM<ON OFF>	Formatted trace data. Uses currently selected format for data.
EXTMGRAP<ON OFF>	User graphics
EXTMRAW<ON OFF>	Raw data arrays (real and imaginary pairs).
EXTTHIGH	Sets the external trigger line high.
EXTTLOW	Sets the external trigger line low.
EXTTOFF	Deactivates the external trigger mode. OPC- compatible.
EXTTON	Activates the external trigger mode. OPC- compatible.
EXTTPOIN	Sets the external trigger to auto trigger on point. OPC- compatible.
EXTRCHAN<ON OFF>	Sets the internal phase lock reference selection switch on or off. This allows the analyzer to receive its R channel input through the R CHANNEL IN port or from its own internal source.
FIXE	Specifies a fixed load, as opposed to a sliding load or offset load, when defining a standard during a cal kit modification .

These 5 commands set the data format for array transfers in and out of the instrument:

FORM1	HP 8719D/20D/22D internal format. Preceded by 4 byte header.
FORM2	32 bit floating point format. Preceded by 4 byte header.
FORM3	64 bit floating point format. Preceded by 4 byte header.

FORM4 ASCII format. No header.
FORM5 32 bit floating point PC format. Bytes reversed. Preceded by 4 byte header.

These commands define the format to use on disk initializations:

FORMATDOS Selects DOS as the disk format.
FORMATLIF Selects LIF as the disk format.

FREQOFFS<ON|OFF> Activates the frequency offset instrument mode. OPC-compatible.
FREO Frequency blank. Turns OFF frequency notation.
FRER HP-IB free run. Acts the same as CONT; .
FULP Selects full page plotting, as opposed to plotting in one of the four quadrants

These 3 commands select a forward calibration class, during a **2-port** calibration sequence. They are OPC-compatible if there is only one standard in the class:

FWDI Isolation.
 F W D M Match.
FWDT Transmission.

These 5 commands control the time domain gate:

GATECENT[D] Center time.
GATEO<ON|OFF> Gate ON/OFF, OPC-compatible.
GATESPAN[D] Span time.
GATESTAR[D] Start time.
GATESTOP[D] Stop time.

These 4 commands set the gate shape:

GATSMAXI **Maximum.**
GATSMINI Minimum.
GATSNORM Normal.
GATSWTDE Wide.

GOSUB<I> Invokes a sequence as a subroutine. I = 1 to 6.
 H O L D Puts the sweep trigger into hold.

IDN? Outputs the **identification** string: HEWLETT PACKARD, **87NND**, 0, X.XX, where **87NND** is the model number of the instrument and **X.XX** is the **firmware** revision of the instrument.

These 7 commands branch an executing sequence to a new sequence if the following condition is satisfied.

IFBIHIGH Tests the **specified** input GPIO bit (see **PARAIN [D]**). If high, invokes the sequence which follows

IFBILOW	Tests the specified input GPIO bit (see PARAIN [D]). If low, invokes the sequence which follows.
IFBW[D]	Sets the IF bandwidth.
IFLCEQZESEQ<I>	If loop counter equals zero, then do the sequence that follows
IFLCNEZESEQ<I>	If loop counter does not equal zero, then do the sequence that follows.
IFLTFALSESEQ<I>	If limit test fails, then do sequence that follows.
IFLTPASSESEQ<I>	If limit test passes, then do sequence that follows

IMAG	Selects the imaginary display format.
INCRLOOP	Increments the sequencing loop counter by 1.
INID	Initializes the internal disk. All previous information on the disk will be destroyed.
INIE	Initializes the external disk. All previous information on the disk will be destroyed. Requires pass control when using the HP-IB port.

These commands input **an** individual error coefficient array. Before sending an array, issue a **CALIXXX** ; command, where **XXXX** specifies the calibration type of the data. Then input the array or arrays Lastly store the data with **SAVC ;** . The instrument goes into hold, displaying uncorrected data. Complete the process by triggering a sweep. See **Table 1-9**, for the contents of the different arrays.

INPUCALC01[D]	Array 1.
INPUCALC02[D]	Array 2.
INPUCALC03[D]	Array 3.
INPUCALC04[D]	Array 4.
INPUCALC05[D]	Array 5.
INPUCALC06[D]	Array 6.
INPUCALC07[D]	Array 7.
INPUCALC08[D]	Array 8.
INPUCALC09[D]	Array 9.
INPUCALC10[D]	Array 10.
INPUCALC11[D]	Array 11.
INPUCALC12[D]	Array 12.
INPUCALK[D]	Inputs a cal kit read out with OUTCALK ; . After the transfer, the data should be saved into the user cal kit area with SAVEUSEK ; .
INPUDATA[D]	Inputs an error corrected data array, using the current setting of the FORM command.
INPUFORM[D]	Inputs a formatted data array, using current the current setting of the FORM command.
INPULEAS[D]	Inputs a learn string read out by OUTPLEAS ; .

These commands input power meter calibration arrays into the instrument. Values should be entered as 100 x power meter reading in **dB**.

INPUPMCAL1 Channel 1.

INPUPMCALZ Channel 2.

These commands input a raw data array using the current format. See **OUTPRAW<I>** for the meaning of the arrays. The instrument stops sweeping, error corrects the data, then formats and displays the data.

INPURAW1[D] Array 1.

INPURAW2[D] Array 2.

INPURAW3[D] Array 3.

INPURAW4[D] Array 4.

These commands select the instrument mode. They are **all** OPC-compatible.:

INSMNETA Standard network analyzer. OPC-compatible.

INSMTUNR Tuned receiver. OPC-compatible.

INTD Selects the internal disk as the active storage device.

INTE[D] Sets the display intensity, 50 to 100 percent.

INTM Selects the internal memory for save/recall.

ISOD Done with isolation subsequence in a **2-port** calibration. OPC-compatible.

ISOL Begins the isolation subsequence step in a **2-port** calibration.

ISOOP Selects isolation for one path, two port calibration.

KEY[D] Sends a **keycode**, equivalent to actually pressing the key. It does not matter if the front-panel is in remote mode. See Figure 1-6 for the key codes

KITD Calibration kit done. This is the last step in modifying a cal kit.

KOR? Outputs last key code or knob count. If the reply is positive, it is a key code. If it is negative, then set bit 15 equal to bit 14, and the resulting two byte integer is the RPG knob count. It can be either positive or negative. There are about 120 counts per turn.

These commands enter labels for the standard classes during a **cal** kit modification:

LABEFWDM[\$] Forward match.

LABEFWDT[\$] Forward transmission.

LABERESI[\$] Response, response and isolation.

LABERESP[\$] Response.

LABEREVM[\$] Reverse match.

LABEREVT[\$] Reverse **transmission**.

LABES11A[\$] S11A (opens).

LABES11B[\$] S11B (shorts).

LABES11C[\$] S11C (loads).
LABES22A[\$] S22A (opens).
LABES22B[\$] S22B (shorts).
LABES22C[\$] S22C (loads).
LABETRL[\$] TRL line or match.
LABETRLT[\$] TRL thru.
LABETRLR[\$] TRL reflect.
LABK[\$] Enters a **cal** kit label during a cal kit modification.
LABS[\$] Enters a standard's label during standard definition.

LEFL Selects a plot in the left lower quadrant.
LEFU Selects a plot in the left upper quadrant.
LIMIAMPO[D] Enters the limit line amplitude offset.
LIMILINE<ON|OFF> Turns the display of the limit lines **ON** and **OFF**.
LIMMAOF Marker to limit offset. Centers the limit lines about the current marker position using the limit amplitude offset function.
LIMISTIO[D] Enters the stimulus offset of the limit lines.
LIMITEST<ON|OFF> Turns limit testing **ON** and **OFF**.

These 8 commands edit a limit test segment. The limit table editing is begun with **EDITLIML;**, and a segment is brought up for editing with **SEDI N;** or added using **SADD ;**. The segment is closed with **SDON;**, the table is closed with **EDITDONE;**

LIMD[D] Sets the limit delta value while editing a limit line segment.
LIML[D] Sets the lower limit value.
LIMM[D] Sets the middle limit value.
LIMS[D] Sets the limit stimulus break point.
LIMTFL Makes the segment a flat line.
LIMTSL Makes the segment a sloping line.
LIMTSP Makes the segment a single point.
LIMU[D] Set the upper limit value.

LINFREQ Selects a linear frequency sweep.
LINM Selects the linear magnitude display format.
LINTDATA[D] Enters the line type for plotting data.
LINTMEMO[D] Enters the line type for plotting memory.
LISFREQ Selects the list frequency sweep mode.

LISV Activates the list values function. The next page of values can be called with **NEXP ;** and the previous page can be called with **PREP ;** . The current page can be plotted or printed, in raster graphics mode, with **PLOT;** or **PRINALL ;** respectively. The entire L; ". (Since these commands may need to take control of an HP-IB peripheral, the system controller must have pass control capability.)

These 5 commands load the **file** from disk with the name indicated by the previous **TITF_n** command. The actual **file** loaded depends on the file title in the **file** position specified by the **TITF_n** command. Requires pass control mode.

LOAD1 Loads the **file** from disk using the **file** name provided by the preceding **TITF 1;** command.

LOAD2 Loads the file from disk using the **file** name provided by the preceding **TITF2 ;** command.

LOAD3 Loads the **file** from disk using the **file** name provided by the preceding **TITF3 ;** command.

LOAD4 Loads the **file** from disk using the **file** name provided by the preceding **TITF4;** command.

LOAD5 Loads the **file** from disk using the file name provided by the preceding **TITF5 ;** command.

These 6 commands load the **file** from disk with the name indicated by the previous **TITSEQ_n** command. The actual **file** loaded depends on the **file** title in the **file** position specified in the **TITSEQ_n** command. Requires pass control mode.

LOADSEQ1 Loads sequence 1 from disk.

LOADSEQ2 Loads sequence 2 from disk.

LOADSEQ3 Loads sequence 3 from disk.

LOADSEQ4 Loads sequence 4 from disk.

LOADSEQ5 Loads sequence 5 from disk.

LOADSEQ6 Loads sequence 6 from disk.

LOAN Measures the load as not being offset when a standard has been **defined** as an offset load (see OFLS).

LOAO Measures the load as being offset when a standard has been **defined** as an offset load (see OFLS).

LOFREQ[D] Sets the local oscillator frequency for use in frequency offset mode.

LOGFREQ Selects a log frequency sweep.

LOGM Selects the log magnitude display format.

LOOC[D] Sets the value of the sequencing loop counter.

LOWPIMPU Turns ON the low pass impulse transform.

LOWPSTEP Turns ON the low pass step transform.

LRN? Same as **OUTPLEAS** (output learn string).

LRN[D] Same as **INPULEAS** (input learn string).

MANTRIG Sets the external trigger to manual trigger on point. OPC-compatible.

These commands make the indicated marker active and set its stimulus value:

MARK1[D] Marker 1.

MARK2[D] Marker 2.

MARK3[D] Marker 3.

MARK4[D] Marker 4.

MARK5[D] Marker 5.

MARKBUCK[D] Places the active marker on a specific sweep point (bucket). D is the bucket number, ranging from 0 to number of points less 1.

MARKCENT Sets the center stimulus value to that of the active marker's stimulus value.

MARKCONT Places the markers continuously on the trace, not on discrete points (interpolates the marker values between discrete points).

MARKCOUP Couples the markers between the channels, as opposed to **MARKUNCO**.

MARKCW Sets the CW frequency to the active marker's frequency.

MARKDELA Sets electrical length so group delay is zero at the active marker's stimulus.

MARKDISC Places the markers on the discrete measurement points

MARKFAUV[D] Sets the auxiliary value of the **fixed** marker position. Works in coordination with **MARKFVAL** and **MARKFSTI**.

MARKFSTI[D] Sets the **stimulus** position of the **fixed** marker.

MARKFVAL[D] Sets the value of the fixed marker position.

MARKMAXI Same as **SEAMAX** (search for maximum on current channel's trace).

MARKMIDD During a limit segment edit, makes the marker amplitude the limit segment middle value.

MARKMINI Same as **SEAMIN** (search for minimum on current channel's trace).

MARKOFF Turns all markers and marker functions OFF.

MARKREF Sets the reference value to that of the active marker's amplitude.

MARKSPAN Sets the span for the entire trace to that of the span between the active marker and the delta reference marker.

MARKSTAR Sets the start **stimulus** to that of the active marker's

MARKSTIM During a limit segment edit, sets the limit stimulus break point to that of the active marker's

MARKSTOP Sets the stop **stimulus** to that of the active marker's

MARKUNCO Uncouples the markers between channels, as opposed to **MARKCOUP**.

MARKZERO Places the **fixed** marker at the active marker position and makes it the delta reference.

MAXF[D]	Sets the maximum valid frequency of a standard being defined during a cal kit modification.
MEASA	Measures and displays input A on the active channel.
MEASB	Measures and displays input B on the active channel.
MEASR	Measures and displays input R on the active channel.
MEASTAT<ON OFF>	Turns trace statistics ON and OFF.
MENU<ON OFF>	Blanks the softkey menu. Use with caution, as this may give unusual results when setting up an instrument state. Recommend setting up states using MENU<ON> (default) and, when setup is complete, using MENU<OFF>.

These commands bring up the menu associated with the indicated front-panel key:

MENUAVG	AVG
MENUCAL	CAL
MENUCOPY	COPY
MENUDISP	DISPLAY
MENUFORM	FORMAT
MENUMARK	MARKER
MENUMEAS	MEAS
MENUMRKF	MARKER FCTN
MENURECA	RECALL
MENUSAVE	SAVE
MENUSCAL	SCALE
MENUSEQU	SEQUENCE
MENUSTIM	STIMULUS MENU
MENUSYST	SYSTEM

MINF[D]	Sets the minimum valid frequency of a standard being defined during a cal kit modification.
MINU	Displays data minus memory, the same as DISPDMM.
MINMAX<ON OFF>	Enables/disables min/max recording per segment. Min and max values are recorded per limit segment. Limit testing need not be active.
MODII	Begins the modify cal kit sequence.
MODS	Computes new cal set using adapter removal.
NEWSEQ<I>	Begins modifying a sequence.
NEXP	Displays the next page of the operating parameters list.
NOOP	No operation. OPC-compatible.
NUMG[D]	Activates D number of groups of sweeps. A group is whatever is needed to update the current parameter once. This function restarts averaging if ON. OPC-compatible.

NUMR[D]	Sets the number of power meter readings per point used during a power meter calibration.
OFLD	Offset loads done.
OFLS	Selects the calibration standard load as being an offset load, as opposed to a sliding or fixed load, during a cal kit modification.

These 3 commands specify the offset value for the indicated parameter for a standard being **defined** during a **cal** kit modification:

OFS[D]	Delay offset.
OFSL[D]	Loss offset.
OFSZ[D]	Impedance offset.

OMI	Omits the isolation step of a calibration sequence.
OPC	Operation complete. Reports the completion of the next command received by setting bit 0 in the event-status register, or by replying to an interrogation if OPC? ; is issued.
OPEP	Presents a list of key operating parameters. NEXP ; calls the next page of parameters and the previous page can be called with PREP ; . Requesting a plot or print copies the current page. The current page can be plotted or printed, in raster graphics mode, with PLOT; , or PRINALL ; respectively. The entire list can be printed, in ASCII text mode, with PRINTALL ; . Since these commands need to take control of an HP-IB peripheral, the system controller must have pass control capability.
ORIENT<VERT HOR>	When the auxiliary channels are enabled in 2x or 4x split mode, formats the display so that the auxiliary channels are vertically or horizontally aligned to their primary channels
OUTPACTI	Outputs the value of the active function, or the last active function if the active entry area is OFF.
OUTPAMAX	Outputs the max values for all limit line segments
OUTPAMIN	Outputs the min values for all limit line segments.
OUTPAPER	Outputs the smoothing aperture in stimulus units, rather than as a percentage.

These 12 commands output an error correction array for the active calibration on the active channel. See **Table 1-9**, for the contents of each array. Each array is output in the currently set form determined by the **FORMn** command. The data is in real/imaginary pairs, the same number of pairs as points in the sweep.

OUTPCALC01	Array 1.
OUTPCALC02	Array 2.
OUTPCALC03	Array 3.
OUTPCALC04	Array 4.
OUTPCALC05	Array 5.
OUTPCALC06	Array 6.
OUTPCALC07	Array 7.

OUTPCALC08	Array 8.
OUTPCALC09	Array 9.
OUTPCALC10	Array 10.
OUTPCALC11	Array 11.
OUTPCALC12	Array 12.
OUTPCALK	Outputs the currently active calibration kit, as a less than 1000 byte string. The data is in FORM 1.
OUTPCHAN	Outputs the active channel number, where: <ul style="list-style-type: none"> ■ 1 = channel 1 ■ 2 = channel 2 ■ 3 = channel 3 8 4 = channel 4
OUTPDATA	Outputs the error corrected data from the active channel. See Figure 1-4 and FORMn command.
OUTPDATF	Fast data transfer command for OUTPDATA. =
OUTDATP	Outputs the trace data indexed by point (see SELPT[D]).
OUTDATR	Outputs the trace data for range of points (see SELMINPT[D] , SELMAXPT[D]).
OUTPERRO	Outputs the oldest error message in the error queue. Sends first the error number, and then the error message itself as a string no longer than 50 characters.
OUTPFAJP	This command is similar to OUTPLIMF except that it reports the number of failures first , followed by the stimulus and trace values for each failed point in the test.
OUTPFORM	Outputs the formatted display data array from the active channel. See Table 1-4 for the contents of the array as a function of display format. See also FORMn command.
OUTPFORF	Fast data transfer command for OUTPFORM.

These 12 commands output an interpolated error **coefficient** array for the active calibration on the active channel. See **Table 1-8** for the contents of each array.

OUTPICAL01	Array 1.
OUTPICAL02	Array 2.
OUTPICAL03	Array 3.
OUTPICAL04	Array 4.
OUTPICAL05	Array 5.
OUTPICAL06	Array 6.
OUTPICAL07	Array 7.
OUTPICAL08	Array 8.
OUTPICAL09	Array 9.
OUTPICAL10	Array 10.
OUTPICAL11	Array 11.
OUTPICAL12	Array 12.

OUTPIDEN Outputs the identification string for the analyzer: HEWLETT
PACKARD, **87NND**, 0, **X**. **XX** where **87NND** is the model number of the
instrument and **X.XX** is the **firmware** revision of the instrument.

These 2 commands output the interpolated power meter calibration arrays for channels 1 and 2.

OUTPIPMCL1	Channel 1.
OUTPIPMCL2	Channel 2.

OUTPKEY Outputs the key code of the last key pressed. An invalid key is reported with a 63, a knob turn with a -1. See **Figure 1-6** for the front-panel key codes

OUTPLEAS Outputs the learn string, which contains the entire front panel state, the limit table, and the list frequency table. It is always in binary format not intended for decoding.

OUTPLIM1	Outputs the status of the limit test for channel 1.
OUTPLIM2	Outputs the status of the Limit test for channel 2.
OUTPLIM3	Outputs the status of the Limit test for channel 3.
OUTPLIM4	Outputs the status of the Limit test for channel 4.

These 3 commands output the Limit test results. The results consist of four fields. First is the stimulus **value** for the point. Second is an integer indicating test status. Third is the upper limit at that point. Fourth is the lower limit at that point. If there are no **limits** at that point, the third and fourth fields are zero. The test status is -1 for no test, 0 for fail, and 1 for pass.

OUTPLIMF	Outputs the Limit test results for each failed point.
OUTPLIML	Outputs the Limit test results for each point in the sweep. This is an ASCII transfer.
OUTPLIMM	Outputs the Limit test results at the marker.
OUTPMARK	Outputs the marker values. The first two numbers are the marker response values, and the last is the stimulus value. See Table 1-4 for the meaning of the response values as a function of display format.
OUTPMEMO	Outputs the memory trace from the active channel. The data is in real/imaginary pairs, and can be treated the same as data read with the OUTPDATA command.
OUTPMEMF	Fast data transfer command for OUTPMEMO.
OUTPMSTA	Outputs the marker statistics: mean, standard deviation, and peak-to-peak variation in that order. If statistics is not ON, it is turned ON to generate current values and turned OFF again. See also MEASTAT<ON OFF> .
OUTPMWID	Outputs the marker bandwidths search results: bandwidth, center, and Q in that order. If widths is not ON, it is turned ON to generate current values and turned OFF again.
OUTPMWIL	Performs the same operation as OUTPMWID plus appends the loss value as well .
OUTPOPTS	Outputs an ASCII string of the options installed .
OUTPLOT	Outputs the plot string. Can be directed to a plotter, or read into the computer.

These commands output the power meter calibration array. Values should be entered as 100 times the power meter reading in **dB**. A default array is used if a power meter calibration sweep, **TAKCS**, has not been taken:

OUTPPMCAL1	Channel 1.
OUTPPMCAL2	Channel 2.

These 4 commands output the pre-raw measurement data. See Figure 14 for the meaning of the data. Analogous to OUTPRAW except that pre-raw data has not had sampler correction nor attenuator offsets applied. These offsets are not necessary for data that **will be fully** error corrected. See BASIC programming Example **2E: Take4** — Error Correction Processed on an External Computer. The arrays hold **S11**, **S21**, **S12**, and **S22**, respectively:

OUTPPRE1	Array 1 (S11 data).
OUTPPRE2	Array 2 (S21 data).
OUTPPRE3	Array 3 (S12 data).
OUTPPRE4	Array 4 (S22 data).

OUTPPRIN	Outputs a raster dump of the display, intended for a graphics printer.
OUTPPRNALL	Outputs all of the List Values or Operating parameters in text mode. Activate the desired function by preceding with LISV or OPEP, respectively.
These 5 commands output the raw measurement data. See Figure 14 for the meaning of the data. Normally, array 1 holds the current parameter. If a 2-port calibration is active, the arrays hold S11 , S21 , S12 , and S22 , respectively:	
OUTPRAF<I>	Fast data transfer command for OUTPRAW<I> .
OUTPRAW1	Array 1.
OUTPRAW2	Array 2.
OUTPRAW3	Array 3.
OUTPRAW4	Array 4.
OUTPSEGAF	Outputs the segment number and it's limit test status for all active segments
OUTPSEGAM	Outputs the limit test min/max for all segments Outputs the segment number , max stimulus, max value, min stimulus, min value for all active segments
OUTPSEGF	Outputs the limit test status for a specified segment. See SELSEG[D] .
OUTPSEGM	Outputs limit test min/max for a specified segment. See SELSEG[D].
OUTPSEQ<I>	Outputs I's sequence listing. I = 1 to 6.
OUTPSERN	Outputs the serial number of the analyzer.
OUTFSTAT	Outputs the status byte.
OUTPTTTL	Outputs the display title.
PARAIN[D]	Specify the input GPIO bit to be used by IFBIHIGH and IFBILOW tests.
PARAL<GPIO CPY>	Selects use of the parallel port: for general purpose I/O or for the copy function.
PARAOUT[D]	Programs all GPIO output bits (0 to 255) at once.
PAUS	Inserts a pause into a sequence.
PCB[D]	Same as ADDRCONT. Indicates where control will be returned after a pass control.

These 12 commands select the color for printing the indicated display feature where <COLOR> is one of the following colors: white, cyan, magenta, blue, yellow, green, red, or black.

- PCOLDATA1<COLOR>** Channel 1 data.
- PCOLDATA2<COLOR>** Channel 2 data.
- PCOLDATA3<COLOR>** Channel 3 data.
- PCOLDATA4<COLOR>** Channel 4 data.
- PCOLMEMO1<COLOR>** Channel 1 memory.
- PCOLMEMO2<COLOR>** Channel 2 memory.
- PCOLMEMO3<COLOR>** Channel 3 memory.
- PCOLMEMO4<COLOR>** Channel 4 memory.
- PCOLGRAT<COLOR>** Graticule.
- PCOLREFL<COLOR>** Reference line.
- PCOLTEXT<COLOR>** Displays text.
- PCOLWARN<COLOR>** Warning text.
- PDATA<ON|OFF>** Selects whether trace data is plotted.

These 5 commands select the pen (value for D) for plotting the indicated display feature for the active channel:

- PENNDATA[D]** Data trace.
- PENNGRAT[D]** Graticule.
- PENNMAR[D]** Markers and marker text.
- PENMEMO[D]** Memory trace.
- PENNTXT[D]** **Text** and user graphics
- PGRAT<ON|OFF>** Selects whether the graticule is plotted.
- PHAO[D]** Sets the phase offset.
- PHAS** Selects the phase display format.
- PLOS<SLOW(FAST)>** Selects the pen speed for plotting. (Slow is useful for transparency plotting.)
- PLOT** Initiates a plot.
- PLTHNDSHK<XON|DTR>** Selects the plotter handshake mode as either Xon-Xoff or DTR-DSR.
- PLTPRTDISK** Sets the plotter port to disk (either internal disk or external disk).
- PLTPRTHPIB** Sets the plotter port to HP-IB.
- PLTPRTPARA** Sets the plotter port to parallel.
- PLTPRTSERI** Sets the plotter port to serial.
- PLTTRAUTF<ON|OFF>** Turns ON and OFF the plotter auto feed.
- PLTTRBAUD[D]** Sets the plotter baud rate.
- PLTTRFORF** Sends a form feed to the plotter.
- PLTTYHPGL** Selects HP-GL compatible *printer* as the plotter type.
- PLTTYPLTR** Selects *plotter* as the plotter type.

PMEM<ON OFF>	Selects whether memory is plotted.
PMKR<ON OFF>	Selects whether markers are plotted.
PMTRTTTT	Reads value from power meter or peripheral at the power meter's HP-IB address into title string.
POIN[D]	Sets the number of points in the sweep.
POLA	Selects the polar display format.

These 3 commands select the marker readout format for polar display:

POLMLIN	Linear markers.
POLMLOG	Log markers.
POLMRI	Real/imaginary markers

PORE<ON OFF>	Turn port extensions ON and OFF.
---------------------------	----------------------------------

These 4 commands set the port extension length for the indicated port or input. Ports 1 and 2 refer to the test set ports:

PORT1[D]	Port 1.
PORT2[D]	Port 2.
PORTA[D]	Input A.
PORTB[D]	Input B.

PORTP<CPLD UNCPLD>	Selects either coupled or uncoupled for the port powers for a given channel.
---------------------------------	--

PORTR[D]	Same as PORT1 .
-----------------	------------------------

PORTT[D]	Same as PORT2 .
-----------------	------------------------

POWE[D]	Sets the output power level. See also PWRR<PAUTO/PMAN> .
----------------	---

POWLFREQ[D]	Selects the frequency for which a power loss correction is entered. This must be followed by a POWLLOSS[D] , which sets the value.
--------------------	---

POWLLIST	Begins editing a power loss list for a power meter calibration.
-----------------	---

POWLLOSS[D]	Sets the loss value for a particular frequency, set by POWLFREQ[D] , in the power loss list.
--------------------	---

POWM<ON OFF>	Designates whether the HP 436A (ON) or the HP 437B/438A (OFT) is to be used as the power meter.
---------------------------	---

POWR<I>	Selects power ranges 00 to 11 when in manual power range.
----------------------	---

POWS	Selects power sweep, from the sweep type menu.
-------------	--

POWT<ON OFF>	Trip power (set maximum attenuation) ON or OFF.
---------------------------	--

PRAN<I>	Selects power ranges 01 to 12 when in manual power range.
----------------------	---

PREP	Displays the previous page of the operating parameters list.
-------------	---

PRES	Presets the analyzer to the factory preset state. OPC-compatible.
-------------	---

PRIC	Selects color print (as opposed to monochrome; see also PRIS).
-------------	--

PRINALL	Copies the display, in raster graphics mode, to a printer.
----------------	--

PRINSEQ<I>	Begins printing the sequence selected.
PRINTALL	Prints all list values or operating and marker parameters in ASCII text mode.
PRIS	Selects standard (monochrome) print.
PRNHNDSHK<XON DTR>	Selects the printer handshake mode as either Xon-Xoff or DTR-DSR.
PRNPRTHPIB	Sets the printer port to HP-IB.
PRNPRTPARA	Sets the printer port to parallel.
PRNPRTSERI	Sets the printer port to serial.
PRNTRAUTF<ON OFF>	Turns ON and OFF the printer auto feed.
PRNTRBAUD[D]	Sets the printer baud rate.
PRNTRFORF	Sends a form feed to the printer.
PRNTYP540	Selects the DeskJet 540 or 850C printer as the printer type.
PRNTYPDJ	Selects the DeskJet printer as the printer type.
PRNTYPEP	Selects the Epson ESC/P2 printer control language-compatible printer as the printer type.
PRNTYPLJ	Selects the LaserJet printer as the printer type.
PRNTYPPJ	Selects the PaintJet printer as the printer type.
PRNTYPTJ	Selects the ThinkJet printer as the printer type.
PSOFT<ON OFF>	Controls whether softkeys are included in the hardcopy print or plot.
PTEXT<ON OFF>	Selects whether text is plotted.
PTOS	Pauses the sequence to be followed by selection one of the 6 sequences(SEQ<I>).

These 5 commands purge the indicated **file** from disk. Requires pass control mode when using an external disk drive.

PURG1	File 1.
PURG2	File 2.
PURG3	File 3.
PURG4	File 4.
PURG5	File 5.

These 3 commands select the type of power meter calibration desired. A calibration sweep should be taken (**TAKCS**) after selecting a “**one** sweep” Power meter calibration, to ensure a valid calibration. No calibration sweep is needed for “each sweep” power meter calibrations.

PWMCEACS[D]	Each sweep.
PWMCOFF[D]	Off.
PWMCONES[D]	One sweep.

PWRLOSS<ON OFF>	Selects whether or not to use the power loss table for a power meter calibration.
------------------------------	---

PWRMCAL	Displays the power meter cal menu and sets the drive port cal power.
PWRR<PAUTO PMAN>	Select the power range auto or manual mode.
Q<I>	Same as SEQ<I> .
RAID	Completes the response and isolation cal sequence. OPC-compatible.
RAISOL	Calls the isolation class for the response and isolation calibration.
RAIRESP	Calls the response class for the response and isolation calibration.
RAWOFFS<ON OFF>	Selects whether sampler and attenuator offsets are ON or OFF. By selecting raw offsets OFF , a full two port error correction can be performed without including the effects of the offsets. It also saves substantial time at recalls and during frequency changes. Raw offsets follow the channel coupling. See BASIC programming Example 2E: Take4 – Error Correction Processed on an External Computer.
READDATE	Outputs the date in the following string format: DD MMM YYYY. HP-IB only command.
READTIME	Outputs the time in the following string format: HH:MM:SS . HP-IB only command.
REAL	Selects the real display format.
RECO	Recalls previously saved display colors,
These 6 commands (OPC-compatible) recall the indicated internal register.	
RECA1	Register 1.
RECA2	Register 2.
RECA3	Register 3.
RECA4	Register 4.
RECA5	Register 5.
RECAREG<I>	Recalls save/recall registers 01 through 31. RECAREG01 through RECAREG05 are the same as RECA1 through RECA5 . OPC-compatible.
REFD	Completes the reflection calibration subsequence of a 2-port calibration. OPC-compatible.
REFL	Begins the reflection calibration subsequence of a 2-port calibration.
REFOP	Begins the reflection calibration subsequence for one path, two port calibration.
REFP[D]	Enters the reference position. 0 is the bottom, 10 is the top of the graticule.
REFT	Recalls file titles from disk.
REFV[D]	Enters the reference line value
REIC[D]	Sets the power level reference value for a receiver calibration.

RESC	Resume cal sequence.
RESD	Restores the measurement display after viewing the operating parameters or list values.
RESPDONE	Completes the response calibration sequence. OPC-compatible.
REST	Measurement restart.
RETP<ON OFF>	Switches retrace power on or off.

These commands (OPC-compatible) **call** the reverse calibration classes, during a full **2-port** calibration.

REVI	Isolation.
REVM	Match.
REVT	Transmission.

These 2 commands are used in frequency offset mode (Option 089) measurements.

RFGTLO	Sets RF greater than LO.
RFLTLO	Sets RF less than LO.

RFLP	Sane as Sll;
RIGL	Selects a plot in the lower right quadrant.
RIGU	Selects a plot in the upper right quadrant.
RSCO	Resets display colors to the factory default.
EST	Presets the instrument. OPC-compatible.

These 4 commands select the S-parameter for the active channel:

S11
S12
S21
S22

SADD	During either a list frequency or limit table edit, adds a new segment to the table.
SAV1	Completes the 1-port calibration sequence. OPC-compatible.
SAV2	Completes the 2-port calibration sequence. OPC-compatible.
SAVC	Completes the transfer of error correction coefficients back into the instrument. OPC-compatible.

These 6 commands (OPC-compatible) store the current instrument state in the indicated internal register.

SAVE1	Register 1.
SAVE2	Register 2.
SAVE3	Register 3.
SAVE4	Register 4.

SAVE5	Register 5.
SAVEREG<I>	Saves to save/recall registers 01 through 31. SAVEREG01 through SAVEREG05 are the same as SAVE1 through SAVE5 . OPC-compatible.
SAVT	Completes the TRL/LRM calibration sequence. OPC-compatible. The 2 following commands define the format for saving files to disk.
SAWASCI	Selects ASCII format for saving to disk. Conforms to CITIFile specifications.
SAVUBINA	Selects binary format for saving to disk.
SAVEUSEK	Stores the active calibration kit as the user kit.
SCAL[D]	Sets the trace scale factor.
SCAP<FULL GRAT>	Selects a full plot, or a plot where the graticule is expanded to the plotter's P1 and P2 .
SDEL	During either a list frequency, a limit table edit, or power loss list, deletes the current segment.
SDON	During either a list frequency, a limit table edit, or power loss list, closes a segment after editing.
These 6 commands control the marker searches The marker searches place the active marker according to the indicated search criteria. The search is continuously updated if tracking is ON (see TRACK):	
SEAL	Search left for next occurrence of the target value.
SEAMAX	Search for trace maximum on the current channel.
SEAMIN	Search for trace minimum on the current channel.
SEAOFF	Turns the marker search OFF.
SEAR	Search right for next occurrence of the target value.
SEATARG[D]	Set the search target amplitude.
SEDI[D]	During either a frequency, limit, or power loss table edit, selects segment D for editing.
SELL[D]	Selects the learn string revision (LRN) or OUTPLEAS , INPULEAS to be used by the analyzer. The valid parameters are: 0: Defaults to current revision. 201: Revision 8720A 2.01 612: Revision 8720A 6.12
SELMAXPT[D]	Selects the last point number in the range of points that the OUTPDATR command will report. D can range from 0 to the number of points minus 1.

SELMINPT[D]	Selects the first point number in the range of points that the OUTPDATR command will report. D can range from 0 to the number of points minus 1.
SELPT[D]	Selects the point number that the OUTPDATR command will report. D can range from 0 to the number of points minus 1.
SELSEG[D]	Selects the segment number to report on for the OUTPSEGF and OUTPSEGM commands D can range from 1 to 18.
SEQ<I>	Selects sequence 1 through 6.
SEQWAIT[D]	Tells the instrument to wait D seconds during a sequence.
SETBIT[D]	Sets the specified bit (0 to 7) on the GPIO.
SETDATE[\$]	Sets the date in the following format: DD MMM YYYY, where DD is the day and must be 2 digits, MMM is the month and must be three alpha characters (JAN, FEB, MAR, APR, MAY, JUN, JUL, AUG, SEP, OCT, NOV, DEC), and YYYY is the year and must be 4 digits
SETF	Set frequency for low pass transform, Option 010.
SETRTHRU	Set reference thru.
SETRREFL	Set reference reflect.
SETTIME[\$]	Sets the time in the following format: HH:MM:SS, where I-III is the hour, MM is minutes, SS is seconds, and each must be 2 digits
SETZ[D]	Set the characteristic impedance of the measurement system.
SHOM	Displays the desired softkey menu during a sequence.
SING	Siie sweep. OPC-compatible.
SLID	Sliding load done.
SLIL	Specifies the standard as a sliding load during a standard definition as part of a cal kit modification, as opposed to a fixed or offset load.
SLIS	Sliding load set. OPC-compatible.
SMIC	Select Smith chart display format.
The following commands select the marker readout format on a Smith chart:	
SMIMGB	G + jB (conductance and susceptance).
SMIMLIN	Linear magnitude.
SMIMLOG	Log magnitude.
SMIMRI	Real/imaginary pairs (resistance and reactance).
SMIMRX	R+jX.
SMOOAPER[D]	Sets the smoothing aperture as a percent of the trace.
SMOOO<ON OFF>	Turns smoothing ON and OFF.
SOFR	Displays the firmware revision on the screen.
The following 8 commands act as though the indicated soft key was pressed:	
SOFT1	Softkey 1.
SOFT2	Softkey 2.

SOFT3	Softkey 3.
SOFT4	Softkey 4.
SOFT5	Softkey 5.
SOFT6	Softkey 6.
SOFT7	Softkey 7.
SOFT8	Softkey 8.

SOUP<ON|OFF> Turns the source power ON and OFF.

SPAN[D] Sets the stimulus span. If a list frequency segment is being edited, sets the span of the segment.

The following commands initiate the **SPECIFY CLASS** part of modifying a cal kit. After issuing each command, send the analyzer a series of standard numbers to be included in the class. When the class is full, send CLAD ; to terminate the specification.

SPECFWDM[I] Forward match.

SPECFWDT[I] Forward transmission.

SPECRESP[I] Response.

SPECRESI[I] For Resp & Isol, specifies the response standards.

SPECREVM[I] Reverse match.

SPECREVT[I] Reverse transmission.

SPECS11A[I] S11A.

SPECS11B[I] S11B.

SPECS11C[I] S11C.

SPECS22A[I] S22A.

SPECS22B[I] S22B.

SPECS22C[I] S22C.

SPECTRLL[I] TRL Line or Match.

SPECTRLT[I] TRL Thru.

SPECTRLR[I] TRL Reflect.

SPEG Displays the specify gate menu. See also DUAC.

SPLD<ON|OFF> Turns the split display mode ON and OFF.

SPLID1 Displays all active channels on one graticule.

SPLID2 Displays all active channels on two graticules.

SPLID4 Displays each active channel in a separate graticule.

SRE[D] Service request enable. A bit set in D enables the corresponding bit in the status byte to generate an SRQ.

SSEG[D] Selects the desired segment of the frequency list for a list frequency sweep. See also ASEG.

STB? Outputs the status byte. Same as OUTPSTAT.

The following 7 commands (OPC compatible) select a standard from a class during a calibration sequence. If a class is requested, as in **CLASS11A (S11 l-port cal)** the analyzer will do one of two things. If there is only one standard in the class, it will measure that standard automatically. If there are several standards in the class, then one of the following commands must be used to select one of these standards, causing it to be measured.

STANA	Standard listed under softkey 1 .
STAN-B	Standard listed under softkey 2 .
STANC	Standard listed under softkey 3 .
STAND	Standard listed under softkey 4 .
STANE	Standard listed under softkey 5 .
STANF	Standard listed under softkey 6 .
STANG	Standard listed under softkey 7 .

STAR[D] Enters the start stimulus value. If a list frequency segment is being edited, sets the start of the segment.

STDD Standard done, terminating a **define** standard sequence, while modifying a cal kit.

The following 5 commands select the standard “type” after the standard number has been entered during a modify **cal** kit sequence:

STDTARBI	Arbitrary impedance.
STDTDELA	Delay/thru.
STDTLOAD	Load.
STDTOPEN	Open.
STDTSHOR	Short.

STEPSPW<ON|OFF> Step sweep on or off.

STOP[D] Sets the **stimulus** stop value. If a list frequency segment is being edited, sets the stop of the segment.

These 5 commands store the indicated file on disk. Used with the INTD and EXTD commands to designate the internal or external disk.

STOR1	Stores the current instrument state to disk using the file name provided by the preceding TITF1 ; command.
STOR2	Stores the current instrument state to disk using the file name provided by the preceding TITF2 ; command.
STOR3	Stores the current instrument state to disk using the file name provided by the preceding TITF3 ; command.
STOR4	Stores the current instrument state to disk using the file name provided by the preceding TITF4 ; command.
STOR5	Stores the current instrument state to disk using the file name provided by the preceding TITF5 ; command.

These commands store the instrument state to the indicated sequence to disk. Used with the INTD and EXTD commands to designate the internal or external disk. Requires pass control mode when using the HP-IB port.

STORSEQ1 Sequence 1.
STORSEQ2 Sequence 2.
STORSEQ3 Sequence 3.
STORSEQ4 Sequence 4.
STORSEQ5 Sequence 5.
STORSEQ6 Sequence 6.

STPSIZE[D] While editing a list frequency segment, sets step size.

SVCO Saves display colors

SWEA Automatically selects the fastest sweep time based on the current analyzer settings for number of points, IF bandwidth, sweep mode, averaging condition and frequency span.

SWET[D] Sets the sweep time.

SWPSTART This OPC-compatible command initiates a sweep and immediately releases the HP-IB bus, allowing the analyzer to initiate data output as soon as the appropriate data is ready. See BASIC programming Example 2E: **Take4** — Error Correction Processed on an External Computer.

SWR Selects the SWR display format.

TAKCS Begins a power meter calibration sweep.

TAKE4<ON|OFF> This command initiates a mode in which every measurement cycle is characterized by sweeping in both the forward and reverse directions and collecting raw data for all four S-parameters. The sweeping can occur when a SWPSTART or SING command is received or when the analyzer is in continuous, number of groups, or external trigger mode. See BASIC programming Example 2E: **Take4** — Error Correction Processed on an External Computer.

TAKRS Take receiver calibration sweep.

TALKLIST Puts the analyzer in talker listener mode.

TERI[D] **Specifies** the terminal impedance of an arbitrary impedance standard during a cal kit **modification**.

TESS? Query **testset**. Returns a one on the standard analyzer. This command is compatible with the HP 8753D.

TIMDTRAN<ON|OFF> Turns the time domain transform ON and **OFF**. (Option 010).

TIMESTAM<ON|OFF> Turns on the clock time for prints and plots

TITF0<I>[\$] Titles the SAVE STATE filename, only in sequence mode.

TINT[D] Adjusts the tint for the selected display feature.

These commands title the indicated **file** numbers:

TITF1[\$]	File 1.
TITF2[\$]	File 2.
TITF3[\$]	File 3.
TITF4[\$]	File 4.
TITF5[\$]	File 5.
TITL[\$]	Enters a new display title. A maximum of 50 characters are allowed.
TITP[\$]	Titles the plot to disk file.
These commands title the indicated internal register:	
TITR1[\$]	Register 1.
TITR2[\$]	Register 2.
TITR3[\$]	Register 3.
TITR4[\$]	Register 4.
TITR5[\$]	Register 5.
TITREG<I>[\$]	Titles save/recall registers 01 through 31. TITREG01 through TITREG05 are the same as TITR1 through TITR5 .
TITSEQ<I>[\$]	Selects the sequence to be titled. I = 1 to 6.
TITSQ	Provides access to the sequence title functions.
TITMEM	Sends the title string to trace memory.
TITPMTR	Sends the title string to the power meter's HP-IB address
TITPERI	Sends the title string to the peripheral address
TITPRIN	Sends the title string to the printer's HP-IB address
TRACK<ON OFF>	Turns marker search tracking ON and OFF
TRAD	Completes the transmission calibration subsequence of a 2-port calibration. OPC-compatible.
TRAN	Begins the transmission calibration subsequence of a 2-port calibration.
TRAOP	Begins the transmission calibration subsequence for one path, two port calibration.
TRAP	Same as S21 .
TRIG	HP-IB trigger.
TRLL1	Measures TRL Line/match for Port 1 during a TRL/LRM 2-port calibration.
TRLL2	Measures TRL Line/match for Port 2 during a TRL/LRM 2-port calibration.
TRLR1	Measures TRL S11 reflect during a TRL/LRM 2-port calibration.
TRLR2	Measures TRL S22 reflect during a TRL/LRM 2-port calibration.
TRLT	Measures TRL thru during a TRL/LRM 2-port calibration.

TSSWI<ON/OFF>	Same as CSWI.
TST?	Causes a self test and returns a zero if the test is passed.
TSTIOFWD[D]	Defines 3 bits, D0 through D2, on the test set connector I/O for the channel 1 and channel 2 forward settings. These bits can be set to values of 0 through 7.
TSTIOREV[D]	Defines 3 bits, D0 through D2, on the test set connector I/O for the channel 1 and channel 2 reverse settings. These bits can be set to values of 0 through 7.
TSTP<P1 P2>	Selects test port 1 or 2 for non-S-parameter measurements
These commands set the TTL output and end of sweep pulse:	
TTLHPULS	TTL normally low, high pulse at end of sweep.
TTLLPULS	TTL normally high, low pulse at end of sweep.
TTLOH	Sets TTL continuously high.
TTLOL	Sets TTL continuously low.
UCONV	Selects up converter for mixer measurements
UP	Increments the value in the active entry area (up key).
USEPASC	Puts the analyzer in pass control mode.
These commands select the sensor input being used with the HP 438A power meter. For the HP 436A or 437B , the A sensor is always used:	
USESENSA	Sensor A.
USESENSB	Sensor B.
VELOFACT[D]	Enters the velocity factor of the transmission medium.
VIEM<ON OFF>	Displays the measurement trace (ON) or the mixer setup (OFT).
VOFF[D]	Sets the local oscillator frequency for use in frequency offset mode. See also LOFREQ[D].
WAIT	Waits for a clean sweep when used with the OPC command.
WAVD	Selects waveguide electrical delay. (See also COAD.)
WAVE	Specifies a waveguide standard while defining a standard as part of a cal kit modification, as opposed to coaxial.
WIDT<ON OFF>	Turns the bandwidth search ON and OFF.
WIDV[D]	Enters the widths search parameter.
These 5 commands set the window for the transform (Option 010, time domain):	
WINDMAXI	Maximum.
WINDMINI	Minimum.
WINDNORM	Normal.

TSSWI<ON/OFF>	Same as CSWI.
TST?	Causes a self test and returns a zero if the test is passed.
TSTIOFWD[D]	Defines 3 bits, D0 through D2, on the test set connector I/O for the channel 1 and channel 2 forward settings. These bits can be set to values of 0 through 7.
TSTIOREV[D]	Defines 3 bits, D0 through D2, on the test set connector I/O for the channel 1 and channel 2 reverse settings. These bits can be set to values of 0 through 7.
TSTP<P1 P2>	Selects test port 1 or 2 for non-S-parameter measurements.
These commands set the TTL output and end of sweep pulse:	
TTLHPULS	TTL normally low, high pulse at end of sweep.
TTLLPULS	TTL normally high, low pulse at end of sweep.
TTLOH	Sets TTL continuously high.
TTLOL	Sets TTL continuously low.
UCONV	Selects up converter for mixer measurements.
UP	Increments the value in the active entry area (up key).
USEPASC	Puts the analyzer in pass control mode.
These commands select the sensor input being used with the HP 438A power meter. For the HP 436A or 437B , the A sensor is always used:	
USESENSA	Sensor A.
USESENSB	Sensor B.
VELOFACT[D]	Enters the velocity factor of the transmission medium.
VIEM<ON OFF>	Displays the measurement trace (ON) or the mixer setup (OFF).
VOFF[D]	Sets the local oscillator frequency for use in frequency offset mode. See also LOFREQ[D] .
WAIT	Waits for a clean sweep when used with the OPC command.
WAVD	Selects waveguide electrical delay. (See also COAD .)
WAVE	Specifies a waveguide standard while defining a standard as part of a cal kit modification, as opposed to coaxial.
WIDT<ON OFF>	Turns the bandwidth search ON and OFF.
WIDV[D]	Enters the widths search parameter.
These 5 commands set the window for the transform (Option 010, time domain):	
WINDMAXI	Maximum.
WINDMINI	Minimum.
WINDNORM	Normal.

WINDOW[D] Enters arbitrary window.

WINDUSEM<ON|OFF> Turns the trace memory ON as the window shape.

These 8 commands enter new **softkey** labels into the indicated **softkey** positions. Initial use of these commands requires previous commands **MENUFORM ;** and **MENUOFF ;** .

WRSK1[\$] Softkey 1.

WRSK2[\$] Softkey 2.

WRSK3[\$] Softkey 3.

WRSK4[\$] Softkey 4.

WRSK5[\$] Softkey 5.

WRSK6[\$] Softkey 6.

WRSK7[\$] Softkey 7.

WRSK8[\$] Softkey 8.

HP BASIC Programming Examples

Introduction

This is an introduction to the remote operation of the HP 8719D/20D/22D Network Analyzer using an external controller. It is a **tutorial** introduction using BASIC programming examples to demonstrate the remote operation of the network analyzer. The examples used in this chapter are on the “HP 8719D/20D/22D HP BASIC Programming Examples” disk.

The user should be familiar with the operation of the analyzer before attempting to remotely control the analyzer via the Hewlett-Packard Interface Bus (HP-IB). See the *HP 8719D/20D/22D Network Analyzer User's Guide* for analyzer operating information.

The following computers operating with BASIC 6.2 can be used in these examples:

- HP 9000 Series 200/300
- HP 9000 Series 700 with HP BASIC-UX

This document is not intended to teach BASIC programming or to discuss **HP-IB** theory except at an introductory level.

For more information concerning BASIC, see **Table 2-1** for a list of manuals supporting the **BASIC** revision being used. For more information concerning the Hewlett-Packard Interface Bus, see **Table 2-2**.

Table 2-1. Additional BASIC 6.2 Programming Information

Description	HP Part Number
HP BASIC 6.2 Programming Guide	98616-90010
HP BASIC 6.2 Language Reference (2 Volumes)	98616-90004
Using HP BASIC for Instrument Control, Volume I	82303-90001
Using HP BASIC for Instrument Control, Volume II	82303-90002

Table 2-2. Additional HP-IB Information

Description	HP Part Number
HP BASIC 6.2 Interface Reference	98616-90013
Tutorial Description of the Hewlett-Packard Interface Bus	5021-1927

An IBM-compatible personal computer with an **HP-IB/GPIB** interface card may also be used as an instrument controller. Hewlett-Packard provides a software package, HP BASIC for Windows, that will execute the HP BASIC examples as described in this chapter. Contact your local Hewlett-Packard sales office for further information on this package.

Required Equipment

ComputerHP 9000 Series
BASIC operating system.....	.BASIC 6.2
HP BASIC Programming Examples disk.....	.08753-10028
HP-IB interconnect cables	HP 10833A/B/C/D
Test device.....	such as a 125 MHzbandpass filter

Note The test device shipped with the instrument is a 10.24 GHz bandpass filter. If you wish to use this device, the frequency ranges of the example programs must be modified accordingly.

Note The computer must have enough memory to store:

- BASIC 6.2 (4 MBytes of memory is required)
- the required binaries

Upon receipt, make copies of the “Programming Examples” disks. Label them “Programming Examples BACKUP”. These disks will act as reserves in the event of loss or damage to the original disks

Optional Equipment

See the “Compatible Peripherals” chapter in the *HP 8719D/20D/22D Network Analyzer User’s Guide* for complete information on the following optional equipment:

50 Ω type-N calibration kit
Test port return cables
Plotter
Printer
Disk drive

System Setup and HP-IB Verification

This section describes how to:

- Connect the test system.
- Set the test system addresses
- Set the network analyzer’s control mode.
- Verify the operation of the system’s interface bus (HP-IB).

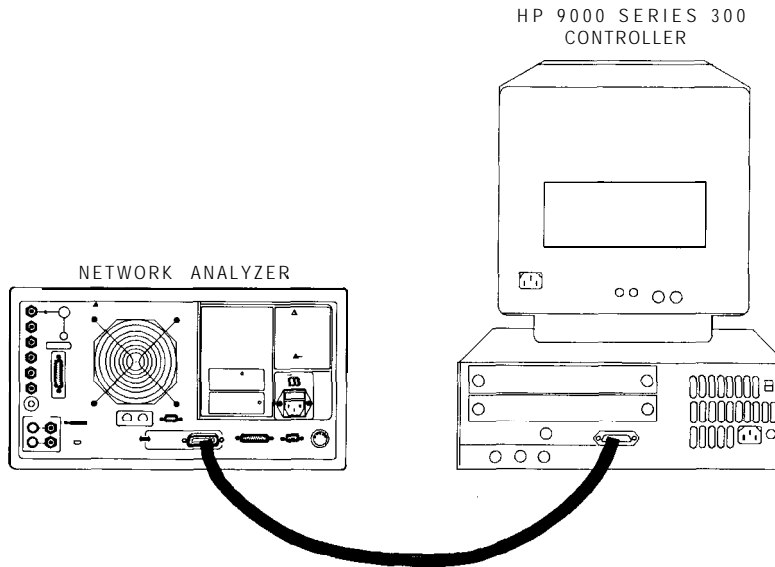

Figure 2-1. The HP 8719D/20D/22D Network Analyzer System with Controller

1. Connect the analyzer to the computer with an HP-IB cable as shown in Figure 2-1.
2. Switch on the computer.
3. Load the BASIC 6.2 operating system.
4. Switch on the analyzer.
 - a. To verify the analyzer's address, press:

Local **SET ADDRESSES** **ADDRESS: 8720**

The analyzer has only one **HP-IB** interface, though it occupies two addresses: one for the instrument and one for the display. The display address is equal to the instrument address with the least-significant bit incremented. The display address is automatically set each time the instrument address is set.

The default analyzer addresses are:

- 16 for the instrument
- 17 for the display

Caution Other devices connected to the bus cannot occupy the same address as the analyzer.

The analyzer displays the instrument's address in the upper right section of the display. If the address is not 16, return the address to its default setting (16) by pressing:

16 **x1** **Preset**

- b. Set the system control mode to either “pass-control” or “talker/listener” mode. These are the only control modes in which the analyzer will accept commands over HP-IB. For more information on control modes, see Chapter 1, “HP-IB Programming and Command Reference.” To set the system-control mode, press:

Local TALKER/LISTENER

or

Local USE PASS CONTROL

5. Check the interface bus by performing a simple command from the computer controller. Type the following command on the controller:

OUTPUT 7 16 ; "PRES ; " **Execute** or **Return**

Note HP 9000 Series 300 computers use the **Return** key as both execute and enter. Some other computers may have an (Enter), **Execute**, or **Exec** key that performs the same function. For reasons of simplicity, the notation **Return** is used throughout this chapter.

This command should preset the analyzer. If an instrument preset does not occur, there is a problem. Check **all** HP-IB addresses and connections. Most HP-IB problems are caused by an incorrect address and faulty/loose HP-IB cables.

HP 8719D/20D/22D Network Analyzer Instrument Control Using BASIC

A remote controller can manipulate the functions of the analyzer by sending commands to the analyzer via the Hewlett-Packard Interface Bus (HP-IB). The commands used are specific to the analyzer. Remote commands executed over the bus take precedence over manual commands executed from the instrument's front panel. Remote commands are executed as soon as they are received by the analyzer. A command only applies to the active channel (except in cases where functions are coupled between channels). Most commands are equivalent to front-panel **hardkeys** and **softkeys**.

Command Structure in BASIC

Consider the **BASIC** command for setting the analyzer's start frequency to 50 MHz:

OUTPUT 716; "STAR 50 MHZ;"

The command structure in BASIC has several different elements:

the BASIC command statement	OUTPUT - The BASIC data-output statement.
the appendage	716 - The data is directed to interface 7 (HP-IB), and on to the device at address 16 (the analyzer). This appendage is terminated with a semicolon. The next appendage is STAR, the instrument mnemonic for setting the analyzer's start frequency.
data	50 - a single operand used by the root mnemonic STAR to set the value.
unit	MHZ - the units that the operand is expressed in.
terminator	; - indicates the end of a command, enters the data, and deactivates the active-entry area.

The "STAR 50 MHZ ;" command performs the same function as pressing the following keys on the analyzer's front panel:

Start **50** **M/u**

STAR is the root mnemonic for the start key, 50 is the data, and MHZ are the **units**. Where possible, the analyzer's root mnemonics are derived from the equivalent key label. **Otherwise** they are derived from the common name for the function. Chapter 1, "HP-IB Programming and Command Reference," **lists** all the root mnemonics and all the different units accepted.

The semicolon (;) **following MHZ** terminates the command within the analyzer. It removes start frequency from the active-entry area, and prepares the analyzer for the next command. If there is a syntax error in a command, the analyzer **will** ignore the command and look for the next terminator. When it finds the next terminator, it starts processing incoming commands normally. Characters between the syntax error and the next terminator are lost. A line feed also acts as a terminator. The BASIC OUTPUT statement transmits a carriage return/line feed following the data. This can be suppressed by putting a semicolon at the end of the statement.

The OUTPUT 716 ; statement will transmit all items listed (as long as they are separated by commas or semicolons) including:

- literal information enclosed in quotes,
- numeric variables,
- string variables,
- and arrays.

A carriage return/line feed is transmitted after each item. Again, this can be suppressed by terminating the commands with a semicolon. The analyzer automatically goes into remote mode when it receives an OUTPUT command from the controller. When this happens, the front-panel remote (R) and listen (L) HP-IB status indicators illuminate. In remote mode, the analyzer ignores any data that is input with the front-panel keys, with the exception of **(Local)**. Pressing **(Local)** returns the analyzer to manual operation, unless the universal HP-IB command LOCAL LOCKOUT 7 has been issued. There are two ways to exit from a local lockout. Either issue the LOCAL 7 command from the controller or cycle the line power on the analyzer.

Setting a parameter such as start frequency is just one form of command the analyzer will accept. It will also accept simple commands that require no operand at all. For example, execute:

```
OUTPUT716;"AUTO;"
```

In response, the analyzer autoscales the active channel. Autoscale only applies to the active channel, unlike start frequency, which applies to both channels as long as the channels are stimulus-coupled.

The analyzer will also accept commands that switch various functions ON and OFF. For example, to switch on dual-channel display, execute:

```
OUTPUT 716;"DUACON;"
```

DUACON is the analyzer root mnemonic for "dual-channel display on". This causes the analyzer to display both channels lb go back to single-channel display mode, for example, switch off dual-channel display, execute:

```
OUTPUT716;"DUACOFF;"
```

The construction of the command starts with the root mnemonic DUAC (dual-channel display) and ON or OFF is appended to the root to form the entire command.

The analyzer does not **distinguish** between upper- and lower-case letters For example, execute:

```
OUTPU716;"auto;"
```

Note

The analyzer also has a debug mode to aid in troubleshooting systems. When the debug mode is ON, the analyzer scrolls incoming HP-IB commands across the display. To manually activate the debug mode, press **(Local)** **HP-IB DIAG ON**. To deactivate the debug mode from the controller, execute:

```
OUTPUT 716;"DEBUOFF;"
```

Command Query

Suppose the operator has changed the power level from the front panel. The computer can find the new power level using the analyzer's command-query function. If a question mark is appended to the root of a command, the analyzer will output the value of that function.

For instance, **POWE 7 DB ;** sets the analyzer's output power to 7 dB, and **POWE? ;** outputs the current RF output power at the test port to the system controller. For example:

Type **SCRATCH** and press **(Return)** to clear old programs

Type **EDIT** and press **(Return)** to access the edit mode.

Then type in:

```
10 OUTPUT 716;"POWE?;"
20 ENTER 716;Reply
30 DISP Reply
40 END
```

Running the Program

The computer will display the preset source-power level in **dBm**. Change the power level by pressing **Local** **Menu** **POWER** **XX** **x1**. Now run the program again.

When the analyzer receives **POWE?**, it prepares to transmit the current RF source-power level. The BASIC statement `ENTER 716` allows the analyzer to transmit information to the computer by addressing the analyzer to talk. This **illuminates** the analyzer front-panel talk (**T**) light. The computer places the data transmitted by the analyzer into the variables listed in the `ENTER` statement. In this case, the analyzer transmits the output power, which gets placed in the variable `Reply`.

The `ENTER` statement takes the stream of binary-data output from the analyzer and reformats it back into numbers and ASCII strings. With the formatting set to its default state, the `ENTER` statement will format the data into real variables, integers, or ASCII strings, depending on the variable being filled. The variable list must match the data the analyzer has to transmit. If there are not enough variables, data is lost. If there are too many variables for the data available, a BASIC error is generated.

The formatting done by the `ENTER` statement can be changed. For more information on data formatting, see Chapter 1, "HP-IB Programming and Command Reference" under the section titled "Array Data Formats". The formatting can be deactivated to allow binary transfers of data. Also, the `ENTER USING` statement can be used to selectively control the formatting.

ON/OFF commands can also be queried. The reply is a one (1) if the function is active, a zero (0) if it is not active. Similarly, if a command controls a function that is underlined on the analyzer **softkey** menu when active, querying that command yields a one (1) if the command is underlined, a zero (0) if it is not. For example, press **Meas**. Though there are seven options on the measurement menu, only one is underlined at a time. The underlined option will return a one (1) when queried.

For instance, rewrite line 10 as:

```
10 OUTPUT 716;"DUAC?;"
```

Run the program once and note the result. Then press **Local** **Display** **DUAL CHAN** **to toggle the display mode, and run the program again.**

Another example is to rewrite line 10 as:

```
10 OUTPUT 716;"PHAS?;"
```

In this case, the program will display a one (1) if phase is currently being displayed. Since the command only applies to the active channel, the response to the `PHAS?` inquiry depends on which channel is active.

Operation Complete

Occasionally, there is a need to query the analyzer as to when certain analyzer operations have completed. For instance, a program should not have the operator connect the next calibration standard while the analyzer is still measuring the current one. To provide such information, the analyzer has an "operation complete" reporting mechanism, or OPC command, that will indicate when certain key commands have completed operation. The mechanism is activated by sending either OPC or OPC? immediately before an OPC-compatible command. When the command completes execution, bit 0 of the event-status register will be set. If OPC was queried with OPC?, the analyzer will also output a one (1) when the command completes execution.

As an example, type SCRATCH and press **Return**.

Type EDIT and press **Return**.

Type in the following program:

```
10 OUTPUT 716;"SWET 3 S;OPC?;SING;" Set the sweep time to 3 seconds, and OPC a  
single sweep.  
20 DISP "SWEEPING"  
30 ENTER716;Reply The program will halt at this point until the  
analyzer completes the sweep and issues a  
one (1).  
40 DISP "DONE"  
50 END
```

Running the Program

Running this program causes the computer to display the sweeping message as the instrument executes the sweep. The computer will display DONE just as the instrument goes into hold. When DONE appears, the program could then continue on, being assured that there is a valid data trace in the instrument.

Preparing for Remote (HP-IB) Control

At the beginning of a program, the analyzer is taken from an unknown state and brought under remote control. This is done with an abort/clear sequence. ABORT 7 is used to halt bus activity and return control to the computer. CLEAR 716 will then prepare the analyzer to receive commands by:

- clearing syntax errors
- clearing the input-command buffer
- clearing any messages waiting to be output

The abort/clear sequence readies the analyzer to receive HP-IB commands. The next step involves programming a known state into the analyzer. The most convenient way to do this is to preset the analyzer by sending the PEES (preset) command. If preset cannot be used, the status-reporting mechanism may be employed. When using the status-reporting register, CLES (Clear Status) can be transmitted to the analyzer to clear all of the status-reporting registers and their enables.

Type SCRATCH and press **Return**.

Type EDIT and press **Return**. Type in the following program:

10 ABORT 7	<i>This halts all bus action and gives active control to the computer.</i>
20 CLEAR 716	<i>This clears all HP-IB errors, resets the HP-IB interface, and clears the syntax errors. It does not affect the status-reporting system.</i>
30 OUTPUT 716;"PRES;"	<i>Presets the instrument. This clears the status-reporting system, as well as resets all of the front-panel settings, except for the HP-IB mode and the HP-IB addresses</i>
40 END	<i>Running this program brings the analyzer to a known state, ready to respond to HP-IB control.</i>

The analyzer will not respond to HP-IB commands unless the remote line is asserted. When the remote line is asserted, the analyzer is addressed to listen for commands from the controller. In remote mode, all the front-panel keys are disabled (with the exception of **Local** and the line-power switch). ABORT 7 asserts the remote line, which remains asserted until a LOCAL 7 statement is executed. Another way to assert the remote line is to execute:

```
REMOTE 716
```

This statement asserts the analyzer's remote-operation mode and addresses the analyzer to listen for commands from the controller. Press any front-panel key except (Local). Note that none of the front-panel keys will respond until (Local has been pressed).

Local can also be disabled with the sequence:

```
REMOTE 716  
LOCAL LOCKOUT 7
```

After executing the code above, none of front-panel keys will respond. The analyzer can be returned to local mode temporarily with:

```
LOCAL 716
```

As soon as the **analyzer** is addressed to listen, it goes back into local-lockout mode. The only way to clear the local- lockout mode, aside from cycling line power, is to execute:

```
LOCAL 7
```

This command un-asserts the remote line on the interface. This puts the instrument into local mode and clears the local-lockout command. Return the instrument to remote mode by pressing:

```
Local TALKER/LISTENER
```

or

```
Local USE PASS CONTROL
```

I/O Paths

One of the features of HP BASIC is the use of input/output paths. The instrument may be addressed directly by the instrument's device number as shown in the previous examples. However, a more sophisticated approach is to declare I/O paths such as: ASSIGN **QNWa** TO 716. Assigning an I/O path builds a look-up table in the computer's memory that contains the device-address codes and several other parameters. It is easy to quickly change addresses throughout the entire program at one location. I/O operation is more efficient because it uses a table, in place of calculating or searching for values related to I/O. In the more elaborate examples where **file I/O** is discussed, the look-up table contains all the information about the file. Execution time is decreased, because the computer no longer has to calculate a device's address each time that device is addressed.

For example:

Type SCRATCH and press **(Return)**.

Type EDIT and press **(Return)**.

Type in the following program:

```
10 ASSIGN QNWa TO 716           Assigns the analyzer to ADDRESS 716.  
20 OUTPUT QNWa;"STAR 50 MHZ;" Sets the analyzer's start frequency to 50 MHz.
```

Note The use of I/O paths in binary-format transfers allows the user to quickly distinguish the type of transfer taking place. I/O paths are used throughout the examples and are highly recommended for use in device input/output.

Measurement Process

This section explains how to organize instrument commands into a measurement sequence. A typical measurement sequence consists of the following steps:

1. setting up the instrument
2. calibrating the test setup
3. connecting the device under test
4. taking the measurement data
5. post-processing the measurement data
6. transferring the measurement data

Step 1. Setting Up the Instrument

Define the measurement by setting **all** of the basic measurement parameters. These include:

- the sweep type
- the frequency span
- the sweep time
- the number of points (in the data trace)
- the RF power level
- the type of measurement
- the IF averaging
- the IF bandwidth

You **can** quickly set up an entire instrument state, using the save/recall registers and the learn string. The learn string is a summary of the **instrument** state compacted into a string that the computer reads and retransmits to the analyzer. See “Example **5A**: Using the Learn String.”

Step 2. Calibrating the Test Setup

After you have **defined** an instrument state, you should perform a measurement calibration. Although it is not required, a measurement calibration improves the accuracy of your measurement data.

The following list describes several methods to calibrate the analyzer:

- Stop the program and perform a calibration from the analyzer’s front panel.
- Use the computer to guide you through the calibration, as discussed in:
 - “Examples **2A**: **S₁₁** 1-Port Measurement Calibration”
 - “Examples **2B**: Full **2-Port** Measurement Calibration.”
 - “Example **2C**: Adapter Removal Calibration.”
 - “Example **2D**: Using Raw Data to Create a Calibration (Simmcal).”
 - “Example **2E**: **Take4** — Error Correction Processed on an External PC.”
- Transfer the calibration data from a previous calibration back into the analyzer, as **discussed** in “Example **5C**: Saving and Restoring the Analyzer **Instrument** State. ”

Step 3. Connecting the Device under Test

After you connect your test device, you can use the computer to speed up any necessary device adjustments such as limit testing, bandwidth searches, and trace statistics.

Step 4. Taking the Measurement Data

Measure the device response and set the analyzer to hold the data. This captures the data on the analyzer display.

By using the single-sweep command (SING), you can insure a valid sweep. When you use this command, the analyzer completes all stimulus changes before starting the sweep, and does not release the HP-IB hold state until it has displayed the formatted trace. Then when the analyzer completes the sweep, the instrument is put into hold mode, freezing the data. Because single sweep is OPC-compatible, it is easy to determine when the sweep has been completed.

The number-of-groups command (NUMGn) triggers multiple sweeps. It is designed to work the same as single-sweep command. NUMGn is useful for making a measurement with an averaging factor **n** (**n** can be 1 to 999). Both the single-sweep and number-of-groups commands restart averaging.

Step 5. Post-Processing the Measurement Data

Figure 1-4 shows the process functions used to affect the data after you have made an error-corrected measurement. These process functions have parameters that can be adjusted to manipulate the error-corrected data prior to formatting. They do not affect the analyzer's data gathering. The most useful functions are trace statistics, marker searches, electrical-delay offset, time domain, and gating.

After performing and activating a full **2-port** measurement calibration, any of the four Sparameters may be viewed without taking a new sweep.

Step 6. Transferring the Measurement Data

Read your measurement results. **All** the data-output commands are designed to insure that the data transmitted reflects the current state of the instrument.

BASIC Programming Examples

The following sample programs provide the user with factory-tested solutions for several remotely-controlled analyzer processes. The programs can be used in their present state or modified to suit specific needs. The programs discussed in this section can be found on the “HP 8719D/20D/22D HP BASIC Programming Examples” disk received with the analyzer.

- Example 1: Measurement Setup
 - Example **1A**: Setting Parameters
 - Example **1B**: Verifying Parameters
- Example 2: Measurement Calibration
 - Examples **2A**: **S₁₁** 1-Port Measurement Calibration
 - Examples **2B**: Full **2-Port** Measurement Calibration
 - Example **2C**: Adapter Removal Calibration
 - Example **2D**: Using Raw Data to Create a Calibration (Simmcal)
 - Example **2E**: **Take4** – Error Correction Processed on an External PC
- Example 3: Measurement Data Transfer
 - Example **3A**: Data Transfer Using Markers
 - Example **3B**: Data Transfer Using FORM 4 (ASCII Transfer)
 - Example **3C**: Data Transfer Using Floating-Point Numbers
 - Example **3D**: Data Transfer Using Frequency-Array Information
 - Example **3E**: Data Transfer Using FORM 1 (Internal Binary Format)
- Example 4: Measurement Process Synchronization
 - Example **4A**: Using the Error Queue
 - Example **4B**: Generating Interrupts
 - Example **4C**: Power Meter Calibration
- Example 5: Network Analyzer System Setups
 - Example **5A**: Using the Learn String
 - Example **5B**: Reading Calibration Data
 - Example **5C**: Saving and Restoring the Analyzer Instrument State
- Example 6: Limit-Line Testing
 - Example **6A**: Setting Up a List-Frequency Sweep
 - Example **6B**: Selecting a Sii Segment from a **Table** of Segments
 - Example **6C**: Setting Up Limit Lines
 - Example **6D**: Performing PASS/FAIL **Tests** While Tuning
- Example 7: Report Generation
 - Example **7A1**: Operation Using **Talker/Listener** Mode
 - Example **7A2**: Controlling Peripherals Using Pass-Control Mode
 - Example **7A3**: Printing with the Serial Port

- Example **7B: Plotting** to a File and Transferring the File Data to a Plotter
 - Utilizing PC-Graphics Applications Using the Plot File
- Example **7C: Reading ASCII Disk Files** to the Instrument Controller's Disk File
- Example 8: Mixer Measurements
 - Example **8A: Comparison of Two Mixers** — Group Delay, Amplitude or Phase

Program Information

The following information is provided for every example program included on the "Programming Examples" disk:

- A program description
- An outline of the program's processing sequence
- A step-by-step instrument-command-level tutorial explanation of the program including:
 - The command mnemonic and command name for the HP-IB instrument command used in the program.
 - An explanation of the operations and affects of the **HP-IB** instrument commands used in the program.

Note The HP BASIC programming code for each of these examples is contained in "HP BASIC Programming Examples."

Analyzer Features Helpful in Developing Programming Routines

Analyzer-Debug Mode

The analyzer-debug mode aids you in developing programming routines. The analyzer displays the commands being received. If a syntax error occurs, the analyzer displays the last buffer and points to the **first** character in the command line that it could not understand.

You can enable this mode from the front panel by pressing (Local) HP-IB DIAG ON The debug mode remains activated until you preset the analyzer or deactivate the mode. You can also enable this mode over the **HP-IB** using the **DEBUON ;** command and disable the debug mode using the **DEBUOFF ;** command.

User-Controllable Sweep

There are three important advantages to using the single-sweep mode:

1. The user can initiate the sweep.
2. The user can determine when the sweep has completed.
3. The user can be **confident** that the trace data has been derived from a valid sweep.

Execute the command string **OPC? ; SING;** to place the analyzer in single-sweep mode and trigger a sweep. Once the sweep is complete, the analyzer returns an ASCII character one (1) to indicate the completion of the sweep.

Note The measurement cycle and the data acquisition cycle must always be synchronized. The analyzer must complete a measurement sweep for the data to be valid.

Example 1: Measurement Setup

The programs included in Example 1 provide the user the option to perform instrument-setup functions for the analyzer from a remote controller. Example **1A** is a program designed to setup a four-parameter display. Example **1B** is a program designed to verify the measurement parameters.

Example 1A: Setting Parameters

Note This program is stored as **EXAMP1A** on the "Programming Examples" disk received with the network analyzer.

In general, the procedure for setting up measurements on the network analyzer via HP-IB follows the same sequence as if the setup was performed manually. There is no required order, as long as the desired frequency range, number of points, and power level are set prior to performing the calibration first, and the measurement second.

It is necessary to perform or recall a full two-port calibration before running this program. The calibration must be cover the frequency range of the device to be tested.

The following is an outline of the program's processing sequence:

- An I/O path is assigned for the analyzer.
- The system is initialized.
- The analyzer is adjusted to measure return loss (S_{11}) on channel 1 and display it in log magnitude.
- The analyzer is adjusted to measure return loss (S_{11}) on channel 2 and display the phase.
- The dual-channel display mode is activated.
- Interpolative error correction is turned on.
- The operator is prompted to enter the frequency range of the measurement. The operator input is used to set the start and stop frequencies.
- The displays are autoscaled.
- The operator is asked if they want a four-parameter display.
- Auxiliary channels 3 and 4 are enabled and set up.
- A four-parameter display is set up.
- The analyzer is released from remote control and the program ends.

The program is written as follows:

```
10 ! This program demonstrates setup of various measurement parameters such
20 ! as start frequency, stop frequency, etc. A full 2-port calibration
30 ! (over a frequency range which includes the range of frequency that will
40 ! be selected by the user of this program) must be performed or recalled
50 ! from memory or disk before running this program. The program first
60 ! selects a single S-parameter to be viewed using dual-channel display
70 ! format. The specified start and stop frequencies are then programmed
80 ! and the analyzer display is autoscaled. The program concludes by
90 ! displaying all four S-parameters simultaneously.
100 !
110 ! EXAMP1A
```



```

120 !
130 ASSIGN @Nwa TO 716           ! Assign an I/O path for the analyzer
140 !
150 CLEAR SCREEN
160 ! Initialize the system
170 ABORT 7                       ! Generate an IFC (Interface Clear)
180 CLEAR @Nwa                   ! SDC (Selected Device Clear) analyzer
190 !
200 ! Set up measurement and display
210 OUTPUT @Nwa;"CHAN1;"        ! Channel 1
220 OUTPUT @Nwa;"AUXCOFF;"     ! Turn off auxiliary channel, if on
230 OUTPUT @Nwa;"S11;"         ! Return Loss measurement
240 OUTPUT @Nwa;"LOGM;"        ! Log magnitude display
250 !
260 OUTPUT @Nwa;"CHAN2;"       ! Channel 2
270 OUTPUT @Nwa;"AUXCOFF;"     ! Turn off auxiliary channel, if on
280 OUTPUT @Nwa;"S11;"         ! Return Loss measurement
290 OUTPUT @Nwa;"PHAS;"        ! Phase display
300 !
310 OUTPUT @Nwa;"DUACON;"      ! Dual channel display
320 OUTPUT @Nwa;"CORION;"     ! Interpolative error correction
330 !
340 ! Request start and stop frequency
350 INPUT "ENTER START FREQUENCY (MHz):",F_start
360 INPUT "ENTER STOP FREQUENCY (MHz):",F_stop
370 !
380 ! Program the analyzer settings
390 OUTPUT @Nwa;"STAR";F_start;"MHZ;" ! Set the start frequency
400 OUTPUT @Nwa;"STOP";F_stop;"MHZ;" ! Set the stop frequency
410 !
420 ! Autoscale the displays
430 OUTPUT @Nwa;"CHAN1;AUTO;"    ! Autoscale channel 1 display
440 OUTPUT @Nwa;"CHAN2;AUTO;"    ! Autoscale channel 2 display
450 !
460 PRINT "The display should now be autoscaled."
470 INPUT "Press RETURN to view all four S-parameters simultaneously",X
480 !
490 OUTPUT @Nwa;"CHAN1;AUXCON;"  ! Turn on auxiliary channel (Channel 3)
500 OUTPUT @Nwa;"CHAN2;AUXCON;"  ! Turn on auxiliary channel (Channel 4)
510 OUTPUT @Nwa;"LOGM;AUTO;"     ! Channel 2 log magnitude and autoscale
520 OUTPUT @Nwa;"CHAN3;LOGM;AUTO;" ! Channel 3 log magnitude and autoscale
530 OUTPUT @Nwa;"CHAN4;LOGM;AUTO;" ! Channel 4 log magnitude and autoscale
540 OUTPUT @Nwa;"SPLID4;"        ! Display as four separate graticules
550 !
560 OUTPUT @Nwa;"OPC?;WAIT;"     ! Wait for the analyzer to finish
570 ENTER @Nwa;Reply             ! Read the 1 when complete
580 LOCAL @Nwa                   ! Release HP-IB control
590 END

```

Running the Program

The analyzer is initialized and sets up the parameters for channels 1 and 2. Interpolative error correction is turned on. The operator is queried for the measurement's start and stop frequencies. Channels 1 and 2 are autoscaled. The operator is asked if they want a

four-parameter display. Auxiliary channels 3 and 4 are enabled and a four-parameter display is set up. The program ends.

Example 1B: Verifying Parameters

Note This program is stored as **EXAMP1B** on the "Programming Examples" disk received with the network analyzer.

This example shows how to read analyzer settings into your controller. Chapter 1, "HP-IB Programming and Command Reference," contains additional information on the command formats and operations. Appending a "?" to a command that sets an analyzer parameter will return the value of that setting. Parameters that are set as ON or OFF when queried will return a zero (0) if **OFF** or a one (1) if active. Parameters are returned in ASCII format, FORM 4. This format is varying in length from 1 to 24 characters-per-value. In the case of marker or other multiple responses, the values are separated by commas

The following is an outline of the program's processing sequence:

- An I/O path is assigned for the analyzer.
- The system is initialized.
- The number of points in the trace is queried and dumped to a printer.
- The start frequency is queried and output to a printer.
- The averaging is queried and output to a printer.
- The analyzer is released from remote control and the program ends

The program is written as follows:

```
10 ! This program performs some example queries of network analyzer
20 ! settings. The number of points in a trace, the start frequency
30 ! and if averaging is turned on, are determined and displayed.
40 !
50 ! EXAMP1B
60 !
70 ASSIGN QNwa TO 716 ! Assign an I/O path for the analyzer
80 !
90 CLEAR SCREEN
100 ! Initialize the system
110 ABORT 7 ! Generate an IFC (Interface Clear)
120 CLEAR QNwa ! SDC (Selected Device Clear)
130 OUTPUT QNwa;"OPC?;PRES;" ! Preset the analyzer and wait
140 ENTER QNwa;Reply ! Read in the 1 returned
150 !
160 ! Query network analyzer parameters
170 OUTPUT QNwa;"POIN?;" ! Read in the default trace length
180 ENTER QNwa;Num_points
190 PRINT "Number of points ";Num_points
200 PRINT
210 !
220 OUTPUT QNwa;"STAR?;" ! Read in the start frequency
230 ENTER QNwa;Start_f
240 PRINT "Start Frequency ";Start_f
250 PRINT
260 !
270 OUTPUT QNwa;"AVERO?;" ! Averaging on?
280 ENTER QNwa;Flag
```

```

290 PRINT "Flag =";Flag;" ";
300 IF Flag=1 THEN ! Test flag and print analyzer state
310 PRINT "Averaging ON"
320 ELSE
330 PRINT "Averaging OFF"
340 END IF
350 !
360 OUTPUT @Nwa;"OPC?;WAIT;" ! Wait for the analyzer to finish
370 ENTER @Nwa;Reply ! Read the 1 when complete
380 LOCAL @Nwa ! Release HP-IB control
390 END

```

Running the Program

The analyzer is preset. The preset values are returned and printed out for: the number of points, the start frequency, and the state of the averaging function. The analyzer is released from remote control and the program ends.

Example 2: Measurement Calibration

This section shows you how to coordinate a measurement calibration over HP-IB. You can use the following sequence for performing either a manual measurement calibration, or a remote measurement calibration via HP-IB:

1. Select the calibration type.
2. Measure the calibration standards
3. Declare the calibration done.

The actual sequence depends on the calibration kit and changes slightly for **2-port** calibrations, which are divided into three calibration sub-sequences. The following examples are included:

- Example **2A** is a program designed to perform an S_{11} 1-port measurement calibration.
- Example **2B** is a program designed to perform a full **2-port** measurement calibration.
- Example **2C** is a program designed to accurately measure a “non-insertable” **2-port** device, using adapter removal.
- Example **2D** is a program designed to use raw data to create a calibration, sometimes called **Simcal**.
- Example **2E** is a program designed to offload the calculation of the **2-port** error corrected data to an external computer.

Calibration Kits

The calibration kit tells the analyzer what standards to expect at each step of the calibration. The set of standards associated with a given calibration is termed a “class.” For example, measuring the short during an S_{11} 1-port measurement calibration is one calibration step. All of the shorts that can be used for this calibration step make up the class, which is called class **S11B**. For the **7-mm** and the **3.5-mm** cal kits, class **S11B** uses only one standard. For type-N cal kits, class **S11B** contains two standards: male and female shorts

When doing an S_{11} 1-port measurement calibration using a **7-** or **3.5-mm** calibration kit, selecting **SHORT** automatically measures the short because the class contains only one standard. When doing the same calibration in type-N, selecting **SHORT** brings up a second menu, allowing the operator to select which standard in the class is to be measured. The sex listed refers to the test port: if the test port is female, then the operator selects the female short option. Once the standard has been selected and measured, the **DONE** key must be pressed to exit the class

Doing an S_{11} 1-port measurement calibration over **HP-IB** is very similar. When using a **7-** or **3.5-mm** calibration kit, sending **CLASS11B** will automatically measure the short. In type-N, sending **CLASS11B** brings up the menu with the male and female short options. To select a standard, use **STANA** or **STANB**. The **STAN** command is appended with the letters A through G, corresponding to the standards listed under **softkeys** 1 through 7, **softkey** 1 being the topmost **softkey**.

The **STAN** command is OPC-compatible. A command that **calls** a class is only OPC-compatible if that class has only one standard in it. If there is more than one standard in a class, the command that calls the class brings up another menu, and there is no need to query it. **DONE** must be sent to exit the class

Example 2A: S11 1-Port Calibration

Note This program is stored as **EXAMP2A** on the "Programming Examples" disk received with the network analyzer.

The following program performs an S11 1-port calibration, using either the HP 85031B 7-mm calibration kit or the HP 85033D 3.5-mm calibration kit. *If you wish to use a different calibration kit, modify the example program accordingly.* This program simplifies the calibration by providing explicit directions on the analyzer display while allowing the user to run the program from the controller keyboard. More information on selecting calibration standards can be found in the **Optimizing Measurement Results** chapter of the *HP 8719D/20D/22D Network Analyzer User's Guide*.

The following is an outline of the program's processing sequence:

- An I/O path is assigned for the analyzer.
- The system is initialized.
- The appropriate calibration kit is selected.
- The **softkey** menu is deactivated.
- The S11-calibration sequence is **run**.
- The S11-calibration data is saved.
- The **softkey** menu is activated.
- The analyzer is released from remote control and the program ends.

The program is written as follows:

```
1  ! This program guides the operator through a 1-port calibration.
2  ! The operator must choose either the HP 85031B 7 mm calibration kit
3  ! or the HP 85033D 3.5 mm calibration kit.
4  ! The routine Waitforkey displays a message on the instrument's
5  ! display and the console, to prompt the operator to connect the
6  ! calibration standard. Once the standard is connected, the
7  ! ENTER key on the computer keyboard is pressed to continue.
8  !
9  ! EXAMP2A
10 !
11 ASSIGN @Nwa TO 716           ! Assign an I/O path for the analyzer
12 !
13 CLEAR SCREEN
14 ! Initialize the system
15 ABORT 7                     ! Generate an IFC (Interface Clear)
16 CLEAR @Nwa                  ! SDC (Selected Device Clear)
17 ! Select CAL kit type
18 INPUT "Enter a 1 to use the HP 85031B kit, 2 to use the HP 85033D kit",Kit
19 IF Kit=1 THEN
20 OUTPUT @Nwa;"CALK7MM;"
21 ELSE
22 OUTPUT @Nwa;"CALK35MD;"
23 END IF
24 !
```

```

25 OUTPUT @Nwa;"MENUOFF;"          ! Turn softkey menu off.
26 !
27 OUTPUT @Nwa;"CALIS111;"         ! S11 1 port CAL initiated
28 !
29 CALL Waitforkey("CONNECT OPEN AT PORT 1")
30 OUTPUT @Nwa;"OPC?;CLASS11A;"    ! Open reflection CAL
31 ENTER @Nwa;Reply               ! Read in the 1 returned
32 OUTPUT @Nwa;"DONE;"            ! Finished with class standards
33 !
34 CALL Waitforkey("CONNECT SHORT AT PORT 1")
35 OUTPUT @Nwa;"OPC?;CLASS11B;"    ! Short reflection CAL
36 ENTER @Nwa;Reply               ! Read in the 1 returned
37 OUTPUT @Nwa;"DONE;"            ! Finished with class standards
38 !
39 CALL Waitforkey("CONNECT LOAD AT PORT 1")
40 IF Kit=1 THEN                   ! Reflection load CAL
41 OUTPUT @Nwa;"OPC?;CLASS11C;"
42 ELSE
43 OUTPUT @Nwa;"CLASS11C;"
44 OUTPUT @Nwa;"OPC?;STANA;"
45 END IF
46 !
47 ENTER @Nwa;Reply               ! Read in the 1 returned
48 !
49 OUTPUT 717;"PG;"                ! Clear the analyzer display
50 !
51 DISP "COMPUTING CALIBRATION COEFFICIENTS"
52 !
53 OUTPUT @Nwa;"OPC?;SAV1;"        ! Save the ONE PORT CAL
54 ENTER @Nwa;Reply               ! Read in the 1 returned
55 !
56 DISP "S11 I-PORT CAL COMPLETED. CONNECT TEST DEVICE."
57 OUTPUT @Nwa;"MENUON;"          ! Turn on the softkey menu
58 !
59 OUTPUT @Nwa;"OPC?;WAIT;"        ! Wait for the analyzer to finish
60 ENTER @Nwa;Reply               ! Read the 1 when complete
61 LOCAL @Nwa                      ! Release HP-IB control
62 !
63 END
64 !
65 ! ***** Subroutines *****
66 !
67 Waitforkey:      ! Prompt routine to read a keypress on the controller
68 SUB Waitforkey(Lab$)
69 !   Position and display text on the analyzer display
70 OUTPUT 717;"PG;PU;PA390,3700;PD;LB";Lab$," , PRESS ENTER WHEN READY;"&CHR$(3)
71 !
72 DISP Lab$&&" Press ENTER when ready"; ! Display prompt on console
73 INPUT A$         ! Read ENTER key press
74 !
75 OUTPUT 717;"PG;" ! Clear analyzer display
76 SUBEND

```

Running the Program

Note This program does not modify the instrument state in any way. Before running the program, set up the desired instrument state.

The program assumes that the test ports have either a **7-mm** or **3.5-mm** interface or an adapter set using either a **7-mm** or **3.5-mm** interface. The prompts appear just above the message line on the analyzer display. Pressing **(ENTER)** on the controller keyboard continues the program and measures the standard. The program will display a message when the measurement calibration is complete.

Example 2B: Full 2-Port Measurement Calibration

Note This program is stored as **EXAMP2B** on the “Programming Examples” disk received with the network analyzer.

The following example program performs a full **2-port** measurement calibration using either the HP **85031B 7-mm** calibration kit or the HP **85033D 3.5-mm** calibration kit. *If you wish to use a different calibration kit, modify the example program accordingly.* A full **2-port** calibration removes both the forward- and reverse-error terms so all four S-parameters of the device under test can be measured. PORT 1 is a female test port and PORT 2 is a male test port.

The following is an outline of the program’s processing sequence:

- An I/O path is assigned for the analyzer.
- The system is initialized.
- The appropriate calibration kit is selected.
- The **softkey** menu is deactivated.
- The **2-port** calibration sequence is run.
- The operator is prompted to choose or skip the isolation calibration.
- The **softkey** menu is activated.
- The **analyzer** is released from remote control and the program ends

The program is written as follows:

```
1  ! This program guides the operator through a full 2-port calibration.
2  ! The operator must choose either the HP 85031B 7 mm calibration kit
3  ! or the HP 85033D 3.5 mm calibration kit.
4  ! The routine Waitforkey displays a message on the instrument's
5  ! display and the console to prompt the operator to connect the
6  ! calibration standard. Once the standard is connected, the
7  ! ENTER key on the computer keyboard is pressed to continue.
8  !
9  ! EXAMP2B
10 !
11 ASSIGN ONva TO 716           ! Assign an I/O path to the analyzer
12 !
13 CLEAR SCREEN
14 ! Initialize the analyzer
```



```

15 ABORT 7 ! Generate an IFC (Interface Clear)
16 CLEAR @Nwa ! SDC (Selected Device Clear)
17 ! Select CAL kit type
18 INPUT "Enter a 1 to use the HP 85031B kit, 2 to use the HP 85033D kit",Kit
19 IF Kit=1 THEN
20 OUTPUT @Nwa;"CALK7MM;"
21 ELSE
22 OUTPUT @Nwa;"CALK35MD;"
23 END IF
24 !
25 OUTPUT @Nwa;"MENUOFF;" ! Turn softkey menu off.
26 !
27 OUTPUT @Nwa;"CALIFUL2;" ! Full 2 port CAL
28 !
29 OUTPUT @Nwa;"REFL;" ! Reflection CAL
30 !
31 CALL Waitforkey("CONNECT OPEN AT PORT 1")
32 OUTPUT @Nwa;"OPC?;CLASS11A;" ! S11 open CAL
33 ENTER @Nwa;Reply ! Read in the 1 returned
34 OUTPUT @Nwa;"DONE;" ! Finished with class standards
35 !
36 CALL Waitforkey("CONNECT SHORT AT PORT 1")
37 OUTPUT @Nwa;"OPC?;CLASS11B;" ! S11 short CAL
38 ENTER @Nwa;Reply ! Read in the 1 returned
39 OUTPUT @Nwa;"DONE;" ! Finished with class standards
40 !
41 CALL Waitforkey("CONNECT LOAD AT PORT 1")
42 IF Kit=1 THEN ! S11 load CAL
43 OUTPUT @Nwa;"OPC?;CLASS11C;"
44 ELSE
45 OUTPUT @Nwa;"CLASS11C;"
46 OUTPUT @Nwa;"OPC?;STANA;"
47 END IF
48 !
49 ENTER @Nwa;Reply ! Read in the 1 returned
50 !
51 CALL Waitforkey("CONNECT OPEN AT PORT 2")
52 OUTPUT @Nwa;"OPC?;CLASS22A;" ! S22 open CAL
53 ENTER @Nwa;Reply ! Read in the 1 returned
54 OUTPUT @Nwa;"DONE;" ! Finished with class standards
55 !
56 CALL Waitforkey("CONNECT SHORT AT PORT 2")
57 OUTPUT @Nwa;"OPC?;CLASS22B;" ! S22 short CAL
58 ENTER @Nwa;Reply ! Read in the 1 returned
59 OUTPUT @Nwa;"DONE;" ! Finished with class standards
60 !
61 CALL Waitforkey("CONNECT LOAD AT PORT 2")
62 IF Kit=1 THEN ! S22 load CAL
63 OUTPUT @Nwa;"OPC?;CLASS22C;"
64 ELSE
65 OUTPUT @Nwa;"CLASS22C;"
66 OUTPUT @Nwa;"OPC?;STANA;"
67 END IF
68 !
69 ENTER @Nwa;Reply

```

```

70 !
71 DISP "COMPUTING REFLECTION CALIBRATION COEFFICIENTS"
72 !
73 OUTPUT @Nwa;"REFD;"           ! Reflection portion complete
74 !
75 OUTPUT @Nwa;"TRAN;"          ! Transmission portion begins
76 !
77 CALL Waitforkey("CONNECT THRU [PORT1 TO PORT 2]")
78 DISP "MEASURING FORWARD TRANSMISSION"
79 OUTPUT @Nwa;"OPC?;FWDI;"      ! Measure forward transmission
80 ENTER @Nwa;Reply              ! Read in the 1 returned
81 !
82 OUTPUT @Nwa;"OPC?;FWDI;"      ! Measure forward load match
83 ENTER @Nwa;Reply              ! Read in the 1 returned
84 !
85 DISP "MEASURING REVERSE TRANSMISSION"
86 OUTPUT @Nwa;"OPC?;REV1;"      ! Measure reverse transmission
87 ENTER @Nwa;Reply              ! Read in the 1 returned
88 !
89 OUTPUT @Nwa;"OPC?;REV1;"      ! Measure reverse load match
90 ENTER @Nwa;Reply              ! Read in the 1 returned
91 !
92 OUTPUT @Nwa;"TRAD;"           ! Transmission CAL complete
93 !
94 INPUT "SKIP ISOLATION CAL? Y OR N.",An$
95 IF An$="Y" THEN
96 OUTPUT @Nwa;"OMII;"           ! Skip isolation cal
97 GOTO 114
98 END IF
99 !
100 CALL Waitforkey("ISOLATE TEST PORTS")
101 !
102 OUTPUT @Nwa;"ISOL;"           ! Isolation CAL
103 OUTPUT @Nwa;"AVERFACT10;"     ! Average for 10 sweeps
104 OUTPUT @Nwa;"AVEROON;"        ! Turn on averaging
105 DISP "MEASURING REVERSE ISOLATION"
106 OUTPUT @Nwa;"OPC?;REVI;"      ! Measure reverse isolation
107 ENTER @Nwa;Reply              ! Read in the 1 returned
108 !
109 DISP "MEASURING FORWARD ISOLATION"
110 OUTPUT @Nwa;"OPC?;FWDI;"      ! Measure forward isolation
111 ENTER @Nwa;Reply              ! Read in the 1 returned
112 !
113 OUTPUT @Nwa;"ISOD;AVEROOFF;"  ! Isolation complete averaging off
114 OUTPUT 717;"PG;"              ! Clear analyzer display prompt
115 !
116 DISP "COMPUTING CALIBRATION COEFFICIENTS"
117 OUTPUT @Nwa;"OPC?;SAV2;"      ! Save THE TWO PORT CAL
118 ENTER @Nwa;Reply              ! Read in the 1 returned
119 !
120 DISP "DONE WITH FULL 2-PORT CAL. CONNECT TEST DEVICE."
121 OUTPUT @Nwa;"MENUON;"         ! Turn softkey menu on
122 !
123 OUTPUT @Nwa;"OPC?;WAIT;"      ! Wait for the analyzer to finish
124 ENTER @Nwa;Reply              ! Read the 1 when complete

```

```

125 LOCAL @Nwa                ! Release HP-IB control
126 !
127 END
128 !
129 ! ***** Subroutines *****
130 !
131 SUB Waitforkey(Lab$)
132     ! Position and display prompt on the analyzer display
133 OUTPUT 717;"PG;PU;PA390,3700;PD;LB";Lab$," , PRESS ENTER WHEN READY;"&CHR$(3)
134     !
135 DISP Lab$&"    Press ENTER when ready";          ! Display prompt on console
136 INPUT A$                                           ! Read ENTER keypress on controller
137 OUTPUT 717;"PG;"                                   ! Clear analyzer display
138 SUBEND

```

Running the Program

Note Before running the program, set the desired instrument state. This program does not modify the instrument state in any way.

Run the program and connect the standards as prompted. After the standard is connected, press **(ENTER)** on the controller keyboard to continue the program.

The program assumes that the test ports have either a **7-mm** or **3.5-mm** interface or an adapter set using either a **7-mm** or **3.5-mm** interface. The prompts appear just above the message line on the analyzer display. After the prompt is displayed, pressing **(ENTER)** on the computer console continues the program and measures the standard. The operator has the option of omitting the isolation calibration. If the isolation calibration is performed, averaging is automatically employed to insure a good calibration. The program will display a message when the measurement calibration is complete.

Example 2C: Adapter Removal Calibration

Note This program is stored as **EXAMP2C** on the "Programming Examples" disk received with the network analyzer.

This program shows how to accurately measure a "non-insertable" **2-port** device. A device is termed "non-insertable" if its connectors do not match those of the analyzer front panel. More information on the adapter removal technique can be found in the "Optimizing Measurement Results" chapter of the *HP 8719D/8720D/8722D Network Analyzer User's Guide*.

The following is an outline of the program's processing sequence:

- An I/O path is assigned for the analyzer.
- The system is initialized.
- The internal disk is selected as the active storage device.
- The system operator is prompted for the name of the instrument state **file** which has a **2-port** calibration performed for Port 1's connector.
- The calibration arrays for Port 1 are recalled from the corresponding disk **file**.
- The system operator is prompted for the known electrical delay value of the adapter.
- The new calibration coefficients' with the effects of the adapter removed, are computed by the analyzer using the adapter delay in conjunction with the calibration arrays for both ports
- The analyzer is released from remote control and the program ends

The program is written as follows:

```
1      ! This program demonstrates how to do adapter removal over HP-IB.
2      !
3      ! EXAMP2C
4      !
5 REAL Delay                                !Adapter electrical delay in picoseconds
6      !
7 ASSIGN @Nwa TO 716                        ! Assign an I/O path for the analyzer
8 CLEARSCREEN
9      ! Initialize the system
10 ABORT 7                                  ! Generate an IFC (Interface Clear)
11 CLEAR @Nwa                               ! SDC (Selected Device Clear) analyzer
12 OUTPUT @Nwa;"OPC?;PRES;"                ! Preset the analyzer and wait
13 ENTER @Nwa;Reply                          ! Read in the 1 returned
14      !
15      ! Select internal disk.
16      !
17 OUTPUT @Nwa;"INTD;"
18      !
19      ! Assign file X1 to the filename that has a 2-port
20      ! cal previously performed for Port 1's connector.
21      !
22 PRINT "Enter the name of the instrument state file which"
23 PRINT "has a 2-port cal performed for Port 1's connector"
24 INPUT "",F1$
25 OUTPUT @Nwa;"TITF1""";F1$;"";"
26      !
```

```

27     ! Recall the cal set for Port 1.
28     !
29 DISP "Loading cal arrays, please wait"
30 OUTPUT @Nwa;"CALSPORT1;"
31 OUTPUT @Nwa;"OPC?;NOOP;"
32 ENTER @Nwa;Reply
33     !
34     ! Assign file #2 to the filename that has a 2-port
35     ! cal previously performed for Port 2's connector.
36     !
37 CLEAR SCREEN
38 PRINT "Enter the name of the instrument state file which"
39 PRINT "has a 2-port cal performed for Port 2's connector"
40 INPUT "",F2$
41 OUTPUT @Nwa;"INTD;TITF2""";F2$;""";"
42     !
43     ! Recall the cal set for Port 2.
44     !
45 DISP "Loading cal arrays, please wait"
46 OUTPUT @Nwa;"CALSPORT2;"
47 OUTPUT @Nwa;"OPC?;NOOP;"
48 ENTER @Nwa;Reply
49     !
50     ! Set the adapter electrical delay.
51     !
52 INPUT "Enter the electrical delay for the adapter in picoseconds",
Delay
53 OUTPUT @Nwa;"ADAP1"&VAL$(Delay)&"PS;"
54     !
55     ! Perform the "remove adapter" computation.
56     !
57 DISP "Computing cal coefficients..."
58 OUTPUT @Nwa;"MODS;"
59 OUTPUT @Nwa;"OPC?;WAIT;"
60 ENTER @Nwa;Reply
61 LOCAL 7                               ! Release BP-IB control
62 DISP "Program completed"
63 END

```

Running the Program

The analyzer is initialized and the internal disk drive is selected. The operator is queried for the name of the instrument state **file** having a **2-port** calibration performed for Port 1's connector. The calibration arrays for Port 1 are recalled from the corresponding disk file. The system operator is prompted for the name of the instrument state **file** having a **2-port** calibration performed for Port **2's** connector. The calibration arrays for Port 2 are recalled from the corresponding disk **file**. The system operator is prompted for the known electrical delay of the adapter and this value is written to the analyzer. The calibration coefficients with adapter effects removed are computed and the program ends

Example 2D: Using Raw Data to Create a Calibration (Simmcal)

Note This program is stored as **EXAMP2D** on the “Programming Examples” disk received with the network analyzer.

This program simulates a full **2-port** cal by measuring the raw data for each “standard” and then loading it later into the appropriate arrays. The program can be adapted to create additional calibrations using the same arrays. It uses the **HP85031B 7-mm** cal kit.

Caution This feature is not currently supported with TRL calibrations

The following is an outline of the programs’ processing sequence:

- An I/O path is assigned for the analyzer.
- The system is initiated.
- The number of points is set to correspond to the size of the dimensioned memory arrays and ASCII data format is selected.
- The **7-mm** calibration kit is selected, sweep time is set to 1 second, and the analyzer is placed into hold mode.
- **S11** measurement is selected for gathering the forward reflection standards
- The system operator is prompted to connect each of the three standards, one at a time.
- Following each prompt, a single sweep is taken and the raw measured data for that standard is read from the analyzer into a corresponding memory array in the controller.
- **S22** measurement is selected for gathering the reverse reflection standards.
- The system operator is prompted in the same manner as before and the raw data for the three standards is measured and stored away as before.
- The system operator is prompted to make the thru connection between Port 1 and Port 2.
- **S21** measurement is selected, a single sweep is taken and the raw data is read into an array corresponding to forward transmission.
- **S11** measurement is selected, a single sweep is taken and the raw data is read into an array corresponding to forward thru match.
- **S12** measurement is selected, a single sweep is taken and the raw data is read into an array corresponding to reverse transmission.
- **S22** measurement is selected, a single sweep is taken and the raw data is read into an array corresponding to reverse thru match.
- The analyzer begins the normal **2-port** calibration procedure, but with the default beep turned off.
- A single sweep is taken for the measurement of each standard to provide “dummy” data, which is immediately replaced with the previously measured raw data from the array corresponding to that measurement.
- The analyzer uses the raw data to compute the error coefficients and is placed back into continuous sweep mode.
- The analyzer is released from remote control and the program ends

The program is written as follows:

```
1      ! This program simulates a full 2-port cal by first getting the
2      ! raw data for each "standard" and then loading it into the
3      ! appropriate arrays later.  For simplicity, this is done with
4      ! ASCII format, 51 points, and the default calibration kit in the
5      ! 8753D (7mm).  This also simplifies the input of the standards
6      ! because there is only one standard associated with a particular
7      ! class with the default 7mm cal kit.  See notes below for how to
8      ! handle multiple standards for a particular class.
9      !
10     ! EXAMP2D
11     !
12     ! Allocate the arrays.  The numbers correspond to the subsequent
13     ! cal coefficient array that will be written.
14     !
15     DIM Array01(1:51,1:2)      ! forward OPEN measurement
16     DIM Array02(1:51,1:2)      ! forward SHORT
17     DIM Array03(1:51,1:2)      ! forward LOAD
18     DIM Array04(1:51,1:2)      ! forward ISOLATION if necessary
19     DIM Array05(1:51,1:2)      ! forward LOAD MATCH
20     DIM Array06(1:51,1:2)      ! forward TRANS
21     DIM Array07(1:51,1:2)      ! reverse OPEN
22     DIM Array08(1:51,1:2)      ! reverse SHORT
23     DIM Array09(1:51,1:2)      ! reverse LOAD
24     DIM Array10(1:51,1:2)     ! reverse ISOLATION if necessary
25     DIM Array11(1:51,1:2)     ! reverse LOAD MATCH
26     DIM Array12(1:51,1:2)     ! reverse TRANS
27     !
28     ! Initialize the system
29     ASSIGN ONwa TO 716          ! Assign an I/O path for the analyzer
30     ABORT 7                      ! Generate an IFC (Interface Clear)
31     CLEAR ONwa                 ! SDC (Selected Device Clear) analyzer
32     CLEAR SCREEN
33     !
34     ! Preset the analyzer, set to 51 points, ASCII format, desired cal
35     ! kit definition (7mm for 8753D).  Sweep time set to 1 second
36     ! (could be whatever user would like), analyzer put in hold mode.
37     !
38     OUTPUT ONwa;"opc?;pres;"
39     ENTER ONwa;X
40     OUTPUT ONwa;"POIN51;FORM4;"
41     OUTPUT ONwa;"CALK7MM;SWET1S;HOLD;"
42     !
43     ! Select S11 to gather the forward reflection standards
44     ! (open, short, load).
45     !
46     OUTPUT ONwa;"S11;"
47     INPUT "CONNECT OPEN AT PORT 1",X
48     OUTPUT ONwa;"opc?;sing;"
49     ENTER ONwa;X
50     BEEP
51     OUTPUT ONwa;"OUTPRAW1"
52     ENTER ONwa;Array01(*)
```

```

53  !
54 INPUT "CONNECT SHORT AT PORT 1",X
55 OUTPUT @Nwa;"opc?;sing;"
56 ENTER @Nwa;X
57 BEEP
58 OUTPUT @Nwa;"OUTPRAW1"
59 ENTER @Nwa;Array02(*)
60  !
61 INPUT "CONNECT BROADBAND LOAD AT PORT 1",X
62 OUTPUT @Nwa;"opc?;sing;"
63 ENTER @Nwa;X
64 BEEP
65 OUTPUT @Nwa;"OUTPRAW1"
66 ENTER @Nwa;Array03(*)
67  !
68  ! Now select S22 to gather the reverse reflection standards.
69  !
70 OUTPUT @Nwa;"S22"
71 INPUT "CONNECT OPEN AT PORT 2",X
72 OUTPUT @Nwa;"opc?;sing;"
73 ENTER @Nwa;X
74 BEEP
75 OUTPUT @Nwa;"OUTPRAW1"
76 ENTER @Nwa;Array07(*)
77  !
78 INPUT "CONNECT SHORT AT PORT 2",X
79 OUTPUT @Nwa;"opc?;sing;"
80 ENTER @Nwa;X
81 BEEP
82 OUTPUT @Nwa;"OUTPRAW1"
83 ENTER @Nwa;Array08(*)
84  !
85 INPUT "CONNECT BROADBAND LOAD AT PORT 2",X
86 OUTPUT @Nwa;"opc?;sing;"
87 ENTER @Nwa;X
88 BEEP
89 OUTPUT @Nwa;"OUTPRAW1"
90 ENTER @Nwa;Array09(*)
91  !
92 INPUT "CONNECT THRU [PORT1 TO PORT 2]",X
93  !
94  ! Now select S21 to gather forward transmission raw array.
95  !
96 DISP "MEASURING FORWARD TRANSMISSION"
97 OUTPUT @Nwa;"S21;OPC?;SING;"
98 ENTER @Nwa;Reply
99 BEEP
100 OUTPUT @Nwa;"OUTPRAW1"
101 ENTER @Nwa;Array06(*)
102  !
103  ! Now select S11 to gather forward match raw array.
104  !
105 OUTPUT @Nwa;"S11;OPC?;SING;"
106 ENTER @Nwa;Reply
107 BEEP

```



```

108 OUTPUT @Nwa;"OUTPRAW1"
109 ENTER @Nwa;Array05(*)
110 !
111 ! Now select S12 for reverse transmission raw array.
112 !
113 DISP "MEASURING REVERSE TRANSMISSION"
114 OUTPUT @Nwa;"S12;OPC?;SING;"
115 ENTER @Nwa;Reply
116 BEEP
117 OUTPUT @Nwa;"OUTPRAW1"
118 ENTER @Nwa;Array12(*)
119 !
120 ! Now select S22 for reverse match raw array.
121 !
122 OUTPUT @Nwa;"S22;OPC?;SING;"
123 ENTER @Nwa;Reply
124 BEEP
125 OUTPUT @Nwa;"OUTPRAW1"
126 ENTER @Nwa;Array11(*)
127 !
128 ! Done with gathering measurements except for isolation. If
129 ! isolation desired, then put forward isolation into 'Array04',
130 ! reverse isolation into 'Array10'.
131 !
132 ! Now download and let analyzer compute the full 2-port error
133 ! correction.
134 !
135 ! First select the calibration type desired.
136 !
137 OUTPUT @Nwa;"CALIFUL2;"
138 !
139 ! Turn off the beep indicating standard done.
140 !
141 OUTPUT @Nwa;"BEEPDONEOFF;"
142 !
143 ! Set up for the reflection standards.
144 !
145 OUTPUT @Nwa;"REFL;"
146 !
147 ! Input the forward 'open' standard's raw array. For all of
148 ! these, the analyzer is first taking a "dummy" measurement, goes
149 ! into hold, then the computer downloads the data using an
150 ! INPUCALC command which overwrites the "dummy" data with the raw
151 ! array gathered previously.
152 !
153 OUTPUT @Nwa;"OPC?;CLASS11A;"
154 ENTER @Nwa;Reply
155 OUTPUT @Nwa;"INPUCALC01",Array01(*)
156 !
157 ! Input the forward 'short standard's raw array.
158 !
159 OUTPUT @Nwa;"OPC?;CLASS11B;"
160 ENTER @Nwa;Reply
161 OUTPUT @Nwa;"INPUCALC02",Array02(*)
162 !

```

```

163 ! Input the forward 'load' standards's raw array.
164 !
165 OUTPUT @Nwa;"OPC?;CLASS11C;"
166 ENTER @Nwa;Reply
167 OUTPUT @Nwa;"INPUCALC03",Array03(*)
168 !
169 ! NOTE: When there are multiple standards for a specific "class",
170 ! it is necessary to use the specific standard assigned in
171 ! addition to using the CLASSxxn command. For example:
172 !
173 !           OUTPUT@Nwa;"CLASS11C;OPC?;STANA;"
174 !
175 ! Input reverse 'open'.
176 !
177 OUTPUT @Nwa;"OPC?;CLASS22A;"
178 ENTER @Nwa;Reply
179 OUTPUT @Nwa;"INPUCALC07",Array07(*)
180 !
181 ! Input reverse 'short'.
182 !
183 OUTPUT @Nwa;"OPC?;CLASS22B;"
184 ENTER @Nwa;Reply
185 OUTPUT @Nwa;"INPUCALC08",Array08(*)
186 !
187 ! Input reverse 'load'.
188 !
189 OUTPUT @Nwa;"OPC?;CLASS22C;"
190 ENTER @Nwa;Reply
191 OUTPUT @Nwa;"INPUCALC09",Array09(*)
192 !
193 ! Tell analyzer that reflection measurements done.
194 !
195 OUTPUT @Nwa;"REFD;"
196 DISP "COMPUTING REFLECTION CALIBRATION COEFFICIENTS"
197 !
198 ! Now start the transmission standard downloads.
199 !
200 OUTPUT @Nwa;"TRAN;"
201 !
202 ! Now input the forward transmission raw arrays.
203 !
204 OUTPUT @Nwa;"OPC?;FWDT;"
205 ENTER @Nwa;Reply
206 OUTPUT @Nwa;"INPUCALC06",Array06(*)
207 !
208 OUTPUT @Nwa;"OPC?;FWDM;"
209 ENTER @Nwa;Reply
210 OUTPUT @Nwa;"INPUCALC05",Array05(*)
211 !
212 ! Now input the reverse transmission arrays.
213 !
214 !DISP "MEASURING REVERSE TRANSMISSION"
215 OUTPUT @Nwa;"OPC?;REVT;"
216 ENTER @Nwa;Reply
217 OUTPUT @Nwa;"INPUCALC12",Array12(*)

```

```

218  !
219 OUTPUT @Nwa;"OPC?;REVM;"
220 ENTER @Nwa;Reply
221 OUTPUT @Nwa;"INPUCALC11",Array11(*)
222  !
223  ! Tell analyzer that transmission inputs done.
224  !
225 OUTPUT @Nwa;"TRAD"
226  !
227  ! Omitting isolation for this example. Could be easily
228  ! incorporating by using method shown for tranmission and
229  ! reflection.
230  !
231 OUTPUT @Nwa;"ISOL;"
232 OUTPUT @Nwa;"OMII;"           !IF ISOLATION CAL NOT DESIRED
233  ! Here's how to download isolation. Un-comment these lines.
234  !
235  ! OUTPUT @Nwa;"OPC?;REVI;" ! reverse isolation term
236  !ENTER @Nwa;Reply
237  !OUTPUT @Nwa;"INPUCALC10",Array10(*)
238  !
239  ! OUTPUT @Nwa;"OPC?;FWDI;" ! forward isolation term
240  !ENTER @Nwa;Reply
241  ! OUTPUT @Nwa;"INPUCALC04",Array04(*)
242  !
243  ! Tell analyzer that done with isolation measurements.
244  !
245 OUTPUT @Nwa;" ISOD ;"
246 DISP "COMPUTING CALIBRATION COEFFICIENTS"
247  !
248  ! Tell analyzer to compute full 2-port error coefficients.
249  !
250 OUTPUT @Nwa;"OPC? ; SAV2;"
251 ENTER @Nwa;Reply
252 DISP "DONE"
253  !
254  ! Put analyzer back into continuous sweep so that you can verify
255  ! the proper application of the error correction.
256  !
257 OUTPUT @Nwa;"CONT;"
258 OUTPUT @Nwa;"BEEPDONEON;"    ! Re-enable the beep
259 LOCAL 7                      ! Release HP-IB control
260 END

```

Running the Program

The system is initialized, **the** number of points is set to 51, and the **7-mm** calibration kit is selected. Sweep time is set to 1 second and the analyzer is placed into hold mode.

The **S11** measurement is selected and the system operator is prompted to connect each of the three forward reflection standards, one at a time. Following each prompt, a single sweep is taken, which concludes with a beep from the external controller.

The **S22** measurement is selected for gathering **the** reverse reflection standards. The system operator is prompted in the same manner as before and the three standards are measured as before.

The system operator is prompted to make the thru connection between Port 1 and Port 2. A single sweep is taken for each of the four S-parameters, each concluding with a beep.

The analyzer begins the normal **2-port** calibration procedure, but with the default beep turned off. A single sweep is taken for each measurement of each standard, providing “dummy” data which is immediately replaced with the data from the array corresponding to that measurement. The analyzer computes the error correction coefficients and is placed back into continuous sweep mode. The default beep is re-enabled and the program ends

Example 2E: Take4 — Error Correction Processed on an External PC

Note This program is stored as **EXAMP2E** on the “Programming Examples” disk received with the network analyzer.

Overview

Take4 mode offloads the error correction process to an external PC in order to increase throughput on the analyzer.

When using the analyzer with error correction turned off, it will only sweep in one direction, collecting data for the parameter selected under the **(MEAS)** key. To emulate the error correction process in an external computer, you collect the raw data for each of the four S-parameters.

Take4 initiates a mode in which every measurement cycle is characterized by sweeping in both the forward and reverse directions and collecting raw data for all four S-parameters. Using previously extracted calibration arrays, you can then extract the raw data (or the pre-raw data, as explained later in this section) for the S-parameters and perform the error correction in an external computer. This process can be done in less time than a single corrected parameter can be measured and transferred using the normal instrument error correction and data transfer (see Table 2-3).

Note This mode is intended for remote use only. Any attempt to change the measured parameter or any attempt to apply a calibration will turn off the **Take4** mode. The displayed trace data is always uncorrected **S11**, regardless of what the display may indicate.

Using the Take4 Mode

Using the **Take4** mode requires the following steps:

Manual steps:

1. Set up the measurement state.
2. Turn off raw offsets by selecting **(SYSTEM) CONFIGURE MENU, RAW OFFSET OFF**. This selection achieves two things:
 - Eliminates attenuator offsets and sampler hardware offsets from the cal arrays, which are generated in the 2-port error correction. This makes the **cal** arrays and the eventual **OUTPPRE** arrays compatible, both using pre-raw data (see Fig 1-3).
 - Eliminates sampler correction, a frequency response correction that is normally contained in pre-raw data. This is done because sampler correction is not needed for data that **will** be fully corrected, and because instrument states recall faster without it. To realize this efficiency, you must also disable spur avoidance (see next step).
3. Perform a **2-port** error correction and save it to a register.
4. **Connect** the device under test (**DUT**).

The instrument is now **configured** for the program to read the correction arrays and apply the **Take4** mode.

Programming steps:

5. Extract the twelve calibration arrays using the commands **OUTPCALC[01-12]**.
6. Enable **Take4** mode using the **command TAKE4ON**.
7. **Take** a sweep and extract the four pre-raw or raw arrays
 - If extract pre-raw data arrays (see previous **discussion** on raw offsets), you can use the commands **SWPSTART** (initiate a single sweep) with **OUTPPRE[1-4]**. These commands

are more efficient than SING and OUTPRAF[1-4] because the analyzer will respond to OUTPPRE1 and OUTPPRE2 as soon as the forward sweep is done and transfer the data during the reverse sweep. With SING, the HP-IB bus is held off until the entire sweep is complete.

- If extract raw data arrays, you can use the commands SING (initiate a single sweep) with OUTPRAW[1-4], or the slightly faster OUTPRAF[1-4]. If the cal arrays were created using RAW OFFSET ON, you should use this method so that your measurement data is compatible with the calibration data.
8. Apply the calibration arrays (see Table 1-7) to either the pre-raw or raw data as described in programming example 2G and in the User's Guide (see figure titled "Full 2-Port Error Model" in chapter 6).

Table 2-3.
Measurement Speed: Data Output and Error Correction to an External PC*

Mode (data output to external PC)	Time (secs) 1-parameter	Time (secs) 2-parameters	Time (secs) 3-parameters	Time (secs) 4-parameters
Full band, IF BW = 3700, 201 points, RAW OFFSET OFF				
Take4	1.59	1.59	1.59	1.59
Normal error correction	1.78	1.86	2.06	2.25
Narrow band, IF BW = 3700, 201 points, CF = 1.8GHz, Span = 200MHz, RAW OFFSET OFF				
Take4	0.56	0.56	0.56	0.56
Normal error correction	1.54	1.63	2.25	2.90
* Take4 mode used in conjunction with an HP Omnibook 5500CT laptop, 133 MHz pentium, running HP VEE 4.0 as program language.				

Programming Example

Basic programming example 2G is the complete execution of a two port error correction offloaded to an external PC.

The following is an outline of the programs' processing sequence:

- An I/O path is assigned for the analyzer. Bii mode is used for data transfers in order to get the fastest response.
- The system is initialized.
- The state of raw offsets is queried and turned off if they had been on.
- The analyzer is placed into local mode and the system operator is prompted to set up a 2-port calibration before continuing.
- The calibration coefficients are read from the analyzer into memory arrays.
- The calibration is turned off and the analyzer is placed into TAKE4 mode and HOLD mode.
- The operator is prompted to connect the DUT and select which S-parameter to send back to the analyzer.
- The currently displayed data is saved to the analyzer's internal memory to initialize the memory array.
- The analyzer is set up to display memory only and the default beep is turned off.
- The operator is prompted to press any key to terminate the program.
- A sweep is initiated and the main loop of the program begins

- After the sweep concludes' the four pre-raw S-parameters are read from the analyzer into an array in the computer.
- The error-corrected (calibrated) S-parameters are calculated using the pre-raw data and calibration coefficients.
- The calibrated data for the S-parameter selected earlier is sent into the analyzer and saved to the analyzer's internal memory.
- A new sweep is initiated and the loop repeats if there has been no keyboard activity.
- Upon exit of the loop, the analyzer is set up to display the active measurement trace.
- The analyzer's internal calibration is turned back on and continuous sweep mode is resumed.
- The analyzer is released from remote control and the program ends.

The program is written as follows:

```

1      ! This program demonstrates the TAKE4 mode.
2      ! The program first asks the user to set up the instrument
3      ! with a 2-port calibration.  The subroutine "Read_Cal_co"
4      ! is used to read the 12 term error correction arrays into
5      ! a (N x 12) 2-dimension array (N = number of points). This will
6      ! be used in the "Calc_2_port" subroutine.  The program turns off
7      ! error correction, puts the analyzer in hold, turns on TAKE4
a      ! mode, and starts a sweep.  The subroutine "Read_4_raw" reads in
9      ! the uncorrected data.  The subroutine "Cal_2_port" calculates
10     ! the error correction and returns the corrected arrays.
11     ! The corrected S-parameter is re-input to the analyzer, stored
12     ! in the memory trace and displayed in memory for a visual
13     ! indication of the take4 function.
14     !
15     ! EXAMP2E
16     !
17     !!!!!!!!!!!!!!!!!!!!!!!!!!!!!!!!!!!!!!!!!!!!!!!!!!!!!!!!!!!!!!!!!!!!!!!
1a    !
19     ! Initialize Arrays and Variables
20     !
21     !!!!!!!!!!!!!!!!!!!!!!!!!!!!!!!!!!!!!!!!!!!!!!!!!!!!!!!!!!!!!!!!!!!!!!!
22     !
23     INTEGER Hdr,Length
24     COMPLEX S11x,S21x,S12x,S22x,D
25     COMPLEX Calcoe(1:1601,1:12)      ! Cal Coefficients
26     COMPLEX S11r(1:1601)            ! Pre-Raw Data
27     COMPLEX S21r(1:1601)            ! Pre-Raw Data
28     COMPLEX S12r(1:1601)            ! Pre-Raw Data
29     COMPLEX S22r(1:1601)            ! Pre-Raw Data
30     COMPLEX S11a(1:1601)            ! Corrected Data
31     COMPLEX S21a(1:1601)            ! Corrected Data
32     COMPLEX S12a(1:1601)            ! Corrected Data
33     COMPLEX S22a(1:1601)            ! Corrected Data
34     !
35     ! Initialize output commands
36     !
37     DIM Out_cmd$(1:12)[10]
38     DATA "OUTPCALC01","OUTPCALC02","OUTPCALC03","OUTPCALC04"
39     DATA "OUTPCALC05","OUTPCALC06","OUTPCALC07","OUTPCALC08"

```

```

40 DATA "OUTPCALC09", "OUTPCALC10", "OUTPCALC11", "OUTPCALC12"
41 READ Out_cmd$(*)
42 !
43 ! Setup Network Analyzer
44 !
45 ASSIGN @Nwa TO 716 ! Assign an I/O path for the analyzer
46 ASSIGN @Nwdat TO 716;FORMAT OFF! Binary mode to read and write data
47 ABORT 7 ! Generate an IFC (Interface Clear)
48 CLEAR @Nwa ! SDC (Selected Device Clear) analyzer
49 CLEAR SCREEN
50 !
51 OUTPUT @Nwa;"RAWOFFS?;" ! Query whether raw offsets are on
52 ENTER @Nwa;I
53 IF I=1 THEN
54 PRINT "Raw offsets must be turned off prior to calibration."
55 PRINT "Turning them off now."
56 OUTPUT @Nwa;"RAWOFFSOFF;"
57 END IF
58 !
59 !
60 Check_for_cal: ! Turn on two-port cal, check and read
61 REPEAT
62 LOCAL @Nwa
63 INPUT "Set up a 2-port cal, hit return when ready",A
64 OUTPUT @Nwa;"CORR?;"
65 ENTER @Nwa;I
66 UNTIL I=1
67 !
68 ! Read the Calibration Coefficients
69 !
70 DISP "Reading in Calibration Coefficient Arrays: Please wait."
71 GOSUB Read_cal_co
72 !
73 ! Setup TAKE4 Bode,
74 !
75 OUTPUT @Nwa;"Corroff;take4on;hold;"
76 !
77 ! Choose an S-Parameter to send back to the Network Analyzer
78 !
79 REPEAT
80 INPUT "SELECT S-Parameter: 1=S11, 2=S21, 3=S12, 4=S22",Disp
81 SELECT Disp
82 CASE 1
83 Title$="S11"
84 Again=0
85 CASE 2
86 Title$="S21"
87 Again=0
88 CASE 3
89 Title$="S12"
90 Again=0
91 CASE 4
92 Title$="S22"
93 Again=0
94 CASE ELSE

```



```

95 Again=1
96 END SELECT
97 UNTIL Again=0
96 OUTPUT @Nwa;"TITL""&Title$&"";"
99 !
100 ! For this demonstration, we will return corrected values to the
101 ! memory trace. Therefore, display memory only
102 !
103 !!!!!!!!!!!!!!!!!!!!!!!!!!!!!!!!!!!!!!!!!!!!!!!!!!!!!!!!!!!!!!!!!!!!!!!
104 !
105 ! Note: Displaying MEMORY only inhibits the analyzer's data
106 ! processing. Raw, Data, and Formatted arrays are not
107 ! updated. PreRaw is good.
108 !
109 OUTPUT @Nwa;"DATI;DISPMEMO;BEEPDONEOFF;"
110 PRINT "PRESS ANY KEY TO STOP"
111 Time1=TIMEDATE
112 !
113 ! Take the first sweep
114 !
115 OUTPUT @Nwa;"OPC?;SWPSTART;"
116 Run=1
117 Count=0
118 !
119 ! Now keep looping until any key is pressed
120 !
121 Timefmt:IMAGE "Cycle: ",2D,5X," 2-port Cal: ",2D.DD,X,"secs, +
displayed: ",2D.DDD,X,"seconds."
122 ON KBD GOSUB Stop-running
123 REPEAT
124 Count=Count+1
125 ENTER @Nwa;Done ! Read the OPC from the SWPSTART Command
126 GOSUB Read_4_raw ! Read the four raw S-parameters
127 GOSUB Calc_2_port ! Calculate the Corrected S-parameters
128 Time2=TIMEDATE
129 OUTPUT @Nwa;"INPUDATA;" ! Input them into the data array
130 OUTPUT @Nwdat;Hdr,Length ! Data header, same as the cal coeff's
131 SELECT Disp
132 CASE 1
133 OUTPUT @Nwdat;S11a(*) ! Send corrected S11 data to analyzer OR
134 CASE 2 !
135 OUTPUT @Nwdat;S21a(*) ! Send corrected S21 data to analyzer OR
136 CASE 3 !
137 OUTPUT @Nwdat;S12a(*) ! Send corrected S12 data to analyzer OR
138 CASE 4
139 OUTPUT @Nwdat;S22a(*) ! Send corrected S22 data to analyzer
140 END SELECT
141 OUTPUT @Nwa;"DATI;" ! Put the data into memory
142 OUTPUT @Nwa;"OPC?;SWPSTART;"! and start another sweep
143 Time3=TIMEDATE
144 DISP USING Timefmt;Count,Time2-Time1,Time3-Time1
145 Time1=TIMEDATE
146 UNTIL Run=0
147 OUTPUT @Nwa;"DISPDATA;CORRON;CONT;"
148 ABORT 7

```

```

149 LOCAL ONwa
150 STOP
151 Stop-running:      ! Terminate program upon keyboard input
152 Run=0
153 OFF KBD
154 RETURN
155 Read_4_raw:      ! Read in the pre-row arrays
156 A$="OUTPPRE"
157 FOR B=1 TO 4
158 Out_cmd1$=A$&VAL$(B)&";"      ! Build up the OUTPPREXX commands
159 OUTPUT ONwa;Out_cmd1$
160 ENTER ONwdat;Hdr,Length      ! Read in the header
161 SELECT B
162      !
163      ! Now read in each raw array
164      !
165 CASE 1
166   ENTER ONwdat;S11r(*)
167 CASE 2
168   ENTER ONwdat;S21r(*)
169 CASE 3
170   ENTER ONwdat;S12r(*)
171 CASE 4
172   ENTER ONwdat;S22r(*)
173 END SELECT
174 NEXT B
175 RETURN
176 Read_cal_co:      ! This loops through 12 times, reading each cal.
177      ! coefficient. First set up the FORM
178 OUTPUT ONwa;"FORM3;HOLD;"
179 OUTPUT ONwa;"POIN?;"
180 ENTER ONwa;Numpoints
181      !
182      ! Redimension the Calcoe array according to the number of points
183      !
184 REDIM Calcoe(1:Numpoints,1:12)
185      !
186      ! Also redimension all the other arrays used here, as this
187      ! routine only runs once at setup.
188      !
189 REDIM S11a(1:Numpoints)
190 REDIM S21a(1:Numpoints)
191 REDIM S12a(1:Numpoints)
192 REDIM S22a(1:Numpoints)
193 REDIM S11r(1:Numpoints)
194 REDIM S21r(1:Numpoints)
195 REDIM S12r(1:Numpoints)
196 REDIM S22r(1:Numpoints)
197 FOR Cx=1 TO 12
198 OUTPUT ONwa;Out_cmd$(Cx)      ! OUTPCALCXC commands
199 ENTER ONwdat;Hdr,Length      ! Read the header using FORMAT OFF mode
200 FOR N=1 TO Numpoints
201   ENTER ONwdat;Calcoe(N,Cx) ! Read data using FORMAT OFF mode
202 NEXT N
203 NEXT Cx

```

```

204 |
205 RETURN
206 Calc_2_port: ! Perform 2 Port Calibration
207 FOR N=1 TO Numpoints
208 |
209 | ! First correct for crosstalk, directivity, and tracking
210 |
211 | ! Subtract Directivity, divide by tracking
212 S11x=(S11r(N)-Calcoe(N,1))/Calcoe(N,3)
213 |
214 | ! Subtract Crosstalk, divide by tracking
215 S21x=(S21r(N)-Calcoe(N,4))/Calcoe(N,6)
216 |
217 | ! Subtract Crosstalk, divide by tracking
218 S12x=(S12r(N)-Calcoe(N,10))/Calcoe(N,12)
219 |
220 | ! Subtract Directivity, divide by tracking
221 S22x=(S22r(N)-Calcoe(N,7))/Calcoe(N,9)
222 |
223 | ! Now calculate the common denominator
224 |
225 D=(1+S11x*Calcoe(N,2))*(1+S22x*Calcoe(N,8))-(S21x*S12x*Calcoe(N,5)*
226 Calcoe(N,11))
227 |
228 | ! Now calculate each S-parameter
229 |
230 S11a(N)=((S11x*(1+S22x*Calcoe(N,8)))-(S21x*S12x*Calcoe(N,5)))/D
231 S21a(N)=((1+S22x*(Calcoe(N,8)-Calcoe(N,5)))*(S21x))/D
232 S12a(N)=((1+S11x*(Calcoe(N,2)-Calcoe(N,11)))*(S12x))/D
233 S22a(N)=((S22x*(1+S11x*Calcoe(N,2)))-(S21x*S12x*Calcoe(N,11)))/D
234 NEXT N
235 RETURN
236 END

```

Running the Program

The **analyzer** is initialized and raw offsets are turned off. After the analyzer is placed in local mode, the operator is prompted to set up a Z-port calibration before continuing. The resulting calibration coefficients are read from the analyzer into memory arrays.

Next, the calibration is turned off and the analyzer is placed into **TAKE4** mode and HOLD mode. After being prompted to connect the DTJT, the operator selects which S-parameter to send back to the analyzer. The currently displayed data is saved to the analyzer's internal memory and the analyzer is set up to display memory only. The operator is prompted to press any key to terminate the program, a sweep is initiated and the main loop of the program begins

After the sweep concludes, the four pre-raw S-parameters are read from the analyzer into memory arrays. The error-corrected (calibrated) S-parameters are calculated and the calibrated data for the S-parameter selected earlier is read into the analyzer and saved to the analyzer's internal memory. A new sweep is initiated and the loop repeats if there has been no keyboard activity.

Upon exit of the loop, the analyzer is set up to display the active measurement trace. The analyzer's internal calibration is turned back on and continuous sweep mode is resumed before the program ends

Example 3: Measurement Data Transfer

There are two methods that can be used to read trace information from the analyzer:

- selectively, using the trace markers
- completely, using the trace-data array

If only specific information (such as a single point on the trace or the result of a marker search) is required, the marker output command can be used to read the information. If all of the trace data is required, see Examples **3B** through **3E** for examples of the various formats available.

Trace-Data Formats and Transfers

Refer to **Table 24**. This table shows the number of bytes required to transfer a **201-point** trace in the different formats. As you will see in the **first** example (**FORM 4**), ASCII data is the easiest to transfer, but the most time **consuming** due to the number of bytes in the trace. If you are using a PC-based controller, a more suitable format would be **FORM 5**. To use any trace data format other than **FORM 4** (ASCII data) requires some care in transferring the data to the computer. Data types must be matched to read the bytes from the analyzer directly in to the variable array. The computer must be told to stop formatting the incoming data and treat it as a binary-data transfer. All of the other data formats also have a four byte header to deal with. The **first** two bytes are the ASCII characters "**#A**" that indicate that a **fixed** length block transfer follows, and the next two bytes form an integer containing the number of bytes in the block to follow. The header must be read in to separate it from the rest of the block data that is to be mapped into an array. "Array-Data Formats," located earlier in this chapter, discusses the different types of formats and their compositions.

Data may **also** be transferred from several different locations in the trace-processing chain. These examples will illustrate formatted-data transfers, but other locations in the trace-data processing chains may be accessed. See Figure 1-3.

In this section, an example of each of the data formats will be shown for comparison. In general, **FORM 1** (internal binary format) should be used for traces that are not being utilized for data content. Calibration data that is being transferred to a file and back is good example. See Example **3D**.

Arrays which will be interpreted or processed within your program should be in **FORM 2, 3** or **5**, whichever is appropriate for your computer. Example **3C** shows how to transfer a trace in these formats.

In Examples **3B** and **3C**, the frequency counterpart of each data point in the array is also determined. Many applications generate a frequency and magnitude, or a phase array for the test results. Such data may be required for other data processing applications (such as comparing data from other measurements).

In Example **3B**, the frequency data is constructed from the frequency span information. Alternatively, it is possible to read the frequencies directly out of the instrument with the **OUTPLIML** command. **OUTPLIML** reports the limit-test results by transmitting the stimulus point tested, a number indicating the limit-test results, and then the upper and lower limits at that **stimulus** point (if available). The number indicating the limit results is a -1 for no test, 0 for fail, and 1 for pass. If there are no limits available, the analyzer transmits zeros. For this example, we delete the limit test information and keep the **stimulus** information.

In Example **3C**, the limit-test array is read into the controller and used to provide the values directly from the analyzer memory. Reading from the limit-test array is convenient, although it outputs the results in ASCII format (**form 4**), which may be slow. If there is no other way to obtain the frequency data, this transfer time may be acceptable. Frequency information becomes more difficult to determine when not using the linear sweep mode. Log-frequency

sweeps and list-frequency sweeps have quite different values for each data point. For these special cases, the additional time spent reading out the limit test results is an acceptable solution for obtaining the valid frequency information for each data point in the trace.

Example 3A: Data Transfer Using Markers

Note This program is stored as **EXAMP3A** on the "Programming Examples" disk received with the network analyzer.

Markers are the simplest form of trace-data transfer. A marker may be positioned using one of three methods:

- by a frequency location
- by an actual data point location
- by a trace-data value

In the following example, the marker is positioned on the trace's **maximum** value. Once positioned on the trace, the trace data at that point can be read into the controller. The marker data is always returned in FORM 4, ASCII format. Each number is sent as a **24-character** string. Characters can be digits, signs, or decimal points **All** characters should be separated by commas. In the case of markers, three numbers are sent. The display format determines the values of the marker responses. See **Table 1-4**, "Units as a Function of Display Format."

When using trace data, it is important to control the network analyzer's sweep function (and therefore the trace data) from the computer. Using the computer to control the instrument's sweep insures that the data you read into the controller is in a quiescent or steady state. It also insures that the measurement is complete.

The following is an outline of the program's processing sequence:

- An I/O path is assigned for the analyzer.
- The system is initialized.
- The selected frequency span is swept once.
- The marker is activated and placed on the maximum trace value.
- The three marker values are output to the controller and displayed.
- The instrument is returned to **local** control and the program ends

The program is written as follows:

```
10 ! This program takes a sweep on the analyzer and turns on a marker.
20 ! The marker is positioned on the trace maximum and the marker data
30 ! is output in ASCII format.
40 !
50 ! EXAMP3A
60 !
70 ASSIGN QNWa TO 716 ! Assign an I/O path for the analyzer
80 !
90 CLEAR SCREEN
100 ! Initialize the analyzer
110 ABORT 7 ! Generate an IFC (Interface Clear)
120 CLEAR QNWa ! SDC (Selective Device Clear)
130 OUTPUT QNWa;"OPC?;PRES;" ! Preset the analyzer and wait
140 ENTER QNWa;Reply ! Read in the 1 returned
```

```

150 !
160 OUTPUT @Nwa;"OPC?;SING"           ! Single sweep mode and wait
170 ENTER @Nwa;Reply                 ! Read 1 when sweep complete
180 !
190 OUTPUT @Nwa;"MARK1;"             ! Turn on marker 1
200 OUTPUT @Nwa;"SEAMAX;"           ! Find the maximum
210 !
220 OUTPUT @Nwa;"OUTPMARK;"         ! Request the current marker value
230 ENTER @Nwa;Value1,Value2,Stim    ! Read three marker values
240 !
250 ! Show the marker data received.
260 PRINT " Value 1", " Value 2", "   Stimulus (Hz)"
270 PRINT Value1,Value2,Stim         ! Print the received values
280 PRINT
290 PRINT " Compare the active marker block with the received values"
300 !
310 LOCAL @Nwa                       ! Release HP-IB control
320 END

```

Running the Program

Run the program. The analyzer is preset and a sweep is taken. Marker 1 is enabled and positioned on the largest value in the trace. The marker is output to the controller and printed on the controller display. The analyzer is returned to local control. Position the marker using the RPG or data-entry keys, and compare the displayed value on the analyzer with the value that was transmitted to the controller.

The three values returned to the controller are:

1. reflection, in **dB**
2. a non-significant value
3. the stimulus frequency at the maximum point

A non-significant value means that the analyzer returned a value that is meaningless in this data format.

Table 1-4, located in Chapter 1, provides an easy reference for the types of data returned with the various data-format operational modes.

Example 3B: Data Transfer Using FORM 4 (ASCII Transfer)

Note This program is stored as **EXAMP3B** on the “Programming Examples” disk received with the network analyzer.

This example shows you how to transfer a trace array from the analyzer using FORM 4, an ASCII data transfer.

Table 2-4. HP 8719D/20D/22D Network Analyzer Array-Data Formats

Format type	Type of Data	Bytes per Data Value	Bytes per point 2 data values	(201 pts) Bytes per trace	Total Bytes with header
FORM 1	Internal Binary	3	6	1206	1210
FORM 2	IEEE 32-bit Floating-Point	4	8	1608	1612
FORM 3	IEEE 64-bit Floating-Point	8	16	3216	3220
FORM 4	ASCII Numbers	24 (Typical)	50 (Typical)	10,050 (Typical)	10,050* (Typical)
FORM 5	PC-DOS 32-bit Floating-Point	4	8	1608	1612

*No header is used in FORM 4.

The next most common data transfer is to transfer a trace array from the analyzer. **Table 2-4** shows the relationship of the two values-per-point that are transferred to the analyzer. When FORM 4 is used, each number is sent as a **24-character** string, each character represented by a digit, sign, or decimal point. Each number is separated from the previous number with a comma. Since there are two numbers-per-point, a **201-point** transfer in FORM 4 takes 10,050 bytes. This form is useful only when input-data formatting is difficult with the instrument controller. Refer to **Table 24** for a comparison with the other formats.

An example of a simple data transfer using FORM 4 (ASCII data transfer) is shown in this program. A fairly common requirement is to create frequency-amplitude data pairs from the trace data. No frequency information is included with the trace data transfer, because the frequency data must be calculated. Relating the data from a linear frequency sweep to frequency can be done by querying the analyzer start frequency, the frequency span, and the number of points in the sweep. Given that information, the frequency of point N in a linear frequency sweep is:

$$F = \text{Start-frequency} + (N-1) \times \text{Span}/(\text{Points}-1)$$

Example **3B** illustrates this technique. It is a straight-forward solution for linear uniform sweeps. For other sweep types, frequency data is more difficult to construct and may best be read directly from the analyzer's limit-test array. See Example **3D** for an explanation of this technique.

The following is an outline of the program's processing sequence:

- An I/O path is assigned for the analyzer.
- The system is initialized.
- The trace-data array is **allocated**.
- The trace length is set to 11.

- The selected frequency span is swept once.
- The FORM 4, ASCII format is set.
- The formatted trace is read from the analyzer and displayed.
- The frequency increments between the points are calculated.
- The marker is activated and placed at the lowest frequency of the analyzer (50 MHz).
- The instrument is returned to local control and the program ends.

The program is written as follows:

```

10 ! This program shows an ASCII format trace data transfer using form 4.
20 ! The data is received as a string of ASCII characters, 24 characters
30 ! per data point and transferred into a real array in the controller. The
40 ! corresponding frequency data is calculated from the analyzer settings.
50 !
60 ! EXAMP3B
70 !
80 ASSIGN @Nwa TO 716 ! Assign an I/O path to the analyzer
90 !
100 CLEAR SCREEN
110 ! Initialize
120 ABORT 7 ! Generate an IFC (Interface Clear)
130 CLEAR @Nwa ! SDC (Selective Device Clear)
140 OUTPUT @Nwa;"OPC?;PRES;" ! Preset the analyzer
150 ENTER @Nwa;Reply ! Read the 1 when complete
160 !
170 ! Trace values are two elements per point, display format dependent
180 DIM Dat(1:11,1:2) ! Trace data array
190 !
200 OUTPUT @Nwa;"POIN 11;" ! Set trace length to 11 points
210 OUTPUT @Nwa;"OPC?;SING;" ! Single sweep mode and wait
220 ENTER @Nwa;Reply ! Read reply
230 !
240 OUTPUT @Nwa;"FORM4;" ! Set form 4 ASCII format
250 OUTPUT @Nwa;"OUTPFORM;" ! Send formatted trace to controller
260 ENTER @Nwa;Dat(*) ! Read in data array from analyzer
270 !
280 ! Now to calculate the frequency increments between points
290 OUTPUT @Nwa;"POIN?;" ! Read number of points in the trace
300 ENTER @Nwa;Num_points
310 OUTPUT @Nwa;"STAR?;" ! Read the start frequency
320 ENTER @Nwa;Startf
330 OUTPUT @Nwa;"SPAN?;" ! Read the span
340 ENTER @Nwa;Span
350 !
360 F_inc=Span/(Num_points-1) ! Calculate fixed frequency increment
370 !
380 PRINT "Point","Freq (MHz)"," Value 1"," Value 2"
390 IMAGE 3D,7X,5D.3D,3X,3D.4D,3X,3D.4D ! Formatting for controller display
400 !
410 FOR I=1 TO Num_points ! Loop through data points
420 Freq=Startf+(I-1)*F_inc ! Calculate frequency of data point
430 PRINT USING 390;I,Freq/1.E+6,Dat(I,1),Dat(I,2)! Print analyzer data
440 NEXT I

```



```

450 !
460 OUTPUT @Nwa;"MARKDISC;"           ! Discrete marker mode
470 OUTPUT @Nwa;"MARK1 3E+4;"        ! Position marker at 30 KHz
480 !
490 OUTPUT @Nwa;"OPC?;WAIT;"         ! Wait for the analyzer to finish
500 ENTER @Nwa;Reply                 ! Read the 1 when complete
510 LOCAL 7                           ! Release HP-IB control
520 !
530 PRINT
540 PRINT "Position the marker with the knob and compare the values"
550 !
560 END

```

Running the Program

Run the program and watch the controller console. The analyzer will perform an instrument preset. The program **will** then print out the data values received from the analyzer. The marker is activated and placed at the left-hand edge of the analyzer's display. Position the marker with the knob and compare the values read with the active marker with the results printed on the controller console. The data points should agree exactly. Keep in mind that no matter how many digits are displayed, the analyzer is specified to measure:

- magnitude to a resolution of 0.001 dB
- phase to a resolution of 0.01 degrees
- group delay to a resolution of 0.01 ps

Changing the display format will change the data sent with the OUTPFORM transfer. See **Table 2-4** for a list of the specific data that is provided with each format. The data from **OUTPFORM** reflects all the post processing such as:

- time domain
- Gating
- electrical delay
- trace math
- smoothing

Example 3C: Data Transfer Using Floating-Point Numbers

Note This program is stored as **EXAMP3C** on the "Programming Examples" disk received with the network analyzer.

This example program illustrates data transfer using FORM 3 in which data is transmitted in the floating-point formats. FORM 2 is nearly identical except for the IEEE **32-bit** format of 4 bytes-per-value. FORM 5 reverses the order of the bytes to conform with the PC conventions for **defining** a real number.

The block-data formats have a four-byte header. The **first** two bytes are the ASCII characters "#A" that indicate that a fixed-length block transfer follows, and the next two bytes form an integer containing the number of bytes in the block to follow. The header must be read in so that data order is maintained.

This transfer is more than twice as fast than a FORM 4 transfer. With the FORM 4 transfer, 10,050 bytes are sent (201 points x 2 values-per-point x 24 bytes-per-value). Using FORM 2 to transfer the data, only 1612 bytes are sent (201 points x 2 values-per-point x 4 bytes-per-value). See "Array-Data Formats" in Chapter 1.

The following is an outline of the program's processing sequence:

- An I/O path is assigned for the analyzer.
- The system is initialized.
- The integer variables are **defined** to contain the header information.
- The number of points in the trace is set to 11.
- The selected frequency span is swept once.
- Data-transfer format 3 is set.
- The headers are read from the trace.
- The array size is calculated and allocated.
- The trace data is read in and printed.
- The marker is activated and placed at the lowest frequency of the analyzer (50 MHz).
- The instrument is returned to local control and the program ends

The program is written as follows:

```
10 ! This program shows how to read in a data trace in IEEE 64 bit
20 ! format. The array header is used to determine the length of the
30 ! array and to allocate the array size.
40 !
50 ! Program Example 3C
60 !
70 CLEAR SCREEN
80 ! Initialize the analyzer
90 ASSIGN ONwa TO 716 ! Assign an I/O path for the analyzer
100 ASSIGN ONwadat TO 716;FORMAT OFF ! Binary data path definition
110 !
120 ABORT 7 ! Generate an IFC ( Interface Clear)
130 CLEAR ONwa ! SDC (Selected Device Clear)
140 OUTPUT ONwa;"OPC?;PRES;" ! Preset the analyzer and wait
150 ENTER ONwa;Reply ! Read the 1 when completed
```

```

160 !
170 INTEGER Dheader,Dlength           ! Integer variables for header info
180 Numpoints=11                       ! Number of points in the trace
190 OUTPUT @Nwa;"POIN";Numpoints;"    ! Set number of points in trace
200 !
210 ! Set up data transfer
220 OUTPUT @Nwa;"OPC?;SING"           ! Single sweep and wait
230 ENTER @Nwa;Reply                  ! Read the 1 when completed
240 !
250 OUTPUT @Nwa;"FORM3;"              ! Select form 3 format
260 OUTPUT @Nwa;"OUTPFORM;"          ! Send formatted output trace
270 !
280 ENTER @Nwadat;Dheader,Dlength     ! Read headers from trace data
290 !
300 ALLOCATE Dat(1:Dlength/16,1:2)    ! Use length to determine array size
310 ENTER @Nwadat;Dat(*)              ! Read in trace data
320 !
330 PRINT "Size of array ";Dlength/16;" elements"
340 PRINT "Number of bytes ";Dlength
350 !
360 ! Print out the data array
370 PRINT "Element","Value 1","      Value 2"
380 IMAGE 3D,6X,3D.6D,6X,3D.6D
390 FOR I=1 TO Numpoints               ! Loop through the data points
400   PRINT USING 380;I,Dat(I,1),Dat(I,2)
410 NEXT I
420 !
430 OUTPUT @Nwa;"MARKDISC;"           ! Discrete marker mode
440 OUTPUT @Nwa;"MARK1.3E+6;"        ! Position marker at 30 KHz
450 !
460 OUTPUT @Nwa;"OPC?;WAIT;"         ! Wait for the analyzer to finish
470 ENTER @Nwa;Reply                  ! Read the 1 when complete
480 LOCAL @Nwa                         ! Release HP-IB control
490 !
500 PRINT
510 PRINT "Position the marker with the knob and compare the values."
520 !
530 END

```

Running the Program

Run the program. The computer displays the number of elements and bytes associated with the transfer of the trace, as well as the first 10 data **points**. Position the marker and examine the data values. Compare the displayed values with the analyzer's marker values.

Example 3D: Data Transfer Using Frequency-Array Information

Note This program is stored as **EXAMP3D** on the “Programming Examples” disk received with the network analyzer.

Example 3C was used to read in the trace-data array. Example 3D explains how to use the limit-test array to read the corresponding frequency values for the completed trace array into the controller. The analyzer is set to sweep from its start frequency (50 MHz) to 200 MHz in log-frequency mode with the number of points in the trace set to 11. This makes it very difficult to compute the frequency-point spacing in the trace. The points are equally spaced across the trace, but not equally spaced in relation to frequency (because the frequency span is displayed in a logarithmic scale, as opposed to a linear scale). The limit-test data array may be read from the analyzer to provide the frequency values for each data point. Four values are read for each data point on the analyzer. The test results and limit values are not used in this example. Only the frequency values are used. This technique is an effective method of obtaining the non-linear frequency data from the analyzer display. The test data and frequencies are printed on the controller display and the marker is enabled to allow the operator to examine the actual locations on the analyzer display.

The following is an outline of the program’s processing sequence:

- An I/O path is assigned for the analyzer.
- The system is initialized.
- The integer variables for the header information are defined.
- The number of points in the trace is set to 11.
- The frequency span (50 MHz to 200 MHz) is selected.
- The log-frequency sweep is selected.
- The data-transfer format 3 is set.
- The headers are read from the trace.
- The array size is calculated and allocated.
- The trace data is read in.
- The limit-test array is calculated and allocated.
- The limit-line test array is read in.
- The table header is printed.
- The program cycles through the trace values.
- The trace data and frequency are printed.
- The discrete-marker mode is activated.
- The marker is activated and placed at the lowest frequency of the analyzer (50 MHz).
- The instrument is returned to local control and the program ends

The program is written as follows:

```
10 ! This program shows how to read in a trace and create the frequency
20 ! value associated with the trace data value. EXAMP3C is used to
30 ! read in the data from the analyzer. The start and stop
40 ! frequencies are set to provide two decades of log range. Log sweep
50 ! is set and the frequency data points are read from the limit test
60 ! array and displayed with the data points.
70 !
80 ! EXAMP3D
90 !
100 ASSIGN Qnwa TO 716 ! Assign an I/O path for the analyzer
110 ASSIGN Qnwadat TO 716;FORMAT OFF ! Binary path for data transfer
120 !
130 CLEAR SCREEN
140 ! Initialize the analyzer
150 ABORT 7 ! Generate an IFC ( Interface Clear)
160 CLEAR Qnwa ! SDC (Selective Device Clear)
170 OUTPUT Qnwa;"OPC?;PRES;" ! Preset the analyzer and wait
180 ENTER Qnwa;Reply ! Read the 1 when completed
190 !
200 INTEGER Dheader,Dlength ! Integer variables for header info
210 !
220 OUTPUT Qnwa;"POIN 11;" ! Set trace length to 11 points
230 OUTPUT Qnwa;"STAR 50.E+6;" ! Start frequency 50 MHz
240 OUTPUT Qnwa;"STOP 200.E+6;" ! Stop frequency 200 MHz
250 OUTPUT Qnwa;"LOGFREQ;" ! Set log frequency sweep
260 !
270 ! Set up data transfer
280 OUTPUT Qnwa;"OPC?;SING" ! Single sweep and wait
290 ENTER Qnwa;Reply ! Read the 1 when completed
300 !
310 OUTPUT Qnwa;"FORM3;" ! Select form 3 trace format
320 OUTPUT Qnwa;"OUTPFORM;" ! Output formatted trace
330 !
340 ENTER Qnwadat;Dheader,Dlength ! Read headers from trace data
350 !
360 ALLOCATE Dat(1:Dlength/16,1:2) ! Use length to determine array size
370 ENTER Qnwadat;Dat(*) ! Read in trace data
380 !
390 ! Create the corresponding frequency values for the array
400 !
410 ! Read the frequency values using the limit test array
420 ALLOCATE Freq(1:Dlength/16,1:4) ! Limit line results array
430 ! Limit line values are frequency, test results, upper and lower limits
440 !
450 OUTPUT Qnwa;"OUTPLIML;" ! Request limit line test results
460 ENTER Qnwa;Freq(*) ! Read 4 values per point
470 !
480 ! Display table of freq and data
490 !
500 PRINT " Freq (MHz)", "Mag (dB)" ! Print table header
510 FOR I=1 TO 11 ! Cycle through the trace values
520 Freqm=Freq(I,1)/1.E+6 ! Convert frequency to MHz
530 PRINT USING "4D.6D,9X,3D.3D";Freqm,Dat(I,1) ! Print trace data
```

```

540 NEXT I
550 !
560 ! Set up marker to examine frequency values
570 OUTPUT @Nwa;"MARKDISC;"           ! Discrete marker mode
580 OUTPUT @Nwa;"MARK1 10.E+6;"      ! Turn on marker and place at 10 MHz
590 !
600 OUTPUT @Nwa;"OPC?;WAIT;"         ! Wait for the analyzer to finish
610 ENTER @Nwa;Reply                 ! Read the 1 when complete
620 LOCAL @Nwa                       ! Release HP-IB control
630 PRINT                             ! Blank line
640 PRINT "Position marker and observe frequency point spacing"
650 !
660 END

```

Running the Program

Run the program. Observe the controller display. The corresponding frequency values are shown with the trace-data values. Position the marker and observe the relationship between the frequency values and the point spacing on the trace. Compare the trace-data values on the analyzer with those shown on the controller display.

Example 3E: Data Transfer Using FORM 1, Internal-Binary Format

Note This program is stored as **EXAMP3E** on the "Programming Examples" disk received with the network analyzer.

FORM 1 is used for rapid I/O transfer of analyzer data. It contains the least number of bytes-per-trace and does not require re-formatting in the analyzer. This format is more difficult to convert into a numeric array in the controller.

The following is an outline of the program's processing sequence:

- An I/O path is assigned for the analyzer.
- The system is initialized.
- The integer variables for the header information are defined.
- The string variable for the header is defined.
- The selected frequency span is swept once.
- The internal-binary format is selected.
- The error-corrected data is output from the analyzer.
- The two data-header characters and the two length bytes are read in.
- The string buffer is allocated for data.
- The trace data is read into the string buffer.
- The analyzer is restored to continuous-sweep mode and queried for command completion.
- The **instrument** is returned to local control and the program ends

The program is written as follows:

```
10 ! This program is an example of a form 1, internal format data
20 ! transfer. The data is stored in a string dimensioned to the
30 ! length of the data being transferred.
40 !
50 ! EXAMP3E
60 !
70 ASSIGN ONwa TO 716 ! Assign an I/O path for the analyzer
80 ASSIGN ONwa_bin TO 716;FORMAT OFF ! Binary path for data transfer
90 !
100 CLEAR SCREEN
110 ! Initialize the analyzer
120 ABORT 7 ! Send IFC Interface Clear
130 CLEAR ONwa ! SDC (Selective Device Clear)
140 OUTPUT ONwa;"OPC?;PRES;" ! Preset the analyzer and wait
150 ENTER ONwa;Reply ! Read the 1 when completed
160 !
170 INTEGER Length ! Header length 2 bytes
180 DIM Header$(2) ! Header string 2 bytes
190 !
200 OUTPUT ONwa;"OPC?;SING;" ! Single sweep and wait
210 ENTER ONwa;Reply ! Read the 1 when completed
220 !
230 OUTPUT ONwa;"FORM1;" ! Select internal binary format
```

```

240 OUTPUT @Nwa;"OUTPDATA;"           ! Output error corrected data
250 !
260 ! Read in the data header two characters and two bytes for length
270 ! "#, 2A"
280 ! # no early termination, terminate when ENTER is complete
290 ! 2A read two chars
300 !
310 ENTER @Nwa_bin USING "#,2A";Header$ ! Read header as 2 byte string
320 ENTER @Nwa_bin;Length              ! Read length as 2 byte integer
330 PRINT "Header ";Header$,"Array length";Length
340 !
350 ALLOCATE Data$[Length]             ! String buffer for data bytes
360 ! "+,-K" format statement
370 ! + EOI as a terminator LF is suppressed and read as data
380 ! -K All characters are read and not interpreted LF is included
390 ENTER @Nwa_bin USING "+,-K";Data$  ! Read trace into string array
400 !
410 PRINT "Number of bytes received ";LEN(Data$)
420 !
430 OUTPUT @Nwa;"CONT;"               ! Restore continuous sweep
440 OUTPUT @Nwa;"OPC?;WAIT;"         ! Wait for the analyzer to finish
450 ENTER @Nwa;Reply                  ! Read the 1 when complete
460 !
470 LOCAL @Nwa                        ! Release HP-IB control
480 END

```

Running the Program

The analyzer is initialized. The header and the number of bytes in the block transfer are printed on the controller display. Once the transfer is complete, the number of bytes in the data string is printed. Compare the two numbers to be sure that the transfer was completed.

Example 4: Measurement Process Synchronization

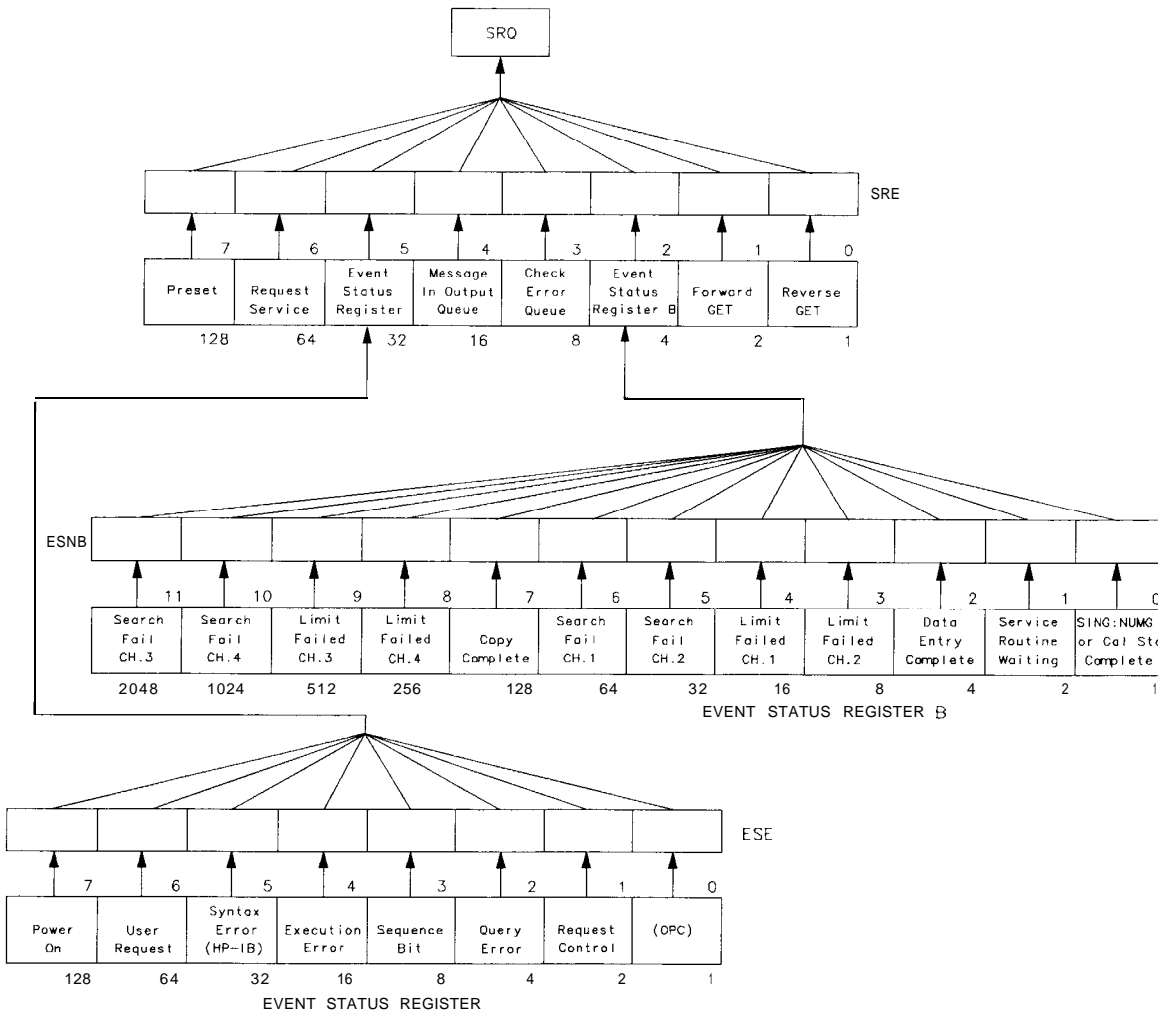

cb67d

Figure 2-2. Status Reporting Structure

Status Reporting

The analyzer has a status reporting mechanism, illustrated in Figure 2-2, that provides information about specific analyzer functions and events. The status byte is an **8-bit** register with each bit summarizing the state of one aspect of the instrument. For example, the error queue summary bit will always be set if there are any errors in the queue. The value of the status byte can be read with the **HP-IB** serial poll operation. This command does not **automatically** put the instrument in remote mode, which gives you access to the analyzer front-panel functions. The status byte can also be read by sending the command **OUTPSTAT**. Reading the status byte does not affect its value.

The status byte **summarizes** the error queue, as mentioned before. It also summarizes two event-status registers that monitor **specific** conditions inside the instrument. The status byte also has a bit (6) that is set when the instrument is issuing a service request over HP-IB,

and a bit (0) that is set in the event-status register when the analyzer has data to send out over HP-IB. See "Error Reporting," located in Chapter 1, for a discussion of the event-status registers.

Example 4A: Using the Error Queue

Note This program is stored as **EXAMP4A** on the "Programming Examples" disk received with the network analyzer.

The error queue holds up to 20 instrument errors and warnings in the order that they occurred. Each time the analyzer detects an error condition, the analyzer displays a message, and puts the error in the error queue. If there are any errors in the queue, bit 3 of the status byte will be set. The errors can be read from the queue with the OUTPERRO command. OUTPERRO causes the analyzer to transmit the error number and message of the oldest error in the queue.

The following is an outline of the program's processing sequence:

- An I/O path is assigned for the analyzer.
- The system is initialized.
- The error-message string is allocated.
- The analyzer is released from remote control.
- The program begins an endless loop to read the error queue.
- The status byte is read with a serial poll.
- The program tests to see if an error is present in the queue.
- The error-queue bit is set.
- The program requests the content of the error queue.
- The error number and string are read.
- The error messages are printed until there are no more errors in the queue.
- The instrument is returned to local control.
- The controller emits a beep to attract the attention of the operator and resumes searching for errors.

The program is written as follows:

```
10 ! This program is an example of using the error queue to detect
20 ! errors generated by the analyzer. The status byte is read and
30 ! bit 3 is tested to determine if an error exists. The error queue
40 ! is printed out and emptied.
50 !
60 ! EXAMP4A
70 !
80 ASSIGN ONwa TO 716 ! Assign an I/O path for the analyzer
90 !
100 CLEAR SCREEN
110 ! Initialize the analyzer
120 ABORT 7 ! Generate an IFC (Interface Clear)
130 CLEAR ONwa ! SDC (Selective Device Clear)
140 OUTPUT ONwa;"OPC?;PRES;" ! Preset the analyzer and wait
150 ENTER ONwa;Reply ! Read the 1 when complete
```

```

160 !
170 DIM Error$[50]           ! String for analyzer error message
180 !
190 LOCAL @Nwa               ! Release analyzer from remote control
200 !
210 LOOP                     ! Endless loop to read error queue
220   REPEAT
230     Stat=SPOLL(@Nwa)      ! Read status byte with serial poll
240   UNTIL BIT(Stat,3)      ! Test for error queue present
250   !
260   !           Error queue bit is set
270   REPEAT                 ! Loop until error number is 0
280     OUTPUT @Nwa;"OUTPERRO;" ! Request error queue contents
290     ENTER @Nwa;Err,Error$  ! Read error number and string
300     PRINT Err,Error$      ! Print error messages
310   UNTIL Err=0            ! No more errors in queue
320   !
330   LOCAL @Nwa             ! Release analyzer from remote
340   BEEP 600,.2           ! Beep to attract attention
350 END LOOP                 ! Repeat error search
360 !
370 END

```

Running the Program

Run the program. The analyzer goes through the preset cycle. Nothing will happen at **first**. The program is waiting for an error condition to activate the error queue. To cause an error, press a **blank softkey**. The message CAUTION: INVALID KEY will appear on the analyzer. The computer will beep and print out two error messages. The **first** line will be the invalid key error message, and the second line will be the NO ERRORS message. To clear the error queue, you can either loop until the NO ERRORS message is received, or until the bit in the status register is cleared. In this case, we wait until the status bit in the status register is clear. Note that while the program is running, the analyzer remains in the local mode and the front-panel keys may be accessed.

The error queue will hold up to 20 errors until **all** the errors are read out or the instrument is preset. It is important to clear the error queue whenever errors are detected. Otherwise, old errors may be mistakenly associated with the current instrument state.

Press **(System)** and then the unlabeled key several times quickly and watch the display. The number of errors observed should correspond to the number of times you pressed the key.

As another example, press **(Cal) CORRECTION ON**. A complete list of error messages and their descriptions **can** be found in "Error Messages" of the *HP 8719D/20D/22D Network Analyzer User's Guide*.

The program is in an **infinite** loop waiting for errors to occur. End the program by pressing **(Reset)** or **(Break)** on the controller keyboard.

Note Not all messages displayed by the analyzer are put in the error queue: operator prompts and cautions are not included.

Example 4B: Generating Interrupts

Note This program is stored as **EXAMP4B** on the "Programming Examples" disk received with the network analyzer.

It is also possible to generate interrupts using the status-reporting mechanism. The status-byte bits can be enabled to generate a service request (SRQ) when set. In turn, the instrument controller can be set up to generate an interrupt on the SRQ and respond to the condition which caused the SRQ.

To generate an SRQ, a bit in the status byte is enabled using the command **SREn**. A one (1) in a bit position enables that bit in the status byte. Hence, **SEE 8** enables an SRQ on bit 3, the check-error queue, since the decimal value 8 equals 00001000 in binary representation. Whenever an error is put into the error queue and bit 3 is set, the SRQ line is asserted, illuminating the (S) indicator in the HP-IB status block on the front panel of the analyzer. The only way to clear the SRQ is to disable bit 3, re-enable bit 3, or read out **all** the errors from the queue.

A bit in the event-status register can be enabled so that it is summarized by bit 5 of the status byte. If any enabled bit in the event-status register is set, bit 5 of the status byte will also be set. For example **ESE 66** enables bits 1 and 6 of the event-status register, since in binary, the decimal number 66 equals 01000010. Hence, whenever active control is requested or a front-panel key is pressed, bit 5 of the status byte **will** be set. Similarly, **ESNBn** enables bits in event-status register B so that they will be summarized by bit 2 in the status byte.

To generate an SRQ from an event-status register, enable the desired event-status register bit. Then enable the status byte to generate an SRQ. For instance, **ESE 32 ; SEE 32**; enables the syntax-error bit. When the syntax-error bit is set, the summary bit in the status byte will be set. This will, in turn, enable an **SRQ** on bit 5 of the status byte, the summary bit for the event-status register.

The following is an outline of the program's processing sequence:

- An I/O path is assigned for the analyzer.
- The system is **initialized**.
- The status registers are cleared.
- The event-status register bit 5 is enabled.
- The status-register bit 5 is enabled.
- The interrupt pointer is enabled and points to a subroutine.
- **Two** bad commands are set to the analyzer to generate errors
- The controller reads a serial-poll byte from **HP-IB** in the event of an interrupt.
- **The** program tests for an SRQ.
- If the SRQ is not generated by the analyzer, the subroutine stops and displays **SRQ FROM OTHERDEVICE**.
- If the **SRQ** was generated by the analyzer, the program reads the status byte and event-status register.
- If bit 5 in the event-status register is set, program prints: **SYNTAX ERROR FROM ANALYZER**.
- If bit 5 in the event-status register is **NOT** set, program prints: **SYNTAX ERROR BIT NOT SET**.
- The **SRQ** interrupt is re-enabled on the bus

- At the **finish**, the interrupt is deactivated.
- The analyzer is released from remote control and the program ends.

The program is written as follows:

```

10 ! This program is an example of using an SRQ based interrupt to
20 ! detect an error condition in the analyzer. In this example, a
30 ! syntax error is generated with an invalid command. The status byte
40 ! is read in and tested. The error queue is read, printed out and
50 ! then cleared.
60 !
70 ! EXAMP4B
80 !
90 ASSIGN @Nwa TO 716 ! Assign an I/O path for the analyzer
100 !
110 CLEAR SCREEN
120 ! Initialize the analyzer
130 ABORT 7 ! Generate and IFC (Interface Clear)
140 CLEAR @Nwa ! SDC (Selective Device Clear)
150 OUTPUT @Nwa;"OPC?;PRES;" ! Preset the analyzer and wait
160 ENTER @Nwa;Reply ! Read the one from the analyzer
170 !
180 DIM Error$[50] ! String for analyzer error message
190 ! Set up syntax error interrupt
200 OUTPUT @Nwa;"CLES;" ! Clear the status registers
210 !
220 ! Generate SRQ when bit 5 is set
230 OUTPUT @Nwa;"ESE 32;" ! Event status register bit 5 enabled
240 !
250 ! Generate bit 5 in status register when syntax error occurs
260 OUTPUT @Nwa;"SRE 32;" ! Status register bit 5 enabled
270 !
280 ! Setup the interrupt pointer to a subroutine
290 ON INTR 7 GOSUB Srq,det ! When interrupt occurs go to Srq,det
300 Stat=SPOLL(@Nwa) ! Clear any pending SRQs
310 ENABLE INTR 7;2 ! Set interrupt on HP-IB bit 2 (SRQ)
320 !
330 DISP 'Waiting for bad syntax"
340 WAIT 2 ! Pause for 2 seconds
350 !
360 OUTPUT @Nwa;"STIP 2GHZ;;" ! Send bad STOP command syntax
370 !
380 WAIT 2 ! Pause for 2 seconds
390 DISP "" ! Clear display line
400 GOTO Finish ! Exit program example
410 !
420 !***** Subroutines *****
430 !
440 Srq,det: ! SRQ handler
450 Stat=SPOLL(@Nwa) ! Read serial poll byte from HP-IB
460 PRINT "Stat from Serial Poll";Stat
470 IF BIT(Stat,6) THEN ! Test for SRQ
480 PRINT "SRQ received from analyzer"
490 ELSE ! No SRQ from analyzer
500 PRINT "SRQ from other device"

```

```

510 STOP ! Stop if not from analyzer
520 END IF
530 !
540 IF BIT(Stat,5) THEN ! Event status register bit set
550 PRINT "Event Status Register caused SRQ"
560 ELSE ! Some other bit set
570 PRINT "Some other bit caused the SRQ"
580 STOP ! Stop if bit not set
590 END IF
600 !
610 REPEAT
620 OUTPUT @Nwa;"OUTPERRO;" ! Read analyzer error queue
630 ENTER @Nwa;Err,Error$ ! Read error number and string
640 PRINT Err,Error$ ! Print error message
650 UNTIL Err=0 ! No more errors in queue
660 !
670 PRINT ! White space
680 ENABLE INTR 7;2 ! Re-enable SRQ interrupt on HP-IB
690 RETURN
700 !
710 !***** End Subroutines *****
720 !
730 Finish: ! End of program and exit
740 DISP "Finished"
750 OFF INTR 7 ! Turn off interrupt
760 LOCAL @Nwa ! Release HP-IB control
770 END

```

Running the Program

Run the program. The computer will preset the analyzer, then pause for a second or two. After pausing, the program sends an invalid command string "STIP 2 GHZ ; " to cause a syntax error. This command is intended to be "STOP 2 GHZ ; ". The computer will display a series of messages from the SRQ-handler routine. The analyzer will display CAUTION : SYNTAX ERROR and the incorrect command, pointing to the first character it did not understand.

The SRQ can be cleared by reading the event-status register and clearing the latched bit, or by clearing the enable registers with CLES. The syntax-error message on the analyzer display can only be cleared by the HP-ID Device Clear (DCL) message or Selected Device Clear (SDC) message. Device Clear is not commonly used because it clears every device on the bus. Selected Device Clear can be used to reset the input and output queue and the registers of a specific instrument on the bus. This will also clear all the interrupt **definitions**.

Example 4C: Power Meter Calibration

Note This program is stored as **EXAMP4C** on the “Programming Examples” disk received with the network analyzer.

For increased accuracy of the analyzer’s PORT 1-output power, a power meter calibration is available. This measurement-accuracy enhancement technique is described in “Optimizing Measurement Results” of the *HP 8719D/20D/22D Network Analyzer User’s Guide*. The example described will perform the sample and sweep calibration under HP-IB remote control.

The power meter is **usually** connected to PORT 1 for the forward measurements. Its address must be set correctly and it must be connected to the HP-IB. The power meter address can be set by pressing: (Local) **SET ADDRESSES ADDRESS P MTR/HP1B** and using the **↑** and **↓** keys or the numeric key pad to complete the process. The appropriate command must be selected for **the model number of power meter being used**. Press **POWER MTR: []** until the model being used is displayed between the brackets.

The correction factors for the power sensor are entered into the analyzer. **All** of these steps are explained in the “Optimizing Measurement Results” chapter of the *HP 8719D/20D/22D Network Analyzer User’s Guide*.

The number of readings-per-point must also be selected before starting. The number of points directly affects the measurement time of the calibration sequence. The power meter must be triggered and read by the analyzer for each trace point. Typically, two readings-per-point is considered appropriate. More than two readings-per-point could lead to unacceptable processing time.

To control a power meter calibration via HP-IB, the analyzer must be set to pass-control mode. The analyzer must step to the next point in the sweep and read the power present at the power meter sensor. For this operation to take place, the system controller must set up the measurement and then pass control to the **analyzer** to read each data point in the sweep. After reading the data point from the power meter, the analyzer passes control back to the system controller. The **analyzer** then sets up to measure the next point and again requests control from the system controller. This process continues until the analyzer signals that the entire sweep has been measured point-by-point.

The following is an outline of the program’s processing sequence:

- **An** I/O path is assigned for the analyzer.
- **The** system is initialized.
- The number of points in the trace is set.
- The number of readings-per-point is set.
- The frequency span is set.

Note *The frequency span of this example program must be modified in order to correspond to the frequency ranges of the HP 8719D/20D/22D.*

- The reference channel is measured.
- The power meter calibration array is allocated.
- The power meter model is chosen.
- **The** status registers are cleared.

- The request-control summary bit is enabled.
- The pass-control mode is enabled.
- A calibration sweep is taken to begin the sequence.
- The status byte is read until control is requested.
- The computer passes control to the analyzer.
- The display is cleared and the analyzer is set to talker/listener mode.
- The HP-IB interface status is read until control is returned.
- **The** program loops until all the points have been measured.
- The power meter calibration is enabled.
- The calibration data is output to the controller in FORM 4, ASCII format.
- The power meter-calibration factors are read into the controller.
- The analyzer is released from remote control and the program ends

The program is written as follows:

```

10 ! This routine does a power meter cal using pass control.
20 ! A measurement cycle takes place on each point of the trace. The
30 ! point is measured by the power meter and the measured value read
40 ! into the analyzer. The command TAKCS; arms this measurement mode.
50 ! The number of measurements is determined by the number of points in
60 ! the trace, the number of readings per point and an extra measurement
70 ! cycle to release the powr meter.
80 ! Control is passed to the analyzer, the point is measured and
90 ! the data is transferred to the analyzer. Control is passed back to
100 ! the controller and the cycle begins again. Serial poll is used to
110 ! read the status byte of the analyzer and test the logic.
120 ! The HP-IB interface status register is monitored to determine when
130 ! control is returned to the interface from the analyzer.
140 !
150 ! EXAMP4C
160 !
170 ASSIGN QNWa TO 716           ! Assign an I/O path for the analyzer
180 !
190 CLEAR SCREEN
200 ! Initialize the analyzer
210 ABORT 7                       ! Generate an IFC (Interface Clear)
220 CLEAR QNWa                 ! SDC (Selective Device Clear)
230 OUTPUT QNWa;"OPC?;PRES;"   ! Preset the analyzer and wait
240 ENTER QNWa;Reply          ! Read the 1 when complete
250 !
260 INTEGER Stat
270 !
280 ! Set up the analyzer parameters
290 Numpoints=11                ! Number of points in the trace
300 Numreads=2                 ! Number of readings per point
310 Startf=1.00E+8             ! Start frequency
320 Stopf=5.0E+8              ! Stop frequency
330 !
340 OUTPUT QNWa;"POIN";Numpoints;"   ! Set trace length to numpoints
350 OUTPUT QNWa;"NUMR";Numreads;"   ! Set number of readings per point

```



```

360 OUTPUT @Nwa;"STAR";Startf           ! Set start frequency
370 OUTPUT @Nwa;"STOP";Stopf           ! Set stop frequency
380 OUTPUT @Nwa;"MEASR;"                ! Measure the reference channel
390 !
400 ALLOCATE Pmcal(1:Numpoints)         ! Create power meter cal array
410 !
420 ! Store the original trace for comparison
430 OUTPUT @Nwa;"DATI;"
440 OUTPUT @Nwa;"DISPDATM;"
450 OUTPUT @Nwa;"AUTO;"
460 !
470 ! Select the power meter being used for cal
480 ! OUTPUT @Nwa;"POWM ON;"            ! Select 436A power meter
490 OUTPUT @Nwa;"POWMOFF;DEBUON;"      ! Select 437B/438A power meter
500 !
510 ! Set analyzer HP-IB, status regs to interrupt on pass control
520 OUTPUT @Nwa;"CLES;"                 ! Clear status registers
530 OUTPUT @Nwa;"ESE2;"                 ! Enable request control summary bit
540 OUTPUT @Nwa;"SRE32;"                ! SRQ on events status register
550 !
560 PRINT "Beginning Power Meter CAL"
570 OUTPUT @Nwa;"USEPASC;"              ! Enable pass control operation
580 OUTPUT @Nwa;"TAKCS;"                ! Take Cal Sweep
590 !
600 FOR I=1 TO Numpoints*Numreads+1     ! Points * Number of readings plus 1
610   ! Serial poll does not place analyzer in remote operation
620   ! and does not require the analyzer to process the command.
630   !
640   REPEAT                             ! Repeat until SRQ detected
650     Stat=SPOLL(@Nwa)                  ! Serial poll to read status byte
660     DISP "Stat ";Stat;" Waiting for request"
670   UNTIL BIT(Stat,6)                  ! SRQ detected for request control
680   OUTPUT @Nwa;"ESR?;"                ! Read status register to clear
690   ENTER @Nwa;Reply                   ! Read and discard register value
700   !
710   PRINT "Passing Control"             ! status read and passing control
720   PASS CONTROL @Nwa                  ! Pass control to analyzer
730   !
740   REPEAT
750     ! Read HP-IB interface state information register.
760     STATUS 7,6;Hpib                  ! Test HP-IB register for control
770     !
780     ! Reading the interface status register does not interact with the
790     ! analyzer. Bit 6 is set when control is returned.
800     !
810     DISP "Waiting for control"
820     UNTIL BIT(Hpib,6)                 ! Loop until control is returned
830   NEXT I
840 !
850 PRINT "Finished with Power meter Cal"
860 DISP ""                               ! Clear display message
870 !
880 OUTPUT @Nwa;"TALKLIST;"             ! Restore Talker/Listener operation
890 OUTPUT @Nwa;"CLES;"                 ! Clear and reset status byte operation
900 !

```

```

910 OUTPUT @Nwa;"PVMCONES;"           ! Power meter cal correct one sweep
920 OUTPUT @Nwa;"OPC?;WAIT;"         ! Wait for the analyzer to finish
930 ENTER @Nwa;Reply                 ! Read the 1 when complete
940 !
950 ! Read the power meter cal correction factors
960 OUTPUT @Nwa;"FORM4;"             ! ASCII data format to read cal data
970 OUTPUT @Nwa;"OUTPPMCAL1;"       ! Request the power meter cal factors
980 ENTER @Nwa;Pmcal(*)              ! Read the factors
990 !
1000! Display the power meter cal factors
1010 PRINT "Point","Factor"
1020 FOR I=1 TO Numpoints            ! Cycle throught the factors
1030 PRINT I,Pmcal(I)
1040 NEXT I
1050!
1060 LOCAL @Nwa                      ! Release HP-IB control
1070 END

```

Running the Program

The analyzer is preset and the power meter-calibration routine begins. The analyzer displays the message **"WAITING FOR HP-IB CONTROL"** when it is requesting control. The system controller display prints "Passing Control" when control is passed to the analyzer. The controller displays **"Waiting for request"** while the analyzer has control and is reading the power meter.

The interaction of the messages and the movement of the cursor allow observation of the calibration process. Once the calibration is complete, the analyzer displays **"POWER METER CAL IS COMPLETE"** and the system controller displays **"Finished with Power meter Cal"**.

The power meter-calibration mode (with one sweep of correction data) is enabled and the calibration is switched ON. At the completion of the program, talker/listener mode is restored, the event-status registers are cleared (to halt the status-byte interaction), the power meter correction factors are displayed, the sweep is placed in continuous-sweep mode, the analyzer is released from HP-IB control, and the program ends.

Example 5: Network Analyzer System Setups

Saving and Recalling Instrument States

Note The most efficient option for storing and recalling analyzer states is using the analyzer's internal registers to save the CAL data. Recalling these registers is the fastest solution to restoring analyzer setups. See "Printing, Plotting, or Saving Measurement Results" in the *HP 8719D/20D/22D Network Analyzer User's Guide* for detailed information on the analyzer's internal storage registers.

In the event that **all** the registers have been used, the internal disk drive is not used, or if internal memory limitations exist, then these external solutions become viable.

The purpose of this example is to demonstrate several programming options for storing and recalling entire instrument states over HP-IB. The examples describe two different processes for storing and recalling instrument states. The **first** example accomplishes the task using the learn string. The second example involves reading both the learn string and the calibration arrays out of the analyzer and storing them to disk or storing them in the system controller itself.

Using the learn string is a very rapid way of saving the instrument state, but using direct disk access has the advantage of **automatically** storing calibrations, **cal** kits, and data **along** with the instrument state.

A complete analyzer setup requires sending the learn string and a calibration array to set the analyzer parameters. The CAL array may **also** be placed in the analyzer, just as if a calibration was performed. By sending both sets of data, the analyzer may be quickly setup for a measurement.

Several different measurements may be required in the course of testing a device. An efficient way of performing multiple measurements is to send both the calibration array and the learn string, and then perform the measurements.

Example 5A: Using the Learn String

Note This program is stored as **EXAMP5A** on the "Programming Examples" disk received with the network analyzer.

The learn string is a very fast and easy way to read an **instrument** state. The learn string includes **all** front-panel settings, the limit table for each channel, and the list-frequency table. It can be read out of the **analyzer** with the command OUTPLEAS, and input to the analyzer with the command INPULEAS. The example for a **FORM 1** transfer could also have been used. However, Example **5A** is the simplest solution for reading the learn string from the analyzer.

The following is an outline of the program's processing sequence:

- An I/O path is assigned for the analyzer.
- **The** system is initialized.
- **The string** storage is allocated.
- The learn string is requested.
- The string is read without any processing.

- The analyzer is released from remote control.
- The instrument state is changed by the operator.
- The learn string is sent back to the analyzer.
- The analyzer is released from remote control and the program ends.

The program is written as follows:

```

10 ! This program shows how to retrieve a learn string from the analyzer
20 ! into a string array. The state of the analyzer is then changed and the
30 ! learn string re-loaded to return the analyzer to the previous settings.
40 !
50 ! EXAMP5A
60 !
70 ASSIGN QNWa TO 716 ! Assign an I/O path for the analyzer
80 !
90 CLEAR SCREEN
100 ! Initialize the analyzer
110 ABORT 7 ! Generate an IFC (Interface Clear)
120 CLEAR QNWa ! SDC (Selected Device Clear)
130 !
140 DIM State$[3000] ! Define a string for contents
150 !
160 OUTPUT QNWa;"OUTPLEAS;" ! Output the learn string
170 ENTER QNWa USING "+,-K";State$ ! Read the string with no processing
180 ! + Terminate on EOI only
190 ! -K ignore LF as terminator treat as data
200 !
210 LOCAL QNWa ! Release HP-IB control
220 !
230 INPUT "Change state and press ENTER",A$
240 !
250 OUTPUT QNWa;"INPULEAS;";State$; ! Send the learnstring to analyzer
260 DISP "Analyzer state has been restored!"
270 !
280 OUTPUT QNWa;"OPC?;WAIT;" ! Wait for the analyzer to finish
290 ENTER QNWa;Reply ! Read the 1 when complete
300 LOCAL QNWa ! Release BP-IB control
310 END

```

Running the Program

Run the program. When the program stops, change the instrument state and press **Enter** on the controller. The analyzer will be returned to its original state by using the learn string.

Example 5B: Reading Calibration Data

Note This program is stored as **EXAMP5B** on the “Programming Examples” disk received with the network analyzer.

This example demonstrates:

- how to read measurement calibration data out of the network analyzer
- how to read it back into the analyzer
- how to determine which calibration is active

The data used to perform measurement-error correction is stored inside the analyzer in one (or more) of twelve calibration-coefficient arrays. Each array is a specific error coefficient, and is stored and transmitted as an error-corrected data array. Each point is a real/imaginary pair, and the number of points in the array is the same as the number of points in the sweep. The five data formats also apply to the transfer of calibration-coefficient arrays. “Printing, Plotting, or Saving Measurement Results” in the *HP 8719D/20D/22D Network Analyzer User’s Guide* contains information on the storage locations for calibration coefficients and different calibration types.

A computer can read out the error coefficients using the commands **OUTPCALC01**, **OUTPCALC02**, . . . through **OUTPCALC12**. Each calibration type uses only as many arrays as required, beginning with array 1. Hence, it is necessary to know the type of calibration about to be read out: attempting to read an array not being used in the current calibration causes the **“REQUESTED DATA NOT CURRENTLY AVAILABLE” warning**.

A computer can also store calibration coefficients in the analyzer. To do this, declare the type of calibration data about to be stored in the analyzer just as if you were about to perform that calibration. Then, instead of calling up different classes, transfer the calibration coefficients using the **INPUCALCnn**; commands. The variables **nn** are a data pair appended to the command representing a calibration number from 01 through 12. When all the coefficients are stored in the analyzer, activate the calibration by issuing the mnemonic **SAVC ;**, and trigger a sweep on the analyzer.

This example reads the calibration coefficients into a very large array, from which they can be examined, modified, stored, or put back into the instrument. If the data is to be directly stored on to disk, it is usually more efficient to use **FORM 1** (analyzer’s internal-binary format), and to store each coefficient array as it is read in.

The following is an outline of the program’s processing sequence:

- An I/O path is assigned for the analyzer.
- A binary path is assigned.
- The system is initialized.
- The calibration types and number of arrays are **defined**.
- The integer variables for reading the headers are defined.
- The calibration type and number of arrays are read by the controller.
- The output is formatted in **FORM 3**.
- The number of points in the trace is read.
- The memory is allocated for the calibration arrays
- Each calibration array is requested from the analyzer.
- Header information is read with a binary **I/O** path.

- The elements from each calibration array are read in.
- The next calibration array is requested until all the arrays have been read.
- The **calibration type** is sent to the analyzer.
- Each calibration **array** is sent.
- The calibration is activated.
- The analyzer is released from remote control and the program ends.

The program is written as follows:

```

10 ! This program shows how to manipulate calibration data from the analyzer.
20 ! It demonstrates how to read calibration data from the analyzer, and
30 ! how to replace it. The type of calibration active is determined and
40 ! the program reads in the correct number of arrays. The number of points
50 ! in the trace, and in the cal array, is determined and used to dimension
60 ! storage arrays.
70 !
80 ! EXAMP5B
90 !
100 ASSIGN ONwa TO 716 ! Assign an I/O path for the analyzer
110 ASSIGN ONwa_bin TO 716;FORMAT OFF ! Assign binary path
120 !
130 CLEAR SCREEN
140 ! Initialize the analyzer
150 ABORT 7 ! Generate an IFC (Interface Clear)
160 CLEAR ONwa ! SDC (Selected Device Clear)
170 !
180 ! Data for determining CAL type and number of arrays
190 DATA "CALIRESP",1,"CALIRAI",2,"CALIS111",3
200 DATA "CALIS221",3,"CALIFUL2",12
210 DATA "NOOP",0
220 !
230 INTEGER Hdr,Lgth,I,J ! Integers for reading headers
240 !
250 READ Cal$,Numb ! Read CAL type from data statement
260 IF Numb=0 THEN GOTO 690 ! If no CAL type is present Exit
270 OUTPUT ONwa;Cal$;"?;" ! Query if CAL type is active
280 ENTER ONwa;Active ! Read 1 if active
290 IF NOT Active THEN GOTO 250 ! Load another CAL type and re-try
300 !
310 PRINT Cal$,Numb ! Active CAL and number of arrays
320 !
330 OUTPUT ONwa;"FORM3;" ! Form 3 IEEE 64 bit floating point
340 OUTPUT ONwa;"POIN?;" ! Request trace length
350 ENTER ONwa;Poin ! Read number of points
360 ALLOCATE Cal(1:Numb,1:Poin,1:2) ! Arrays for CAL arrays
370 ! Number of arrays, number of points real and imag value per point
380 !
390 FOR I=1 TO Numb ! Read arrays
400 OUTPUT ONwa USING "K,ZZ";"OUTPCALC",I ! Format I to add 0 in command
410 ENTER ONwa_bin;Hdr,Lgth ! Read header & length from array
420 FOR J=1 TO Poin ! Read elements for CAL array
430 ENTER ONwa_bin;Cal(I,J,1),Cal(I,J,2) ! Read real & imag pair elements
440 NEKTJ ! Next location in array

```

```

450 NEXT I                                ! Next CAL array
460 !
470 ! All CAL arrays have been read
480 !
490 INPUT "PRESS RETURN TO RE-TRANSMIT CALIBRATION",Dum$
500 !
510 OUTPUT @Nwa;"FORM3;"                  ! Use same format as read
520 OUTPUT @Nwa;Calt$;";"                ! Send CAL type to analyzer
530 !
540 FOR I=1 TO Numb                        ! Send each array in CAL
550   DISP "TRANSMITTING ARRAY: ",I       ! Show array number
560   OUTPUT @Nwa USING "K,ZZ";"INPUCALC",I ! Send array number 0 format
570   OUTPUT @Nwa_bin;Hdr,Lgth           ! Send header & array length
580   FOR J=1 TO Poin                     ! Send each array element
590     OUTPUT @Nwa_bin;Cal(I,J,1),Cal(I,J,2) ! Real and Imag pair
600   NEXT J                              ! Next element in array
610 NEXT I                                ! Next array
620 !
630 OUTPUT @Nwa;"SAVC;"                   ! Activate CAL
640 !
650 OUTPUT @Nwa;"CONT;"                   ! Restore continuous sweep
660 OUTPUT @Nwa;"OPC?;WAIT;"             ! Wait for analyzer to finish
670 ENTER @Nwa;Reply                       ! Read the 1 when complete
680 !
690 DISP "Finished with CAL transfer"
700 LOCAL @Nwa                             ! Release HP-IB control
710 END

```

Running the Program

Before executing the program, perform a calibration.

The program is able to detect which type of calibration is active. With that information, it predicts how many arrays to read out. When **all** the arrays have been sent to the computer, the program prompts the user. The operator then turns the calibration OFF or performs a completely different calibration on the analyzer and continues the program. The computer reloads the old calibration. The operator should not preset the analyzer because the instrument settings must be the same as those that were present when the calibration was taken.

Note The retransmitted calibration is associated with the current instrument state: the instrument has no way of knowing the original state associated with the calibration data. For this reason, it is recommended that the learn string be used to store the instrument state whenever calibration data is stored. The next example demonstrates how to reload the analyzer state with both the learn string and the calibration arrays

Example 5C: Saving and Restoring the Analyzer Instrument State

Note This program is stored as **EXAMP5C** on the “Programming Examples” disk received with the network analyzer.

Note The instrument state may also be stored in the analyzer’s internal registers. This is the fastest and most efficient method for toggling between instrument states. This example is for use when the analyzer’s internal memory is full, or when there are other internal-memory limitations.

This example demonstrates using both the learn string and the calibration arrays to completely re-program the analyzer state. If you were performing two entirely different measurements on a device and wanted to quickly change between instrument states and perform the measurements, this example program is a potential solution.

The example will request the learn string and calibration array from the analyzer and store them in a disk file on the system controller. Once the storage is complete, the operator will be prompted to change the state of the analyzer and then re-load the state that was previously stored in the disk **file**. Once the file is created on the disk, the state information can be retrieved from the controller and restored on the analyzer.

Note The disk **file** can only be created once. Errors will occur if the operator repeatedly tries to re-create the **file**.

For this example, only a thru calibration will be performed and transferred. This means only one calibration array will be read from the analyzer and written to the disk **file** with the instrument state. To work with more elaborate calibrations, additional arrays will need to be **defined** and transferred to the disk **file**. This is not difficult, but requires some further programming steps which were omitted in the interest of presenting a simple example.

The following is an outline of the program’s processing sequence:

- An I/O path is assigned for the analyzer.
- A binary path is assigned.
- The integers for reading the headers are defined.
- The system is initialized.
- An array is created to hold the learn string.
- The learn string is requested by the controller.
- The number of points in the trace is read.
- The controller allocates an array for the calibration data.
- The calibration data is read into the controller.
- The controller creates and assigns a data **file** for the calibration array and the learn string.
- The learn string and calibration array are stored in the disk **file**.
- The operator presses **(Enter)** on the controller to read the calibration data back into the analyzer.
- The learn string is read from the disk **file** and output to the analyzer.
- The calibration array is read in from the disk **file** and stored in the analyzer.

- The analyzer is returned to continuous-sweep mode.
- The analyzer is released from remote control and the program ends.

The program is written as follows:

```

10 ! This program reads an instrument state and stores it in a disk file.
20 ! The learn string and CAL array are both read into the controller and
30 ! then transferred to a disk file for storage. The file contents are
40 ! then restored to the analyzer. The analyzer is preset to the default
50 ! settings before the instrument state is transferred back.
60 !
70 ! EXAMP5C
80 !
90 ASSIGN @Nwa TO 716 ! Assign an I/O path for the analyzer
100 ASSIGN @Nwa_bin TO 716;FORMAT OFF ! Assign a binary path
110 !
120 INTEGER Head,Length ! Integer 2 byte format for headers
130 !
140 CLEAR SCREEN
150 ! Initialize the analyzer
160 ABORT 7 ! Generate an IFC (Interface Clear)
170 CLEAR @Nwa ! SDC (Selected Device Clear)
180 !
190 ! Read in the learn string as a form 1 binary data trace
200 DIM Learn$[3000] ! Array to hold learn string
210 !
220 OUTPUT @Nwa;"OPC?;SING;" ! Place analyzer in single sweep
230 ENTER @Nwa;Reply ! Read the 1 when complete
240 !
250 OUTPUT @Nwa;"OUTPLEAS;" ! Request learn string
260 ENTER @Nwa USING "+,-K";Learn$
270 !
280 ! Allocate an array for storing the CAL data
290 OUTPUT @Nwa;"POIN?;" ! Find number of points in trace
300 ENTER @Nwa;Num_points ! Read number to allocate array
310 ALLOCATE Cal_array(1:Num_points,1:2) ! Real and Imag for each point
320 !
330 ! Read Cal array
340 OUTPUT @Nwa;"FORM3;" ! Form 3 64 bit floating point data
350 OUTPUT @Nwa;"OUTPCALC01;" ! Request the cal array
360 !
370 ! Read the #A and 2 byte length as integers
380 ENTER @Nwa_bin;Head,Length,Cal_array(*) ! Read cal array data
390 !
400 ! Write instrument state data to disk file
410 ! CREATE BDAT "DATA_FILE: ,1406",1,Length+3000 ! Create data file once!
420 ASSIGN @File TO "DATA_FILE: ,1406 " ! Assign I/O path to file
430 OUTPUT @File;Learn$ ! Send learn string to disk file
440 OUTPUT @File;Head,Length,Cal_array(*) ! Send CAL arrays to disk file
450 ASSIGN @File TO * ! Close file
460 !
470 INPUT "Cal data received. Press ENTER to send it back.",A$
480 !
490 ! Read arrays from file
500 !

```

```

510 DIM Learn2$[3000]           ! String for learn string storage
520 ASSIGN @File TO "DATA_FILE: ,1406" ! Open file for reading arrays
530 ENTER @File;Learn2$       ! Read learn string from file
540 !
550 ENTER @File;Head,Length   ! Read CAL data headers from file
560 Size=Length/16           ! Array is 2 numbers, 8 bytes per number
570 ALLOCATE Cal_array2(1:Size,1:2) ! new cal array from file record
580 ENTER @File;Cal_array2(*) ! Read cal array from disk file
590 !
600 ! Send Learn string back
610 OUTPUT @Nwa;"INPULEAS;" ,Learn2$ ! Send learn string array
620 !
630 ! Send Cal array back
640 OUTPUT @Nwa;"CALIRESP;"      ! Send CAL type (Response)
650 OUTPUT @Nwa;"INPUCALCO1;"   ! Output CAL array to analyzer
660 OUTPUT @Nwa_bin;Head,Length,Cal_array2(*)
670 OUTPUT @Nwa;"OPC?;SAVC;"    ! Save the CAL array
680 ENTER @Nwa;Reply           ! Read the 1 when complete
690 !
700 OUTPUT @Nwa;" ; CONT;"      ! Start the analyzer sweeping
710 OUTPUT @Nwa;"OPC?;WAIT;"    ! Wait for the analyzer to finish
720 ENTER @Nwa;Reply
730 LOCAL @Nwa                ! Release HP-IB control
740 END

```

Running the Program

Setup the analyzer and perform a thorough calibration.

Run the program. The program prompts the operator to change the state of the analyzer and then press **Enter** to continue. At this point, the analyzer state is stored on the disk file in the controller. Pressing **Enter** will begin the transfer from the disk **file** to internal arrays within the controller and then on to the analyzer.

Once completed:

- The original state will be restored.
- **The** analyzer will be sweeping.
- The analyzer will be calibrated.
- COR will be displayed on the analyzer's display.

Example 6: Limit-Line Testing

Using List-Frequency Mode

The analyzer normally takes data points spaced at regular intervals across the overall frequency range of the measurement. For example, for a 2 GHz frequency span using 201 points, data will be taken at intervals of 10 MHz. The list-frequency mode **allows** the operator to select the specific points, or frequency spacing between points, at which measurements are to be made. This mode of operation allows flexibility in setting up tests that insure device performance in an efficient manner. By only sampling specific points, measurement time is reduced. List-frequency sweeps are also discussed in “Application and Operation Concepts” of the *HP 8719D/20D/22D Network Analyzer User’s Guide*. These programs emulate operation from the analyzer’s front panel when using list sweeps.

The following two examples illustrate the use of the analyzer’s list-frequency mode to perform arbitrary frequency testing. Example **6A** allows the operator to construct a table of list-frequency segments which is then loaded into the analyzer’s list-frequency table. There are a maximum of 30 segments available. Each segment stipulates a start and stop frequency, and the number of data points to be taken over that frequency range. Example **6B** lets the operator select a **specific** segment to “zoom-in.” A single instrument can be programmed to measure several different devices, each with its own frequency range, using a single calibration. When a **specific** device is connected, the operator selects the appropriate segment for that device. Note that list-frequency segments can be overlapped, but the total number of points in all the segments must not exceed 1632.

Example 6A: Setting Up a List-Frequency Sweep

Note This program is stored as **EXAMP6A** on the “Programming Examples” disk received with the network analyzer.

The purpose of this example is to show how to create a list-frequency table and transmit it to the analyzer.

The command sequence for entering a list-frequency table imitates the key sequence followed when entering a table from the front panel: there is a command for every key-press

Editing a segment is also the same as the front-panel key sequence, but remember the analyzer automatically reorders each edited segment in order of increasing start frequency.

The list-frequency table is also carried as part of the learn string. While the table cannot be modified as part of the learn string, it can be stored and recalled with very little effort by storing and recalling the learn string. See “Data Processing Chain” in Chapter 1 for details on using learn strings

This example takes advantage of the computer’s capabilities to simplify:

- creating a list-frequency table
- editing a list-frequency table

The table is entered and completely edited before being transmitted to the analyzer. ‘lb simplify the programming task, options such as entering center frequency, frequency span, or step size are not included.

The list-frequency information may be acquired using the limit-test results array. The actual **stimulus** points are available as the **first** element in the array.

The following is an outline of the program's processing sequence:

- An I/O path is assigned for the analyzer.
- The system is initialized.
- The existing **list** frequencies are edited and cleared.
- The number of segments to define is read in.
- An array for the **list** segments is **defined**.
- The parameters for each segment are requested.
- If the operator wants to edit, the segment parameters are re-entered.
- **The** new list is sent to the analyzer.
- The analyzer is released from remote control and the program ends

The program is written as **follows**:

```
10 ! This program shows how to enter and edit a list frequency table.
20 ! Any existing table is deleted and a new table is defined and
30 ! edited. This list is then sent to the analyzer. Any number of
40 ! segments or points may be entered. Be sure not to enter more than
50 ! 1632 points or 30 segments.
60 !
70 ! EXAMP6A
80 !
90 ASSIGN Qnwa TO 716 ! Assign an I/O path for the analyzer
100 !
110 CLEAR SCREEN
120 ! Initialize the analyzer
130 ABORT 7 ! Generate an IFC (Interface Clear)
140 CLEAR Qnwa ! SDC (Selective Device Clear)
150 OUTPUT Qnwa; "OPC?;PRES;" ! Preset the analyzer and wait
160 ENTER Qnwa; Reply ! Read the 1 when complete
170 !
180 OUTPUT Qnwa; "EDITLIST;" ! Begin editing the frequency list
190 OUTPUT Qnwa; "CLEL;" ! Clear the existing list frequencies
200 !
210 INPUT "Number of segments?", Numb ! Read number of segments to define
220 ALLOCATE Table(1:Numb,1:3) ! Define an array for the list segments
230 !
240 PRINT USING "10A,15A,15A,20A"; "SEGMENT", "START(MHZ)", "STOP(MHZ)", "NUMBER OF
POINTS"
250 !
260 FOR I=1 TO Numb ! Cycle through the segments and read in the values
270 GOSUB Loadpoin
280 NEXT I
290 !
300 LOOP
310 INPUT "DO YOU WANT TO EDIT? Y OR N", An$
320 EXIT IF An$="N"
330 INPUT "ENTRY NUMBER?", I ! Get an entry number
340 GOSUB Loadpoin ! Go load point
350 END LOOP
360 !
370 OUTPUT Qnwa; "EDITLIST" ! Send the new list to the analyzer
```

```

380 FOR I=1 TO Numb           ! Send one segment at a time
390   OUTPUT @Nwa;"SADD;"    ! Add a segment
400   OUTPUT @Nwa;"STAR";Table(I,1);"MHZ;" ! Start frequency
410   OUTPUT @Nwa;"STOP";Table(I,2);"MHZ;" ! Stop frequency
420   OUTPUT @Nwa;"POIN",Table(I,3),";"    ! Number of points
430   OUTPUT @Nwa;"SDON;"      ! Segment done
440 NEXT I                   ! Next segment to send to the analyzer
450 !
460 OUTPUT @Nwa;"EDITDONE;"  ! Done with list
470 OUTPUT @Nwa;"LISFREQ;"    ! Set list frequency mode
480 !
490 OUTPUT @Nwa;"OPC?;WAIT;" ! Wait for analyzer to finish
500 ENTER @Nwa;Reply         ! Read the 1 when complete
510 LOCAL @Nwa               ! Release HP-IB control
520 STOP                     ! End of main program
530 !
540 ! *****Subroutines *****
550 !
560 Loadpoin:                ! Sub to read in each segment value
570 INPUT "START FREQUENCY? (MHZ)",Table(I,1) ! Read start frequency
580 INPUT "STOP FREQUENCY? (MHZ)",Table(I,2) ! Read stop frequency
590 INPUT "NUMBER OF POINTS?",Table(I,3)     ! Read number of points in seg
600 IF Table(I,3)=1 THEN Table(I,2)=Table(I,1) ! Single point same start stop
610 !
620 ! Print new segment into table on display
630 PRINT TABXY(0,I+1);I;TAB(10);Table(I,1);TAB(25);
640 PRINT Table(I,2);TAB(40),Table(I,3)
650 RETURN
660 END

```

Running the Program

Caution This example program will delete any existing limit lines before entering the new limits. If this is not desired, omit the line(s) that clear the existing limits (in this case, the command CLEL ; contained in **LINE** 190). This program begins by presetting the analyzer. The programmer will have to add the necessary command lines to set the analyzer to the specific operating conditions required for testing. The example program will show the limit lines defined, but the limits will always fail without additional analyzer setup.

The program displays the frequency-list table as it is entered. During editing, the displayed table is updated as each line is edited. The table is not re-ordered. At the completion of editing, the table is entered into the analyzer, and list-frequency mode is switched ON. During editing, pressing **(Enter)** leaves an entry at the old value.

If the analyzer display is within the range of the segments entered, then the number of points-per-segment may be observed on the analyzer's display.

Activate a marker and select the discrete-marker mode to observe the point spacing. Use an exaggerated scale with just a few points to **find** the list-frequency spacing between points

Example 6B: Selecting a Single Segment from a Table of Segments

Note This program is stored as **EXAMP6B** on the “Programming Examples” disk received with the network analyzer.

This example program demonstrates how to **define** a single segment as the operating-frequency range of the analyzer from a table of segments stored in the controller. The program assumes that a list-frequency table has already been entered into the analyzer, either manually, or using the program in Example 6A, “Setting Up a List-Frequency Sweep.”

The program **first** loads the list-frequency table into the computer by reading the start and stop frequencies of each segment and the number of points for each segment. The segment’s parameters are then displayed on the computer screen, and the operator can choose which segment is to be used by the analyzer. Note that only one segment can be chosen at a time.

The following is an outline of the program’s processing sequence:

- An I/O path is assigned for the analyzer.
- The system is initialized.
- The list-frequency segment is edited.
- The largest segment number is set.
- The highest segment number is requested.
- The number of actual segments is read in.
- A list-frequency table is **defined** and the segments are read in to the controller from the analyzer.
- The operator selects one of the segments of the sweep.
- **The** controller “zooms-in” and sweeps the **defined** segment.
- The operator ends the program by entering segment number **0**.
- The analyzer returns to sweeping all the segments in the table.
- The activation loop is ended and the program **ends**.

The program is written as follows:

```
10 ! This program shows how to select a single segment from a list
20 ! frequency sweep and activate it as the sweep. The list frequency
30 ! table is read from the analyzer and displayed on the computer
40 ! screen. The operator is prompted to select a segment and the
50 ! program then activates it. All the segments are activated upon
60 ! completion.
70 !
80 ! EXAMP6B
90 !
100 ASSIGN ONwa TO 716 ! Assign an I/O path for the analyzer
110 !
120 CLEAR SCREEN
130 ! Initialize the analyzer
140 ABORT 7 ! Generate an IFC (Interface Clear)
150 CLEAR ONwa ! SDC (Selected Device Clear)
160 !
170 ! Print header for table of existing segments
```

```

180 PRINT USING "10A,15A,15A,20A";"SEGMENT","START(MHZ)","STOP(MHZ)","NUMBER OF
    POINTS"
190 OUTPUT @Nwa;"EDITLIST;"          ! Edit list frequency segment
200 OUTPUT @Nwa;"SEDI30;"           ! Set largest segment number
210 OUTPUT @Nwa;"SEDI?;"           ! Request number of highest segment
220 ENTER @Nwa;Numsegs             ! Read number of actual segments
230 !
240 ! Setup table and read segments from analyzer
250 ALLOCATE Table(1:Numsegs,1:3)   ! Allocate table of segments
260 FOR I=1 TO Numsegs              ! Cycle through segments
270   GOSUB Readlist                ! Read in segment definitions
280 NEXT I                          ! Next segment
290 !
300 ! Loop and read segment to be activated
310 LOOP                            ! Request operator to enter segment
320   INPUT "SELECT SEGMENT NUMBER: (0 TO EXIT)",Segment
330 EXIT IF Segment=0              ! Exit point
340   OUTPUT @Nwa;"EDITDONE;";"SSEG";Segment;" ! Set active segment to sweep
350 END LOOP                        ! End activation loop
360 !
370 OUTPUT @Nwa;"ASEG;"            ! Set all segment sweep
380 DISP "PROGRAM ENDED"
390 !
400 OUTPUT @Nwa;"OPC?;WAIT;"       ! Wait for analyzer to finish
410 ENTER @Nwa;Reply              ! Read the 1 when complete
420 LOCAL @Nwa                    ! Release HP-IB control
430 STOP                          ! End of main program
440 !
450 ! ***** Subroutines *****
460 !
470 Readlist:                       ! Read segment list from analyzer
480 OUTPUT @Nwa;"EDITLIST;"        ! Edit segment list
490 OUTPUT @Nwa;"SEDI",I,";"       ! Select segment to edit
500 OUTPUT @Nwa;"STAR;"           ! Send start freq to display value
510 OUTPUT @Nwa;"OUTPACTI;"        ! Output active function value
520 ENTER @Nwa;Table(I,1)          ! Read start frequency
530 OUTPUT @Nwa;"STOP;"           ! Send stop freq to display value
540 OUTPUT @Nwa;"OUTPACTI;"        ! Output active function value
550 ENTER @Nwa;Table(I,2)          ! Read stop frequency
560 OUTPUT @Nwa;"POIN;"           ! Send number of points to display
570 OUTPUT @Nwa;"OUTPACTI;"        ! Output active function value
580 ENTER @Nwa;Table(I,3)          ! Read number of points
590 !
600 IF I=18 THEN                   ! Pause if more than 17 segments
610 INPUT "PRESS RETURN FOR MORE",A$ ! Read Return to continue
620 END IF
630 ! Print new header for segment data
640 IMAGE 4D,6X,4D.6D,3X,4D.6D,3X,4D ! Format image to disp segment data
650 PRINT USING 640;I;Table(I,1)/1.E+6;Table(I,2)/1.E+6;Table(I,3)
660 RETURN
670 !
680 END

```

Running the Program

The program will read the parameters for each list-frequency segment from the analyzer, and build a table containing **all** the segments. The parameters of each segment will be printed on the computer screen. If there are more than 17 segments, the program will pause. Press (Return) to see more segments. The maximum number of segments that can be read is 30 (the **maximum** number of segments the analyzer can hold). Use the computer's **Page Up** and **Page Down** keys to scroll through the list of segments if there are more than 17.

After all the segments are displayed, the program will prompt the operator for a specific segment to be used. Type in the number of the segment, and the analyzer will then “zoom-in” on that segment. The program will continue looping, allowing continuous selection of different segments. To exit the loop, type **Q**. This will restore all the segments (with the command ASEG), allowing the analyzer to sweep all of the segments, and the program will terminate.

Using Limit Lines to Perform PASS/FAIL Tests

There are two steps to performing limit testing on the analyzer via HP-IB. First, limit **specifications** must be **defined** and loaded into the analyzer. Second, the limits are activated, the device is measured, and its performance to the specified limits is signaled by a pass or fail message on the analyzer's display.

Example **6C** illustrates the **first** step, setting up limits. Example **6D** performs the actual limit testing.

Example 6C: Setting Up Limit Lines

Note This program is stored as **EXAMP6C** on the “Programming Examples” disk received with the network analyzer.

The purpose of this example is to show how to create a limit-test table and transmit it to the analyzer.

The command sequence for entering a limit-test table imitates the key sequence followed when entering a table from the analyzer’s front panel: there is a command for every key-press+ Editing a limit line is also the same as the key sequence, but remember that the analyzer automatically re-orders the table in order of increasing start frequency.

The limit-test table is also carried as part of the learn string. While it cannot be **modified** as part of the learn **string**, the learn string can be stored and recalled with very little effort. See “Data-Processing Chain” in Chapter 1 for details on using learn strings

This example takes advantage of the computer’s capabilities to simplify creating and editing the table. The table is entered and completely edited before being transmitted to the analyzer. To simplify the programming task, options such as entering offsets are not included.

This example automates the front-panel operation of entering a limit-test table. Front-panel operation and limits are discussed in the “Application and Operation Concepts” in the *HP 8719D/20D/22D Network Analyzer User’s Guide*.

The following is an outline of the program’s processing sequence:

- An I/O path is assigned for the analyzer.
- The system is initialized.
- The limit lines are edited and cleared.
- The number of limits is requested.
- The limit table is created.
- The string array of limit types is created.
- The operator is prompted to enter the new limit values.
- The new limit table is sent back to the analyzer.
- The limit line is activated.
- The limit test is activated.
- The analyzer is returned to local control and the program ends

The program is written as follows:

```
10 ! This program shows how to create a limit table and send it to the
20 ! analyzer. The operator enters the desired limits when prompted for
30 ! the stimulus value, upper and lower value and type of limit
40 ! desired. Once the table is created, the limits are sent to the
50 ! analyzer and activated.
60 !
70 ! EXAMP6C
80 !
90 ASSIGN Qnwa TO 716 ! Assign an I/O path for the analyzer
100 !
110 CLEAR SCREEN
```

```

120 ! Initialize the analyzer
130 ABORT 7 ! Generate an IFC (Interface clear)
140 CLEAR @Nwa ! SDC (Selected Device Clear)
150 OUTPUT @Nwa;"OPC?;PRES;" ! Preset the analyzer and wait
160 ENTER @Nwa;Reply ! Read the 1 when completed
170 !
180 OUTPUT @Nwa;"EDITLIML;" ! Edit limit lines
190 OUTPUT @Nwa;"CLEL;" ! Clear any existing limits
200 INPUT "NUMBER OF LIMITS?",Numb ! Request the number of limits
210 ALLOCATE Table(1:Numb,1:3) ! Create a table
220 ALLOCATE Limtype$(Numb)[2] ! Create string array of limit types
230 !
240 ! Print out the header for the table
250 PRINT USING "10A,20A,15A,20A";"SEG","STIMULUS (MHZ)","UPPER (dB)","
LOWER (dB)", "TYPE"
260 !
270 ! Prompt the operator to enter the limit values
280 FOR I=1 TO Numb ! Cycle through the limits
290 GOSUB Loadlimit ! Go read limit values
300 NEXT I ! Next limit value
310 !
320 ! Allow the operator to edit the array entered
330 LOOP ! Cycle to edit limit lines
340 INPUT "DO YOU WANT TO EDIT? Y OR N",An$
350 EXIT IF An$="N" ! Exit loop on N and send to analyzer
360 INPUT "ENTRY NUMBER?",I ! Read limit number to edit
370 GOSUB Loadlimit ! Go read limit values
380 END LOOP ! Next edit entry
390 !
400 ! Send the limit line array segments to the analyzer
410 OUTPUT @Nwa;"EDITLIML;" ! Edit the limit
420 FOR I=1 TO Numb ! Each segment of the limit
430 OUTPUT @Nwa;"SADD;" ! Add segment
440 OUTPUT @Nwa;"LIMS";Table(I,1);"MHZ" ! Send segment stimulus value
450 OUTPUT @Nwa;"LIMU";Table(I,2);"DB" ! Upper limit value
460 OUTPUT @Nwa;"LIML";Table(I,3);"DB" ! Lower limit value
470 IF Limtype$(I)="FL" THEN OUTPUT @Nwa;"LIMTFL;" ! Flat limit
480 IF Limtype$(I)="SL" THEN OUTPUT @Nwa;"LIMTSL;" ! Sloping limit
490 IF Limtype$(I)="SP" THEN OUTPUT @Nwa;"LIMTSP;" ! Point limit
500 OUTPUT @Nwa;"SDON;" ! Segment done
510 NEXT I ! next segment
520 !
530 OUTPUT @Nwa;"EDITDONE;" ! Edit complete
540 OUTPUT @Nwa;"LIMILINEON;" ! Turn limit line on
550 OUTPUT @Nwa;"LIMITESTON;" ! Turn limit test on
560 !
570 OUTPUT @Nwa;"OPC?;WAIT;" ! Wait for the analyzer to finish
580 ENTER @Nwa;Reply ! Read the 1 when complete
590 !
600 LOCAL @Nwa ! Release BP-IB control
610 STOP ! End of main program
620 !
630 !***** Subroutines *****
640 !
650 Loadlimit: ! Sub to interact to load data

```

```

660 INPUT "STIMULUS VALUE? (MHz)",Table(I,1) ! and print table created
670 INPUT "UPPER LIMIT VALUE? (DB)",Table(I,2)
680 INPUT "LOWER LIMIT VALUE? (DB)",Table(I,3)
690 INPUT "LIMIT TYPE? (FL=FLAT, SL=SLOPED, SP=SINGLE POINT)",Limtype$(I)
700 !
710 ! Format and display table values
720 PRINTTABXY(0,I+1);I;TAB(10);Table(I,1);TAB(30);Table(I,2);TAB(45),
    Table(I,3),TAB(67);Limtype$(I)
730 RETURN ! Next limit value
740 !
750 END

```

Running the Program

Caution This example program will delete any existing limit lines before entering the new limits. If this is not desired, omit the line(s) that clear the existing limits (in this case, the command "**CLEL;**" contained in **LINE 190**). This program begins by presetting the analyzer. The programmer will have to add the necessary command lines to set the analyzer to the operating conditions required for testing. The example program will show the limit lines defined, but the limits will always fail without additional analyzer setup.

The program displays the limit table as it is entered. During editing, the displayed table is updated as each line is edited. The table is not reordered. At the completion of editing, the table is entered into the analyzer, and limit-testing mode switched ON. The **analyzer** will rearrange the table in ascending order **starting** with the lowest start frequency entry. During editing, simply pressing (Enter) leaves an entry at the old value.

Example 6D: Performing PASS/FAIL Tests While Tuning

Note This program is stored as **EXAMP6D** on the “Programming Examples” disk received with the network analyzer.

The purpose of this example is to demonstrate the use of the limit/search-fail bits in event-status register B, to determine whether a device passes the specified limits. Limits can be entered manually, or using the Example 5A.

The limit/search-fail bits are set and latched when limit testing or a marker search fails. There are four bits, one for each channel for both limit testing and marker search. See Figure 2-5 “Status Reporting Structure” and Table 2-4 “Units as a Function of Display Format” for additional information. Their purpose is to allow the computer to determine whether the test/search executed was successful. They are used in the following sequence:

1. Clear event-status register B.
2. Trigger the limit test or marker search.
3. Check the appropriate fail bit.

When using limit testing, the best way to trigger the limit test is to trigger a single sweep. By the time the single sweep command (SING) finishes, limit testing will have occurred.

Note If the device is tuned during the sweep, it may be tuned into and then out of limit, causing a limit test to qualify as “passed” when the device is not in fact within the specified limits

When using marker searches (**max**, min, target, and widths), outputting marker or bandwidth values automatically triggers any related searches. Therefore, **all** that is required is to check the fail bit after reading the data.

In this example, several consecutive sweeps must qualify as “passing” in order to insure that the limit-test pass was not extraneous due to the device settling or operator tuning during the sweep. Upon running the program, the number of “passed” sweeps for **qualification** is entered. For very slow sweeps, a **small** number of sweeps such as two are appropriate. For relatively fast sweeps, where the device requires time to settle after tuning, as many sweeps as six or more sweeps may be more appropriate.

A limit-test table can be entered over HP-IB. The sequence is very **similar** to that used in entering a list-frequency table, as shown in Example 5D. The manual (front-panel entry) sequence is closely followed.

The following is an outline of the program’s processing sequence:

- An I/O path is assigned for the analyzer.
- The system is initialized.
- The pass counter is initialized on entry.
- The analyzer takes a sweep.
- The event-status register B byte is output and the channel-1 limit is tested.
- If the device fails the **first** sweep, the operator is prompted to insure it is tuned correctly and the device is measured again.
- If the device passes the **first** sweep, the operator is prompted not to touch the device as testing continues

- If the device passes the required number of sweeps' the operator is prompted that the device has passed and to connect the next device for testing.
- **The program initializes the pass counter and begins to measure the new device.**

The program is written as follows:

```

10 ! This program demonstrates Pass/Fail tests using limit lines. The
20 ! program uses the latch-on-fail limit bits in event status register
30 ! B to determine if the device performance passes the specified test
40 ! limit lines. It then requires that the device passes for multiple
50 ! consecutive sweeps in order to ensure that the device is static in
60 ! the response and not varying. The operator specifies how many sweeps
70 ! are required to pass the test.
80 !
90 ! EXAMP6D
100 !
110 ASSIGN ONwa TO 716 ! Assign an I/O path for the analyzer
120 !
130 CLEAR SCREEN
140 ! Initialize the analyzer No preset to retain settings for testing
150 ABORT 7 ! Generate an IFC (Interface Clear)
160 CLEAR ONwa ! SDC (Selected Device Clear)
170 !
180 INPUT "Number of consecutive passed sweeps for qualification?",Qual
190 Pass=0 ! Initialize pass counter on entry
200 !
210 Tune: DISP "TUNE DEVICE AS NECESSARY" ! Device is not passing warning
220 !
230 Measure:OUTPUT ONwa;"OPC?;SING;" ! Single sweep and wait
240 ENTER ONwa;Reply ! Read the 1 when completed
250 !
260 OUTPUT ONwa;"ESB?;" ! Event status register B byte
270 ENTER ONwa;Estat ! Reading byte clears the register
280 !
290 IF BIT(Estat,4) THEN ! Bit 4 is failed limit on channel 1
300 IF Pass>0 THEN BEEP 1200, .05 ! passed before? Now not passing beep
310 Pass=0 ! Reset pass to 0
320 GOTO Tune ! Adjust and measure again
330 END IF
340 !
350 BEEP 2500, .01 ! Limit test passed passing beep
360 Pass=Pass+1 ! Increment number of passes
370 DISP "LEAVE DEVICE ALONE" ! Warn not to adjust as it passed
380 !
390 IF Pass<Qual THEN GOTO Measure ! If not enough passes to qualify
400 !
410 ! Device passed
420 DISP "DEVICE PASSED!" ! Number of passes enough to qualify
430 FOR I=1 TO 10 ! Announce the device passed and
440 BEEP 1000, .05 ! prompt operator to connect new
450 BEEP 2000, .01 ! device to test.

```

```
460 NEXT I
470 !
480 INPUT "PRESS RETURN FOR NEXT DEVICE",Dum$
490 Pass=0 ! Initialize pass counter
500 GOTO Measure ! Begin measurement
510 !
520 END
```

Running the Program

Note This program assumes a response calibration (through calibration) or a **full 2-port** calibration has been performed prior to running the program.

Set up a limit-test table on channel 1 for a specific device either manually, or using the program in Example 5A.

Run the program, and enter the number of passed sweeps desired for **qualification**. After entering the qualification number, connect the device. When a sweep passes, the computer beeps. When enough consecutive sweeps qualify the device as "**passing**," the computer emits a dual-tone beep to attract the attention of the operator, and then prompts for a new device.

To test the program's pass/fail accuracy, try causing the DUT to fail by loosening the cables connecting the DUT to the analyzer and running the program again.

Example 7: Report Generation

The analyzer has three operating modes with respect to HP-IB. These modes can be changed by accessing **softkeys** in the (Local) menu. System-controller mode is used when no computer is present. This mode **allows** the analyzer to control the system. The other two modes allow a remote system controller to coordinate certain actions: in talker/listener mode the remote system controller can control the analyzer, as well as coordinate plotting and printing; and in pass-control mode the remote system controller can pass active control to the analyzer so that the analyzer can plot, print, control a power meter, or load/store to disk. The amount of peripheral interaction is the main difference between **talker/listener** and pass-control mode.

Example 7A1: Operation Using Talker/Listener Mode

Note This program is stored as **EXAMP7A1** on the "Programming Examples" disk received with the network analyzer.

The commands **OUTPLOT** and **OUTPPRIN** allow talker/listener mode plotting and printing via a one way data path from the analyzer to the plotter or printer. The computer sets up the path by addressing the analyzer to talk, the plotter to listen, and then releasing control of the **analyzer** in order to transfer the data. The analyzer will then make the plot or print. When it is finished, it asserts the End or Identify (EOI) control line on HP-IB. The controller detects the presence of EOI and reasserts control of the HP-IB. This example program makes a plot using the talker/listener mode.

Note One of the attributes of the **OUTPLOT** command is that the plot can include the current **softkey** menu. The plotting of the **softkeys** is enabled with the **PSOFTON;** command and disabled with the **PSOFTOFF ;** command.

The following is an outline of the program's processing sequence:

- An I/O path is assigned for the analyzer.
- The system is initialized.
- The selected frequency span is swept once.
- The plot command is sent to the analyzer.
- The analyzer is set to talker mode and the plotter is set to listener mode.
- The plot is spooled to the plotter.
- The analyzer is set to listener mode when the controller detects an EOI from the analyzer.
- The controller puts the analyzer back in continuous-sweep mode.
- The analyzer is returned to local control and the program ends

The program is written as follows:

```
10 ! This example shows a plot operation under the control of the
20 ! analyzer. The analyzer is commanded to output plot data, the
30 ! plotter is addressed to listen, and the analyzer to talk. The
40 ! controller watches for EOI at the end of the plot sequence and
50 ! then regains control of the BP-IB operations.
60 !
70 ! EXAMP7A1
80 !
```

```

90 ASSIGN QNwa TO 716          ! Assign an I/O path for the analyzer
100 !
110 CLEAR SCREEN
120 ! Initialize analyzer without preset to preserve data
130 ABORT 7                     ! Generate an IFC ( Interface Clear)
140 CLEAR QNwa                ! SDC (Selected Device Clear)
150 !
160 OUTPUT QNwa;"OPC?;SING;"   ! Stop sweep and prepare for plot
170 ENTER QNwa;Reply         ! Read in "1" when completed
180 !
190 OUTPUT QNwa;"OUTPLOT;"     ! Send plot command
200 SEND 7;UNL LISTEN 5 TALK 16 DATA ! Unlisten address devices and plot
210 DISP "Plotting and waiting for EOI"
220 WAIT .5                     ! Pause 500 mS to start process
230 !
240 REPEAT                     ! Loop until EOI detected bit is set
250   STATUS 7,7;Stat         ! Read HP-IB interface register 7
260 UNTIL BIT(Stat,11)       ! Test bit 11 EOI on HP-IB
270 !
280 End_plot:DISP "End of plot"
290 !
300 OUTPUT QNwa;"CONT;"       ! Restore continuous sweep
310 OUTPUT QNwa;"OPC?;WAIT;" ! Wait for analyzer to finish
320 ENTER QNwa;Reply         ! Read the 1 when complete
330 LOCAL QNwa              ! Release remote control
340 END

```

Running the Program

The analyzer will go into **remote**, and make the plot. During the plot, the computer will display the message **Plotting and waiting for EOI**. When the plot is completed, the analyzer asserts the EOI line on the HP-IB. The computer detects **this** and displays the **End of plot** message.

If a problem arises with the plotter, such as no pen or paper, the analyzer cannot detect the situation because it only has a one-way path of communication. Hence, the analyzer will attempt to continue plotting until the operator intervenes and aborts the plot by pressing the analyzer's **(Local)** key.

Pressing [Local] will do the following:

- Aborts the plot.
- Causes the **warning** message **CAUTION:PLOTABORTED**.
- Asserts EOI to return control of the bus to the system controller.

Because of possible peripheral malfunctions, it is generally advisable to use pass-control mode, which allows two way communication between the peripherals and the analyzer.

Example 7A2: Controlling Peripherals Using Pass-Control Mode

Note This program is stored as **EXAMP7A2** on the “Programming Examples” disk received with the network analyzer.

If the analyzer is in pass-control mode and it receives a command telling it to plot, print, control a power meter, or store/load to disk, it sets bit 1 in the event-status register to indicate that it requires control of the bus. If the computer then uses the HP-IB pass-control command to pass control to the analyzer, the analyzer will take control of the bus and access the peripheral. When the analyzer no longer requires control, it will pass control back to the computer.

In this example, the pass-control mode is used to **allow** the network analyzer to dump a screen display to a printer.

Pass-control mode **allows** the analyzer to control the printer while sending the screen display to be printed. Once the printer-dump operation is complete, the analyzer passes control back to the controller and the controller continues programming the analyzer. The analyzer requests control from the instrument controller and the controller allows the analyzer to take control of the HP-IB and dump the plot. The instrument controller must not interact with the **HP-IB** while this remote analyzer control is taking place.

Note The analyzer assumes that the address of the computer is correctly stored in its HP-IB addresses menu under **(Local) ADDRESS: CONTROLLER**. If this address is incorrect, control will not return to the computer. Similarly, if control is passed to the analyzer while it is in **talker/listener** mode, control will not return to the computer.

Control should not be passed to the analyzer before it has set event-status-register bit 1 making it Request Active Control. If the analyzer receives control before the bit is set, control is passed immediately back to the controller.

When the analyzer becomes the active system controller, it is free to address devices to talk and listen as required. The only functions denied the analyzer are the ability to assert the interface clear line (IFC), and the remote line (REN). These are reserved for the master system controller. As the active system controller, the analyzer can send and receive messages from printers, plotters, and disk drives

The following is an **outline** of the program’s processing sequence:

- An I/O path is assigned for the analyzer.
- The system is initialized.
- The status registers are cleared.
- Bit 1 of ESR request control is set.
- The ESR interrupt for SRQ is enabled.
- The pass-control mode is enabled.
- The data is dumped to the printer.
- The program loops until the SRQ bit is set.
- The status byte is read with a serial poll.
- The program tests for bit 6, SRQ.

- If SRQ is detected, the program tests for pass control (bit 5 of the status byte).
- If the analyzer requests control, the system controller gives the analyzer control of the bus
- The program loops and waits for the analyzer to complete the print dump.
- The analyzer reads the interface.
- If bit 6 is active in the controller, control is returned from the analyzer to the controller.
- The status-byte assignments are cleared.
- The analyzer returns to continuous-sweep mode.
- The analyzer is returned to local control and the program ends.

The program is written as follows:

```

10 ! This example shows a pass-control operation to print the display
20 ! under the analyzer HP-IB control. The controller reads the status
30 ! of the analyzer looking for SRQ to indicate that the analyzer is
40 ! requesting control. Once control is passed to the analyzer, the
50 ! controller monitors the status of its interface registers to detect
60 ! when the interface is again the active controller. The analyzer will
70 ! pass control back to the controller when finished.
80 !
90 ! EXAMP7A2
100 !
110 ASSIGN Qnwa TO 716           ! Assign an I/O path for the analyzer
120 !
130 CLEAR SCREEN
140 ! Initialize the analyzer without preset to preserve data
150 ABORT 7                       ! Generate an IFC ( Interface Clear)
160 CLEAR Qnwa                 ! SDC (Selected Device Clear)
170 !
180 OUTPUT Qnwa;"OPC?;SING;"    ! Single sweep and stop for print
190 ENTER Qnwa;Reply           ! Read in "1" when complete
200 !
210 OUTPUT Qnwa;"CLES;"        ! Clear status registers
220 OUTPUT Qnwa;"ESE2;"        ! Enable bit 1 of ESR request control
230 OUTPUT Qnwa;"SRE32;"      ! Enable ESR interrupt for SRQ
240 !
250 OUTPUT Qnwa;"USEPASC;"     ! Enable pass control mode
260 OUTPUT Qnwa;"PRINALL;"    ! Begin printer dump
270 !
280 REPEAT                         ! Loop until SRQ bit is set
290   Stat=SPOLL(Qnwa)        ! Read status byte with serial poll
300 UNTIL BIT(Stat,6)         ! Test for bit 6, SRQ
310 !
320 Pass-control:                 ! SRQ detected. Test for pass control
330 IF BIT(Stat,5) THEN        ! Requested pass control
340   PASS CONTROL Qnwa      ! Send take control message
350 ELSE                          ! Not bit 5, some other event
360   DISP "SRQ but not request pass control"
370   STOP                        ! Halt program
380 END IF
390 !
400 DISP "Printing from analyzer and waiting for control"
410 !

```

```

420 REPEAT                                ! Loop and wait for completion
430   STATUS 7,6;Hpib                      ! Read HP-IB interface register
440 UNTIL BIT(Hpib,6)                      ! Bit 6 is active controller
450 !
460 DISP "Control returned from analyzer"
470 OUTPUT @Nwa;"TALKLIST;"               ! Set talker/listener mode again
480 OUTPUT @Nwa;"CLES;"                   ! Clear status byte assignments
490 !
500 OUTPUT @Nwa;"CONT;"                   ! Start analyzer sweeping again
510 OUTPUT @Nwa;"OPC?;WAIT;"              ! Wait for analyzer to finish
520 ENTER @Nwa;Reply                       ! Read the 1 when complete
530 !
540 LOCAL @Nwa                             ! Release HP-IB control
550 END

```

Running the Program

The analyzer will briefly flash the message **WAITING FOR CONTROL**, before actually receiving control and generating the printer output. The computer will display the **Printing from analyzer and waiting for control** message.

When the printer output is complete, the analyzer passes control back to the address stored as the controller address under the **(Local) SET ADDRESSES** menu. The computer will detect the return of active control and exit the wait loop. The controller will display the message **Control returned from analyzer** and then release the analyzer from remote control.

Note Because the program waits for the analyzer's request for control, it can be used to respond to front-panel requests as well. Remove the **"PRINALL;"** command from the program and run the program. Nothing will happen until the operator requests a print, plot, or disk access from the front panel of the analyzer. For example, press (Local) **(Copy)** and **PRINT MONOCHROME**.

Example 7A3: Printing with the Serial Port

Note This program is stored as **EXAMP7A3** on the “Programming Examples” disk received with the network analyzer.

This program will select the serial port and program the analyzer to copy its display to a printer. There are a number of commands associated with the serial and parallel ports which allow the programmer to **configure** the output modes, for example the baud rate and the handshake type used by the port and the printer. In this example, the serial port is configured by the program. The interface may also be **configured** from the analyzer’s front-panel keys by pressing **(Local) SET ADDRESSES PRINTER PORT**. This menu allows manual selection of the serial-interface parameters

Since the HP-IB port is not being used for the copy operation, programming of the analyzer and measurement operations may continue once the copy operation has been initiated. An internal spooler in the analyzer’s memory provides buffering of the printer operation. In the example which follows, the status byte of the analyzer is checked to determine when the print operation is complete.

- An I/O path is assigned to the analyzer.
- The analyzer is initialized.
- A single sweep is taken and the analyzer is placed in hold mode.
- The status registers are cleared.
- The copy-complete bit is set and enabled.
- The printer operation and communication modes are set.
- The print command is sent.
- The analyzer is released from remote control and placed in continuous-sweep mode.
- The analyzer is polled until the status bit representing copy complete is detected.
- The analyzer is released from remote control and the program ends

The program is written as follows:

```
10 ! This program shows how to set up and print the display through the
20 ! serial printer port.
30 !
40 ! EXAMP7A3
50 !
60 ASSIGN QWa TO 716 ! Assign an I/O path for the analyzer
70 !
80 CLEAR SCREEN
90 ! Initialize the analyzer without preset to preserve the data
100 ABORT 7 ! Generate an IFC (Interface Clear)
110 CLEAR QWa ! SDC (Selected Device Clear)
120 !
130 OUTPUT QWa;"OPC?;SING;" ! Single sweep and stop for print
140 ENTER QWa;Reply ! Read the 1 when complete
150 !
160 OUTPUT QWa;"CLES;" ! Clear status registers
170 OUTPUT QWa;"ESNB128;" ! Enable copy complete
180 OUTPUT QWa;"SRE4;" ! Enable Event Status Register B
190 OUTPUT QWa;"PRNTRAUTF OFF;" ! Set printer auto feed off
200 OUTPUT QWa;"PRNTYPTJ;" ! Select ThinkJet printer
210 OUTPUT QWa;"PRNPRTSERI;" ! Select serial port for output
220 OUTPUT QWa;"PRNTRBAUD 9600;" ! Set baud rate to 9600 bps
230 OUTPUT QWa;"PRNHNSHK XON;" ! Use Xon-Xoff handshake
240 !
250 OUTPUT QWa;"PRINALL;" ! Print screen
260 !
270 DISP "PRINTING"
280 !
290 ! Set up next measurement over HP-IB
300 OUTPUT QWa;"CONT;" ! Restore continuous sweep
310 !
320 ! Measurements can continue but wait for print to finish
330 REPEAT ! Test for bit 2 (4) ESRB
340 Stat=SPOLL(QWa)
350 UNTIL BIT(Stat,2) ! Wait for printer to complete
360 !
370 DISP "DONE"
380 LOCAL QWa ! Release HP-IB control
390 END
```

Running the Program

Run the program. The analyzer is initialized, set to single-sweep mode, and a sweep is taken. The program sets the system up to print the analyzer's display to an HP **ThinkJet** printer connected to the interface. At this time, the analyzer can continue making measurements as the **ThinkJet** prints the display. When the analyzer display has **finished** printing, the controller displays the message: "DONE", the analyzer is released from HP-IB control, and the program ends.

Example 7B: Plotting to a File and Transferring File Data to a Plotter

Note This program is stored as **EXAMP7B** on the “Programming Examples” disk received with the network analyzer.

Another report-generation technique is to transfer the plotter string to a disk **file**, and retrieve and plot the disk **file** at another time. **Test** time is increased when a hardcopy plot occurs during the measurement process. It may be more convenient to plot the data at another site or time. One solution to this problem is to capture the plot data using the controller and store it to a disk **file**. This disk **file** may then be read from the controller and the contents transferred to a plotter. This next example shows a method of accomplishing this task.

The **analyzer** is initialized without presetting the analyzer. The data that is in place on the analyzer is not disturbed by the program operation. A large string is dimensioned to hold the plotter commands as they are received from the analyzer. The length of this string depends upon the complexity of the analyzer’s display. The analyzer is placed in the single-sweep mode and OPC? ; SING; is used to make sure that operation is complete before plotting. The plotting begins with the OUTPLOT; command.

The string transfer is ended by the controller detecting the EOI line which the analyzer pulls at the end of the transfer. The string transfer terminates and the plot data is now stored in a string in the analyzer.

These strings contain ASCII characters which represent the plotter commands in HP-GL (Hewlett-Packard Graphics Language). A disk file is created and the string is written into the **file** containing the display-plot commands.

Once the strings are transferred to the disk **file**, the **file** pointer is rewound and the data read out into a string for plotting. The string is sent to the plotter which uses the commands to generate a plot.

The following is an outline of the program’s processing sequence:

- An I/O path is assigned for the analyzer.
- An I/O path is assigned for the plotter.
- The system is initialized.
- The string for plotter commands is defined.
- The frequency span is swept once.
- The plotter output is requested and read into the plot string.
- A plot file is created in the controller.
- The plot string is stored into the **disk file**.
- The plot string is read from the disk **file** and sent to the plotter.
- The **analyzer** returns to continuous-sweep mode.
- The analyzer is returned to local control and the program ends

The program is written as follows:

```
10 ! This program shows how to read the plotter output from the analyzer
20 ! and store it in a disk file as an ASCII file. The disk file is then
30 ! read back into the controller and the plot commands sent to a
40 ! plotter to generate the plot of the analyzer display. This allows
50 ! plotting at a different time than data collection.
60 !
70 ! EXAMP7B
80 !
90 ASSIGN QNwa TO 716 ! Assign an I/O path for the analyzer
100 ASSIGN QPlt TO 705 ! Assign an I/O path for the plotter
110 !
120 CLEAR SCREEN
130 ! Initialize the analyzer without preset to preserve data
140 ABORT 7 ! Generate an IFC (Interface Clear)
150 CLEAR QNwa ! SDC (Selected Device Clear)
160 !
170 DIM Plot$[32000] ! Define string for plotter commands
180 !
190 OUTPUT QNwa;"OPC?;SING;" ! Stop sweep for plot and wait
200 ENTER QNwa;Reply ! Read the 1 when complete
210 OUTPUT QNwa;"OUTPLOT;" ! Request plotter output
220 !
230 ENTER QNwa;Plot$ ! Plotter output of analyzer display
240 !
250 INPUT "Plotter output complete. Press RETURN to store on disk.",Reply$
260 !
270 ! Disk file operations
280 ! Create data file on disk  $32000/256 = 125$  records
290 !CREATE ASCII "PLOTFILE:,1400",125 ! Use only once to generate file
300 ASSIGN QFile TO "PLOTFILE:,1400" ! Assign file I/O path
310 OUTPUT QFile;Plot$ ! Write plot string to file
320 !
330 INPUT "Plot to file is complete. Press Return to plot.",A$
340 !
350 ! Read plotter commands from file and send to plotter
360 RESET QFile ! Reset file pointer to beginning
370 ENTER QFile;Plot$ ! Read plot string from file
380 OUTPUT QPlt;Plot$ ! Send plot string to plotter
390 !
400 !
410 DISP "Plot is complete. End of program."
420 OUTPUT QNwa;"CONT;" ! Restore continuous sweep
430 OUTPUT QNwa;"OPC?;WAIT;" ! Wait for analyzer to finish
440 ENTER QNwa;Reply ! Read the 1 when complete
450 LOCAL QNwa ! Release HP-IB control
460 END
```

Running the Program

The program begins by initializing the analyzer and placing it into single-sweep mode. The plotter commands are captured into strings in the controller. The controller display prompts Plotter output complete. Press RETURN to store on disk. Pressing **Return** causes the data to be stored to disk. Once this task is complete, the program prompts once more,

Plot to file is complete. Press Return to plot. After pressing **(Return)** again, the string output is sent to the plotter and the plot begins. Once the plot is complete, the program prompts **Plot is complete. End of program.** and the analyzer begins sweeping and returns to local control.

Utilizing PC-Graphics Applications Using the Plot File

You can use this Example **7B** to generate a plot that can be read into a PC and used in several different graphics generation programs. **HP-GL** is a commonly recognized graphic format and may be used to transfer information to PC application programs such as **CorelDRAW!®**, **Lotus Freelance®** and other graphics packages. By importing the graphics data into these application packages, you can generate reports in many word-processors.

You can then use graphic-data **files** to generate the following:

- test results documentation
- data sheets from testing results
- archival information for a digital-storage medium

If you would like to create a disk **file** for graphics processing, modify the previous program to only store the plotter commands to the disk **file**. Once the **file** is renamed to include the extension **“.hpg.”** the PC will have a DOS-format **file** that can be imported and examined by the graphics package.

Once the HP-GL **file** is present in the DOS **file** system, the HP-GL **file** is imported and examined with the graphics package. The text labels may need to be **rescaled**, but on the whole, the graphics results are quite usable.

Example 7C: Reading ASCII Disk Files to the Instrument Controller's Disk File

Note This program is stored as **EXAMP7C** on the "Programming Examples" disk received with the network analyzer.

Another way to access the analyzer's test results is to store the data onto a disk **file** from the analyzer. This operation generates an ASCII **file** of the analyzer data in a **CITIFILE** format. A typical **file** generated by Example 7C is shown below:

```
CITIFILE A.01.00
#NAVERSIONHP8753C.04.13
NAME DATA
VAR FREQ NAG 11
DATA S[1,1]RI
SEG,LIST-BEGIN
SEG 100000000 200000000 11
SEG,LIST-END
BEGIN
8.30566E-1,-1.36749E-1
8.27392E-1,-1.43676E-1
8.26080E-1,-1.52069E-1
8.25653E-1,-1.60003E-1
8.26385E-1,-1.68029E-1
8.26507E-1,-1.77154E-1
8.26263E-1,-1.87316E-1
8.26721E-1,-1.97265E-1
8.2724E-1,-2.07611E-1
8.28552E-1,-2.19940E-1
8.29620E-1,-2.31109E-1
END
```

This data file is stored by the analyzer under remote control or manually from the front panel. See "Printing, Plotting, or Saving Measurement Results" in the *HP 8719D/20D/22D Network Analyzer User's Guide* for more details on manual operation. This program performs the same steps that are required to manually store a **file** from front panel.

This program stores a **file** in the same manner as an operator would store a **file** on to the analyzer's internal disk drive from the front panel.

This example explains the process of storing the data from the analyzer to a **file** on the internal disk drive. There is also a program to read the data from the **file** into a data array for further processing or reformatting to another file type. The internal drive will store in the same format that is present on the disk. A new disk may be formatted in either **LIF** or DOS. For the example, the assumption has been made that the format transformation has already taken place, and there is a **file** that can be read record by record, from **which** data can be retrieved.

The goal of this example is to recover an array of stimulus frequency along with the trace-data values. **CITIFILES** contain the real and imaginary values of each data point. Some further transformation will be required to obtain magnitude values, for example.

The disk **file** contents for this example are shown above. This **file** contains more information than will be used in this example. The **file** is accessed and the records read from the **file** and printed on the controller display to observe the actual **file** contents. The **file** pointer is reset and the records are then read and interpreted for their data contents.

The **first** six records are skipped for this example. The seventh record contains the stimulus-frequency values and the number of points in the trace. These values are read from the record. The frequency increment, or point spacing, is calculated and used later the frequency-data calculations for a point. Two more records are skipped and the next is the first record representing data values. The data values are read in a loop until the values for the number of points have been recovered from the **file**. The data values are tabulated and printed out on the controller display.

The following is an outline of the program's processing sequence:

- An I/O path is assigned to the analyzer.
- The system is initialized.
- A string is dimensioned to hold a **file** record.
- The analyzer operating state is set.
 - The internal drive is selected for storage (only ASCII data is stored).
- A **file** name is entered and the data stored into it.
 - The operator is prompted to move the disk to the controller disk drive.
- The disk **file** is read and the contents displayed.
 - The **file** pointer is rewound.
 - The **file** contents are converted to trace data.
- The frequency and complex-data pair is displayed for each point.
 - The analyzer is restored to continuous-sweep mode.
 - The analyzer is returned to local control and the program ends.

Note If the command EXTMDATOON is used, it will override all of the other save options (such as EXTMFORMON). Because this type of data is only intended for computer manipulation, the **file** contents of a EXTMDATOON (data only) save cannot be **recalled** and displayed on the analyzer.

The program is written as follows:

```

10 ! This program shows how to store an ASCII data file in CITIFILE format
20 ! and retrieve the data with the controller. The disk is written in the
30 ! analyzer system and then moved to the controller disk and the data
40 ! accessed.
50 !
60 ! EXAMP7C
70 !
80 ASSIGN Qnwa TO 716           ! Assign an I/O path for the analyzer
90 !
100 CLEAR SCREEN
110 ABORT 7                     ! Generate an IFC (Interface Clear)
120 CLEAR Qnwa                 ! SDC (Selected Device Clear)
130 OUTPUT Qnwa;"OPC?;PRES;"   ! Preset the analyzer and wait
140 ENTER Qnwa;Reply         ! Read the 1 when complete
150 !
160 DIM Record$[80]          ! String to read the disk records
170 !
180 ! Set up analyzer

```

```

190 OUTPUT @Nwa;"STAR100MHZ;"           ! Start frequency 100 MHz
200 OUTPUT @Nwa;"STOP 200MHZ"         ! Stop frequency 200 MHz
210 OUTPUT @Nwa;"POIN11;"             ! Trace length 11 points
220 OUTPUT @Nwa;"OPC?;SING;"          ! Single sweep and wait
230 ENTER @Nwa;Reply                  ! Read in the 1 when complete
240 !
250 ! Program disk storage operation
260 !
270 OUTPUT @Nwa;"INTD;"                ! Select internal disk file
280 OUTPUT @Nwa;"EXTMFORMON;"         ! Store formatted data
300 INPUT "Enter data file name (5 chars)",File_name$ ! Get file name
310 File_name$=UPC$(File_name$)       ! File names are uppercase
320 OUTPUT @Nwa;"TITF1""";File_name$;""";" ! Title for save reg 1
330 OUTPUT @Nwa;"SAVUASCII;"          ! Save as ASCII file
340 !
350 OUTPUT @Nwa;"STOR1;"              ! Store data to disk file
360 OUTPUT @Nwa;"OPC?;WAIT;"          ! Wait until store is complete
370 ENTER @Nwa;Reply
380 !
390 ! File storage is complete
400 !
410 INPUT "Place disk in controller disk drive, then press Return",A$
420 !
430 ! Read data file information
440 !
450 ASSIGN @File TO File_name$&"D1:,1400" ! Open an I/O path for file
460 Record_cnt=1                       ! Counter to count records
470 !
480 PRINT CHR$(12);                    ! Formfeed to clear display
490 PRINT "Contents of data file"      ! Show contents of the data file
500 Readfile: !
510 ON END @File GOTO End-file         ! Test for end of file and exit
520 ENTER @File;Record$               ! Read ASCII record
530 PRINT Record_cnt,Record$          ! print record on display
540 Record_cnt=Record,cnt+1           ! Increment record counter
550 GOTO Readfile                     ! Read next record
560 !
570 End-file: !                        ! Reached the end of file
580 PRINT "End of File. ";Record_cnt-1;" Records found"
590 INPUT "Press Return to continue",A$
600 PRINT CHR$(12);                    ! Formfeed to clear display
610 !
620 ! Read file data into arrays
630 !
640 RESET @File                        ! Rewind file pointer to beginning
650 FOR I=1 TO 6
660   ENTER @File;Record$              ! Skip first six records
670 NEXT I
680 ENTER @File;Record$               ! Read frequency data record
690 Record$=Record$[POS(Record$,"")+1] ! skip SEG to first space + 1
700 Startf=VAL(Record$)               ! Read start frequency
710 Record$=Record$[POS(Record$,"")+1] ! Skip to next space + 1
720 Stopf=VAL(Record$)                ! Read stop frequency
730 Record$=Record$[POS(Record$,"")+1] ! Skip to next space +1
740 Num_points=VAL(Record$)           ! Read the number of points

```

```

750 PRINT 'I Number of points in file ";Num_points
760 PRINT                                ! White space
770 !
780 Freq_inc=(Stopf-Startf)/(Num_points-1) ! Compute frequency increment
790 !
800 ALLOCATE Array(Num_points,2)          ! Allocate array from Num_points
810 ENTER @File;Record$                   ! Skip SEG,LIST-END record
820 ENTER @File;Record$                   ! Skip BEGIN record
830 !
840 ! Read in the data array
850 PRINT "Freq (MHz) Data 1      Data 2" ! Table header for data array
860 FOR I=1 TO Num_points                 ! Read in array entries
870   ENTER @File;Record$                 ! Read in the record of 2 entries
880   !
890   Array(I,1)=VAL(Record$)             ! Read first data value
900   Data$=Record$[POS(Record$,"")+1]    ! Skip to comma and next value
910   Array(I,2)=VAL(Data$)               ! Read second data value
920   !
930   Freq=Startf+(Freq_inc*(I-1))        ! Compute stimulus value for array
940   Freq=Freq/1.E+6                     ! Convert frequency to MHz
950   !
960   PRINT Freq,Array(I,1),Array(I,2)    ! Print data array values
970 NEXT I                                 ! Read next array data points
980 !
990 OUTPUT @Nwa;"CONT;"                  ! Restore continuous sweep
1000 OUTPUT @Nwa;"OPC?;WAIT;"           ! Wait for analyzer to finish
1010 ENTER @Nwa;Reply                    ! Read the 1 when complete
1020 LOCAL @Nwa                          ! Release HP-IB control
1030 END

```

Running the Program

The analyzer is initialized and the operating range re-defined to an **11-point** trace from 100 to 200 MHz. This setup gives a restricted range to be evaluated when the ASCII data **file** (CITIFILE) is read in from the controller. The operator is prompted for a **5-character** filename to use for storing the data. The analyzer is setup for external storage and stores the data **file**. Once the "pass control/storage/return control" operation is complete, the operator is prompted to place the disk in the controller disk drive and press **Return**. The disk is then read and the records contained in the file are printed on the controller display. A prompt appears, **Press return to continue**, which allows viewing of the file contents. Once **Return** is pressed, the data records are read and decoded and a table of the stimulus frequency and the data values are printed.

Example 8: Mixer Measurements

The program included in Example 8 is one of several mixer measurements discussed in the "Making Mixer Measurements" chapter of the *HP 8719D/20D/22D Network Analyzer User's Guide*.

Example 8A: Comparison of Two Mixers — Group Delay, Amplitude or Phase

Note This program is stored as **EXAMP8A** on the "Programming Examples" disk received with the network analyzer.

Using this program, you can measure how two mixers compare in terms of group delay, amplitude or phase. Refer to **Figure 2-3**.

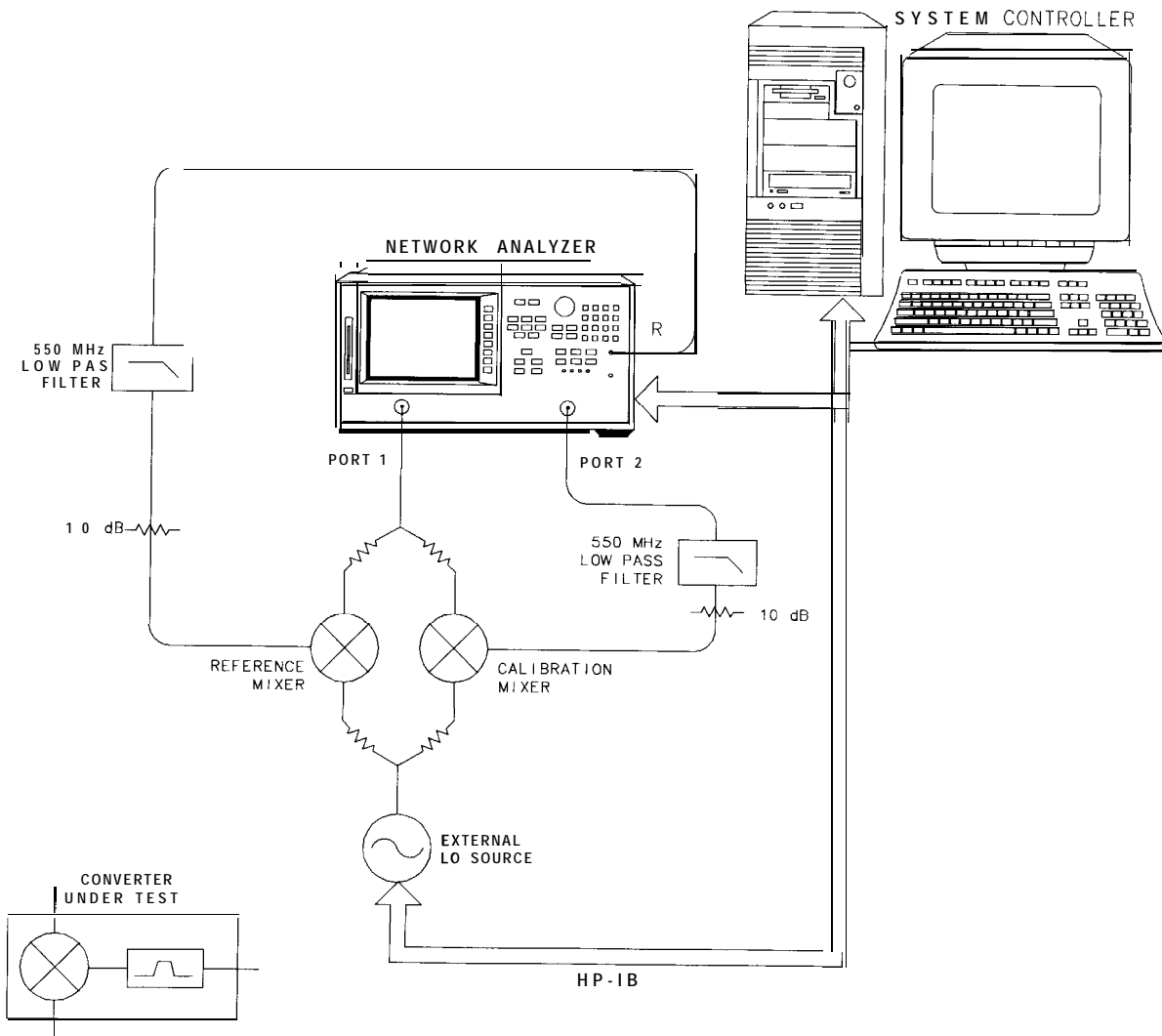

Figure 2-3. Connections: Comparison of Two **Mixers** — Group Delay, Amplitude or Phase

The following is an outline of the program's processing sequence:

- I/O paths are assigned for the analyzer and external source.
- The system is initialized.
- The system operator is prompted for the LO and IF frequencies.
- The external source frequency and power level are adjusted.
- The analyzer's IF frequency settings and power level are adjusted.
- The frequency offset mode settings are initialized and the mode is activated.
- A response calibration is performed.
- The system operator is prompted for the type of measurement.
- The selected type of measurement is performed and the display is autoscaled.
- The analyzer and source are released from remote control and the program ends

The program is written as follows:

```

1      ! This program demonstrates swept IF measurement of group delay,
2      ! amplitude tracking or phase tracking of a mixer under test
3      ! relative to a known "calibration mixer". The external source
4      ! (LO) must be prepared to accept SCPI commands.
5      !
6      ! EXAMP8A
7      !
8 ASSIGN ONwa TO 716          ! Assign an I/O path to the analyzer
9 ASSIGN OSrc TO 719         ! Assign an I/O path to the source
10     !
11 CLEAR SCREEN
12     ! Initialize
13 ABORT 7                    ! Generate an IFC (Interface Clear)
14 CLEAR ONwa                ! Analyzer SDC (Selected Device Clear)
15 OUTPUT ONwa;"OPC?;PRES;"  ! Preset the analyzer
16 ENTER ONwa;Reply         ! Read the 1 when complete
17 CLEAR OSrc                ! Source SDC
18 REMOTE OSrc               ! Prepare source for remote commands
19 OUTPUT OSrc;"*RST"      ! Preset the source
20     !
21     ! Request LO and IF frequency settings
22 INPUT "Enter LO frequency in MHz",Lofreq
23 INPUT "Enter IF center frequency in MHz",Cent
24 INPUT "Enter IF frequency span in MHz",Span
25     !
26     ! Program source settings
27 OUTPUT OSrc;"Freq:CW";Lofreq;"MHZ"
28 OUTPUT OSrc;"POW:STAT ON"
29 OUTPUT OSrc;"POWER:LEVEL 13 DBM; STATE ON"
30     !
31     ! Program analyzer settings
32 OUTPUT ONwa;"CENT";Cent;"MHZ;"
33 OUTPUT ONwa;"SPAN";Span;"MHZ;"
34 OUTPUT ONwa;"PWR PMAN;"          ! Manual power range
35     !
36     ! The next two lines are optimized for the 87531).
37     ! The LOPOWER command will simply return the message

```

```

38      ! "FUNCTION NOT AVAILABLE" on an 8719/20/22D. On an
39      ! 8722D, change line 41 to read "POWE -10 DB;"
40      !
41 OUTPUT @Nwa;"POWE 0 DB;"           ! Set power to 0 dBm
42 OUTPUT @Nwa;"LOPOWER 13 DB;"      ! Report LO power to analyzer
43 OUTPUT @Nwa;"LOFREQ";Lofreq;"MHZ;" ! Report LO freq to analyzer
44 OUTPUT @Nwa;"DCONV;"              ! Down conversion
45 OUTPUT @Nwa;"RFLTLO;"             ! RF < LO
46 OUTPUT @Nwa;"FREQOFFS ON;"        ! Turn on frequency offset mode
47 OUTPUT @Nwa;"BR;"                 ! Measure B/R
48 OUTPUT @Nwa;"CALIRESP;"           ! Begin response cal
49 OUTPUT @Nwa;"STANC;"              ! Measure THRU
50 OUTPUT @Nwa;"RESPDONE;"          ! Response cal done
51 REPEAT
52      !
53      ! Request type of measurement
54 PRINT "Enter a number for the type of measurement as follows:"
55 PRINT
56 PRINT "1) Group Delay"
57 PRINT "2) Amplitude Tracking"
58 PRINT "3) Phase Tracking"
59 INPUT "",Meas
60      !
61      ! Perform the selected type of measurement
62 SELECT Meas
63 CASE 1
64 GOSUB Connect,mu
65 OUTPUT @Nwa;"DELA;"               ! GROUP DELAY display format
66 INPUT "Enter electrical delay of calibration mixer in ns",Eled
67 OUTPUT @Nwa;"ELED";Eled;"NS;"
68 OUTPUT @Nwa;"AUTO;"              ! Autoscale the display
69 Again=0
70 CASE 2
71 OUTPUT @Nwa;"LOGM;"               ! LOG MAG display format
72 OUTPUT @Nwa;"DATI;"              ! DATA -> MEMORY
73 GOSUB Connect_mu
74 OUTPUT @Nwa;"DISPDDM;"           ! Display DATA/MEM
75 OUTPUT @Nwa;"AUTO;"              ! Autoscale the display
76 Again=0
77 CASE 3
78 OUTPUT @Nwa;"PHAS;"              ! PHASE display format
79 OUTPUT @Nwa;"DATI;"              ! DATA -> MEMORY
80 GOSUB Connect_mu
81 OUTPUT @Nwa;"DISPDDM;"           ! Display DATA/MEM
82 OUTPUT @Nwa;"AUTO;"              ! Autoscale the display
83 Again=0
84 CASE ELSE
85 Again=1
86 END SELECT
87 UNTIL Again=0
88 DISP "Program completed"
89 LOCAL 7                          ! Release HP-IB control
90 STOP
91 Connect_mu:                        ! Prompt system operator to replace mixer
92 DISP "Remove calibration mixer, connect MUT, then press Continue"

```

```
93 PAUSE
94 RETURN
95 END
```

Running the Program

The analyzer and source are initialized and the operator is queried for the LO frequency, IF center frequency and span. The source frequency and power level are set, and the analyzer frequency settings and power level are adjusted as well. The analyzer frequency offset mode settings are adjusted, the frequency offset mode is turned on, and a response calibration is performed. The operator is queried for the type of measurement, which is then performed, and the program ends.

Limit Line and Data Point Special Functions

The analyzer has special functions in the area of limit testing and in the detection of **min/max** data points within limit segments. The information in this section will teach you how to use these limit line and data point special functions. The following topics are included:

■ Overview

- Constants Used Throughout This Document
- Output Limit Test Pass/Fail Status Per Limit Segment
- Output **Pass/Fail** Status For All Segments
- Output Minimum and Maximum Point Per Limit Segment
- Output Minimum and Maximum Point For All Segments
- Output Data Per Point
- Output Data Per Range of Points
- Output Limit **Pass/Fail** by Channel

Overview

The limit line and data point special functions are available as remote commands only. Each command is overviewed in Table 2-5.

Table 2-5. Limit Line and Data Point Special Functions Commands

Action	Mnemonic	syntax	?	Description
MIN/MAX DATA DETECTION PEB LIMIT SEGMENT				
Min/max recording	MINMAX<ON OFF>	2	1,0	Enables/disables min/max recording per segment. Min and max values are recorded per limit segment.
Max values	OUTPAMAX	1		Outputs max values for all limit line segments. OUTPAMAX values and OUTPAMIN values are both output using OUTPSEGAM.
Min values	OUTPAMIN	1		Outputs min values for all limit line segments. OUTPAMIN values and OUTPAMAX values are both output using OUTPSEGAM.
Min/max values	OUTPSEGAM	1		Outputs limit test min/max for all segs. Outputs the segment number, max stimulus, max value, min stimulus, and min value for all active segments.†
Min/max value	OUTPSEGM	1		Outputs limit test min/max for a specified segment. See SELSEGE[D].†
Segment	SELSEGE[D]	3	D	Selects segment number for the OUTPSEGF and OUTPSEGM commands to report on. D can range from 1 to 18.†
OUTPUT TRACE DATA BY SELECTED POINTS				
Last point	SELMAXPT[D]	3	D	Selects the last point number in the range of points that the OUTPDATR command will report. D can range from 0 to the number of points minus 1.
First point	SELMINPT[D]	3	D	Selects the first point number in the range of points that the OUTPDATR command will report. D can range from 0 to the number of points minus 1.
specify point	SELPT[D]	3	D	Selects the single point number that the OUTPDATP command will report. D can range from 0 to the number of points minus 1.
Data: point	OUTPDATP	1		Outputs a single trace data value indexed by point. (see SELPT[D])
Data: range	OUTPDATR	1		Outputs trace data for range of points. (see SELMINPT[D], SELMAXPT[D])
† For the definition of a limit segment, see “Example Display of Limit Lines.”				

Table 2-5 (cont). Limit Line and Data Point Special Functions Commands

Action	Mnemonic	syntak ?		Description
LIMIT TEST STATUS BY CHANNEL				
Limit test: ch1	OUTPLIM1	1		Outputs status [§] of limit test for channel 1.
Limit test: ch2	OUTPLIM2	1		Outputs status [§] of limit test for channel 2.
LIMIT TEST STATUS BY SEGMENT				
Segment	SELSEG[D]	3	D	Selects the segment number for the OUTPSEGF and OUTPSEGM commands to report on. D can range from 1 to 18. [†]
Limit test status	OUTPSEGAF	1		Outputs the segment number and it's limit test status [§] for all active segments. [†]
Limit test status	OUTPSEGF	1		Outputs the limit test status [§] for a specified segment. See SELSEG[D]. [†]
LIMIT TEST STATUS BY POINT				
Fail report	OUTPFAIP	1		This command is similar to OUTPLIMF except that it reports the number of failures first, followed by the stimulus and trace values for each failed point in the test (note: use command LIMITEST<ON> to function properly).
[†] For the definition of a limit segment, see 'Example Display of Limit Lines.' [§] Values returned for limit test status are: 1 (PASS), 0 (FAIL), -1 (NO LIMIT)				

Example Display of Limit Lines

The features that output data by limit segment are implemented based on the current **definition** of a limit segment. The actual limit lines formed by the limit table almost never have a 1-for-1 relationship with the segment numbers in the limit edit table. Out of 18 segments in the limit table, you can create 18 limit lines if (a) all limit segments are contiguous and (b) the last segment extends to the stop frequency. Otherwise, terminating a segment requires a single point which means that constructing a limit line requires two entries (segments) of the limit table. Thus you have a minimum of 9 lines available and those lines will not be referenced by sequential segment numbers.

Figure 2-4 is an example of a screen print of limit lines set up on the two instrument channels. The limit line examples shown are of Flat Line, Slope Line and Single Point Limits. See **Table 2-6**.

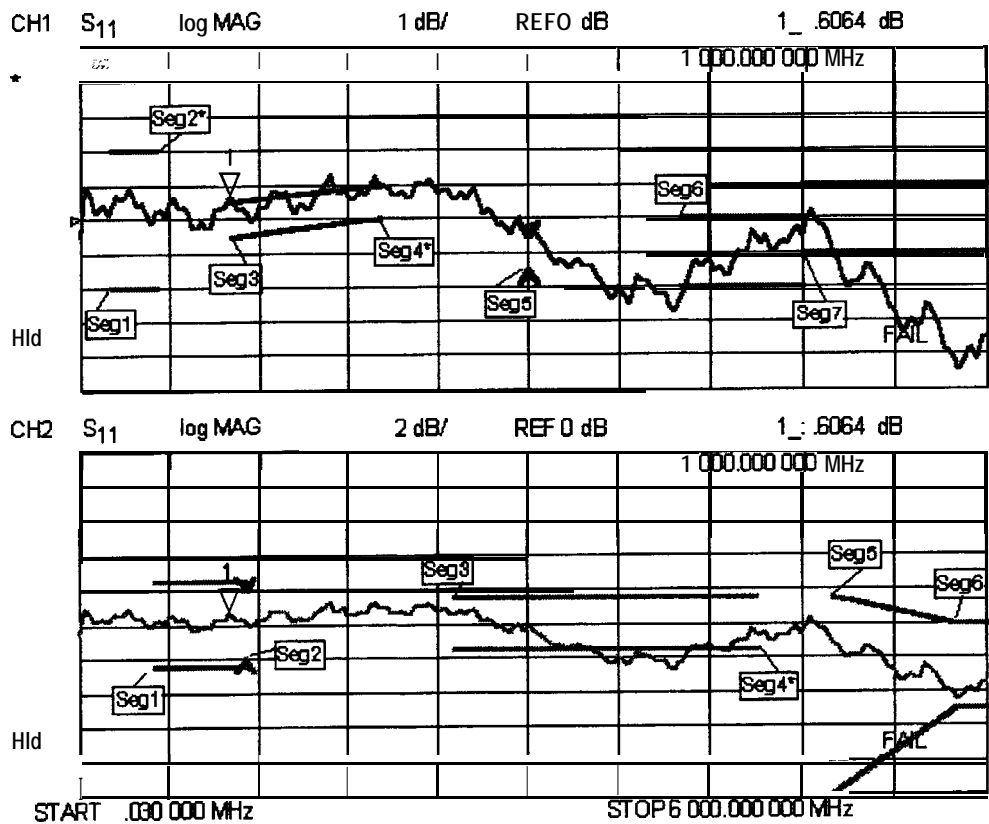

cg65d

Figure 2-4. Limit Segments Versus Limit **Lines**

Limit Segments

The values in **Table 2-6** were used to create the limit lines in **Figure 2-3**.

Table 2-6. Limit Segment Table for Figure 2-3

Segment Num.	Stimulus (Frequency)	Upper Limit (dB)	Lower Limit (dB)	Limit Type
Channel 1				
1	200 MHz	2	- 2	Flat Line (FL)
2*	500 MHz	2	- 2	Single Point (SP)
3	1000 MHz	0.5	-0.5	Slope Line (SL)
4*	2000 MHz	1	0	Single Point (SP)
5	3000 MHz	-0.5	-1.5	Single Point (SP)
6	4000 MHz	0	-2	Flat Line (FL)
7	4800 MHz	1	-1	Flat Line (FL)
Channel 2				
1	500 MHz	2.5	-2.5	Flat Line (FL)
2	1100 MHz	2	-2	Single Point (SP)
3	2500 MHz	1.5	-1.5	Flat Line (FL)
4*	4500 MHz	1.5	-1.5	Single Point (SP)
5	5000 MHz	1.5	-10	Slope Line (SL)
6	5800 MHz	0	- 5	Slope Line (SL)
* No test limit-segment is created.				

Note that if a single point limit is used to terminate slope lines, no test limit-segment is created. (See **Figure 2-4: CH1, Seg4.**) Also, if a single point limit is used to terminate a flat line, no test limit-segment is created. (See **Figure 2-4: CH1, Seg2.**) However, if the single point limit used to terminate the flat line limit has different limit values, a single-point test limit-segment is created. (See **Figure 2-4: CH2, Seg2.**)

Output Results

Table 2-7 shows the output of the OUTPSEGAM test (min/max of all active segments); note that the segments with asterisks (*) from Table 2-6 have no output in Table 2-7.

Table 2-7. Example Output: OUTPSEGAM (min/max of all segments)

channel 1 Segment	Freq. at Minimum Value (Hz)	Minimum Value (dB)	Freq. at Maximum Value (Hz)	Maximum Value (dB)
1	480027600	-0.1268225	330028360	0.9690923
3	1140024300	-0.09223464	1680021600	1.268809
5	3000016000	-0.2199298	3000016000	-0.2199298
6	4020009900	-2.203248	4770006160	-0.2444123
7	5820000900	-4.473376	4360006700	0.23913
Channel 2 Segment				
1	780026100	-0.2838693	990026060	0.8268904
2	1110024460	0.2364199	1110024460	0.2364199
3	3960010200	-2.746686	2640016800	0.888033
5	5790001060	-4.136463	6010004960	-1.064739
6	5820000900	-4.472694	6000000000	-3.601008

Constants Used Throughout This Document

Note The logic values attached to pass and fail indicators were chosen to be consistent with the current logic used in the standard **OUTPLIML** and **OUTPLIMF** commands.

Table 2-8. Pass/Fail/No Limit Status Constants

Status Definition	Status Indicator
PASS	1
FAIL	0
NO_LIMIT	-1

Table 2-8 is an interpretation of the Pass/Fail/No-Limit status constants. These constants are used to identify the Pass/FM/No-Limit state on the data strings if status is returned.

Table 2-9. Min/Max Test Constants

String	Stimulus Value	Data Value
NO-DATA	0	-1000

Table 2-9 is an interpretation of the **min/max** test constants. If the selected segment has no associated limit, the NO-DATA string is generated, which reports a stimulus value of 0 and a data value of -1000.

Output Limit Test Pass/Fail Status Per Limit Segment

Two commands **allow** you to query the pass/fail test status on a limit segment basis: (See previous discussion about segment numbers)

- SELSEG[D] will select the segment.
- OUTPSEGF will return the status of the limit test for that segment: 1 (PASS), 0 (FAIL) or -1 (NO-LIMIT) if no limit exists for the selected segment number. Due to the non-sequential numbering of actual limit line segments on the screen, some segment numbers will have no associated limits and will thus return NO-LIMIT (-1).

Under the following conditions, OUTPSEGF will issue the following errors:

- If the limit testing is OFF: "30: Requested Data Not Currently Available." lb clear the error message, turn the limit test ON.
- If the limit table is empty: "204: Limit Table Empty" (this is a new message). lb clear the error message, enter a limit table.

In both cases, the error is issued and the command responds with -1 (NO-LIMIT).

The **argument** for SELSEG[D] is limited by the maximum number of segments **allowed** in the limit table, which is currently 18. The **minimum** value for the argument is 1. If the user inputs a number that is outside this range, the active entry limits are invoked, causing the analyzer to return the status for limit 18.

Example:

Sending **SELSEG3** and OUTPSEGF may return the following:

1 (segment number 3 passed)

Note The output is ASCII. Currently, the formatting for integer numbers appears to append a trailing space.

Output Pass/Fail Status for All Segments

The HP-IB command `OUTPSEGAF` will return the number of segments being reported, followed by pairs of data consisting of the segment number and its status. A segment is reported only if it has an associated limit. The output is only valid if limit test is on. See the previous discussion on pass/fail limits per segment for error conditions.

Example:

Sending `OUTPSEGAF` may return the following:

```
3
1,0
3,1
5,0
```

For an explanation of these results, see table **Table 2-10**.

Note A new Line Feed character [LF] is inserted after the number of segments and after each data pair

Table 2-10. Example Output: OUTPSEGAF (pass/fail for all segments)

SEGMENTS REPORTED	SEGMENT NUMBER	STATUS	STATUS DEFINITION
3			
	1	0	FAIL
	3	1	PASS
	5	0	FAIL

Table 2-10 is an interpretation of the data returned by the command `OUTPSEGAF`. For clarification, status **definition** is also included.

Example Program of `OUTPSEGAF` Using BASIC

The following program is not included on the Programming Examples disk:

```
10 OUTPUT 716; "outpsegaf;"
20 ENTER 716; Numsegs
30 PRINT "Receiving status for"; Numsegs; "segments."
40 IF Numsegs>0 THEN
50   FOR I=1 TO Numsegs
60     ENTER 716; Segnum, Pf
70     PRINT USING "DD, 2X, 8A"; Segnum, Pf
80   NEXT I
```

The example program shows how the `OUTPSEGAF` command can be used to request the number of active segments and their status. Notice that each segment result must use a new enter command as a line feed terminates each segment data result.

Output Minimum and Maximum Point Per Limit Segment

The command “**MINMAX**”[ON|OFF] toggles a feature which records the minimum and maximum data points in all active limit segments. Note that limit testing need not be turned on.

The command **OUTPSEGM** will report the **min/max** data for the segment previously selected by **SELSEG[N]**. The data is returned in a comma delimited string with the segment number, minimum point stimulus, minimum trace value, maximum point stimulus and maximum trace value.

Under the following conditions, **OUTPSEGM** will issue the following errors:

- If the **min/max** testing is OFF: “30: Requested Data Not Currently Available.” To clear the error message, turn the **min/max** testing ON.
- If the limit table is empty: “204: Limit **Table** Empty” (this is a new message). To clear the error message, enter a new limit table.

When the above error conditions occur, there is no data to report, thus no output is generated.

If the selected segment has no associated limit, the NO-DATA string is generated, which reports a stimulus value of 0 and a data value of -1000.

Example:

Sending **SELSEG3** and **OUTPSEGM** may return the following:

3, 1.900000000E+09, -9.900000E-01, 2.123456789E+09, 2.123456E+00

For an explanation of these results, see **Table 2-11**.

Table 2-11. Example Output: OUTPSEGM (min/max per segment)

SEGMENT	MN PT STIMULUS (FREQUENCY)	MIN PT VALUE (dB)	MAX PT STIMULUS (FREQUENCY)	MAX PT VALUE (dB)
3	1.9 GHz	-.99	2.12 GHz	2.12

Table 2-11 is an interpretation of the **min/max** data returned using the **SELSEG[N]** and **OUTPSEGM** commands

Note A new Line Feed character [LF] is inserted after the segment number and after each data pair.

Output Minimum and Maximum Point For All Segments

Three HP-IB commands **allow** the user to dump the min-or-max or min-and-max values for **all** active segments:

- **OUTPSEGAM**: outputs min and max data for each active segment.
- **OUTPAMIN**: outputs the min data for each active segment.
- **OUTPAMAX**: outputs the max data for each active segment.

The OUTPSEGAM output consists of :

- The total number of segments being reported.
- The following data for each segment:
 - segment number
 - min stimulus
 - min **value**
 - max **stimulus**
 - max **value**

Example:

Sending OUTPSEGAM may return the **following**:

```

5 ,
1 , 1.900000000E+09, -9.900000E-01, 2.123456789E+09, 2.123456E+00
3 , 2.300000000E+09, -10.00000E-01, 2.600000000E+09, 3.100000E+00
5 , 3.200000000E+09, -10.00000E-01, 3.400000000E+09, 3.100000E+00
7 , 4.300000000E+09, -10.00000E-01, 4.700000000E+09, 3.100000E+00
8 , 5.000000000E+09, -10.00000E-01, 5.400000000E+09, 3.100000E+00
    
```

For an explanation of these **results**, see table Table 2-12.

Note A new Line Feed character [LF] is inserted after the segment number and after each data pair.

Table 2-12. Example Output: OUTPSEGAM (min/max for all segments)

SBGMENTS REPORTED	SEGMENT NUMBER	MIN PT STIMULUS (FREQUENCY)	MIN PT VALUE (dB)	MAX PT STIMULUS (FREQUENCY)	MAXPT VALUE (dB)
5					
	1	1.9 GHz	-0.99	2.12 GHz	2.12
	3	2.3 GHz	-1.0	2.6 GHz	3.1
	5	3.2 GHz	-1.0	3.4 GHz	3.1
	7	4.3 GHz	-1.0	4.7 GHz	3.1
	8	5.0 GHz	-1.0	5.4 GHz	3.1

Table 2-12 is an interpretation of the **min/max** data returned using the OUTPSEGAM command.

Example Program of OUTPSEGAM Using BASIC

The following program is not included on the Programming Examples disk:

```
10 Minmax:
20 Mm:  IMAGEDD,":",2X,D.DDDE,2X,SD.DDDE,2X,D.DDDE,2X,SD.DDDE
30      PRINT "TESTING: OUTPSEGAM: min/max points for each segment"
40      OUTPUT716;"minmaxon;"
50      OUTPUT716;"outpsegam;"
60      ENTER 716;Numsegs
70      PRINT "receiving data for";Numsegs;"segments"
80      FOR I=1 TO Numsegs
90          ENTER716;Segnum,Minstim,Minval,Maxstim,Maxval
100         PRINT USING Mm;Segnum,Minstim,Minval,Maxstim,
           Maxval
110      NEXT I
```

Output Data Per Point

The HP-IB command OUTPDATP returns the value of the selected point using **FORM4** (ASCII). The point is selected using the **SELPT[N]** command. This returns the last point if the selected point is out of range. Otherwise, it uses the same format as that used by the marker value command. These formats are as follows:

Table 2-13. Example Output: OUTPDATP (data per point)

Display Format	Marker Mode	Marker Readout Format	Example Returns	
Log Mag		dB, *	-3.521 (dB)	9.7E-39*
Phase		degrees, *	157.8 (Deg)	5.3x10 ⁻¹⁵ *
Delay		seconds, *	0.5068x10 ⁻⁹	0*
Smith Chart	LIN MKR	lin mag, degrees		
	LOG MKR	dB, degrees		
	Re/Im	real, imag		
	R + jX	real, imag ohms	10.37 Ω	9.399 Ω
	G + jB	real, imag Siemens		
POLAR	LIN MKR	lin mag, degrees	0.6667	157.8 (Deg)
	LOG MKR	dB, degrees	-3.521 (dB)	157.8 (Deg)
	Re/Im	real, imag	-0.6173	0.2518
LIN MAG		lin mag, *	0.6667	0*
REAL		real, *		
SWR		SWR, *	5.001	0*
* Value is insignificant, but is included in data transfers.				

The commands in the following example are sent while using the format command **LOGM**.

Example:

Sending **SELPT5** and **OUTPDATP** may return the following:

-3.513410E+00,0.00915E+15 (Note that the second number is **insignificant**.)

Output Data Per Range of Points

The HP-IB command OUTPDATR returns the value of the selected points using **FORM4** (ASCII). This ASCII format requires many data bytes per point for transfer. For a large number of points, it may be faster to make trace data dumps (OUTPDATA) using a binary format. The range of points is selected using the **SELMINPT[N]** and **SELMAXPT[N]** commands (select minimum point, select maximum point of desired point range). These commands return the last max point if the selected points are out of range. **Only** the SELMAXPT will be returned if the selected minimum point is greater than the selected maximum point.

The commands in the following example are sent **while** using the format command LOGM.

Example:

Sending **SELMINPT5,SELMAXPT7** and OUTPDATR may return the following:

3.880465E-01,0.000039E-01

1.901648E-01,1.363988E+11

5.57587E-01, 1.258655E + 30 (Note that the second number is **insignificant**)

For an explanation of these results see **Table 2-14**.

Note A new Line Feed character [LF] is inserted **after** the segment number and after each data pair.

Table 2-14. Example Output: OUTPDATPR (data per range of points)

POINT	VALUE	VALUE*
5	.3880465	0.000039E-01
6	.1901648	1.363988E+11
7	.557587	1.258655E+30
• These values are insignificant.		

Table 2-14 is an interpretation of the **min/max** data per range of points returned using the **SELMINPT5, SELMAXPT7** and OUTPDATR commands.

Output Limit Pass/Fail by Channel

The HP-IB commands **OUTPLIM1** and **OUTPLIM2** output the status of the **limit** test for channel 1 and channel 2, respectively.

These commands return the values 1 (PASS), 0 (FAIL), or -1 (NO-LIMIT) if **limit** testing is disabled. Currently, the results of **limit** testing can be retrieved by reading a bit in the status register.

Example:

Sending **OUTPLIM1** or **OUTPLIM2** (channel 1 or channel 2) may return the following:

1 (PASS), 0 (FAIL), or if **limit** test not enabled then -1 (NO-LIMIT).

Index

Special characters

\$, 1-39

A

AB, 1-50, 1-69

abort message (IFC), 1-17

abort sequence, 2-8

ADAP1[D], 1-39, 1-69

adapter

coax, 1-69

waveguide, 1-69

adapter delay, 1-69

adapter removal

coax, 1-69

compute new **cal** set, 1-83

recall cal set, 1-71

waveguide, 1-69

adapter removal calibration, 2-27

additional information, 2-1

BASIC 6.2, 2-1

ADDRCONT[D], 1-50, 1-69

ADDRDISC[D], 1-50, 1-69

address

controller, 1-69

disk drive, 1-69

peripheral, 1-69

plotter, 1-69

power meter, 1-69

printer, 1-69

address capability, 1-13

addresses for HP-IB, 1-17

ADDRPERI[D], 1-58, 1-69

ADDRPLOT[D], 1-50, 1-69

ADDRPOWM[D], 1-50, 1-69

ADDRPRIN[D], 1-50, 1-69

adjust brightness, 1-71

adjust color, 1-72

adjust tint, 1-98

ADPTCOAX, 1-39, 1-69

ADPTWAVE, 1-39, 1-69

AH1 (full-acceptor handshake), 1-14

ALC, 1-69

ALC control, 1-69

ALTAB, 1-41, 1-69

alternate inputs, 1-69

amplitude and phase tracking, 2-100

amplitude tracking, 2-100

ANAB<ON|OFF>, 1-59, 1-69

ANAI[D], 1-50, 1-69

analog bus, 1-69

analog input, 1-69

analyzer array-data formats, 1-23

analyzer bus mode, 1-16

analyzer command syntax, 1-8

analyzer control of peripherals, 1-16

analyzer data reading, 1-20

analyzer-debug mode, 2-14

analyzer features helpful in developing programs, 2-14

analyzer identification, 1-20

analyzer operating modes, 2-4

pass-control mode, 2-4, 2-88

system-control mode, 2-4

talker/listener, 2-4

analyzer operation, 1-19

analyzer single bus concept, 1-15

analyzer status reporting structure, 1-30

appendage in syntax, 1-9

AR, 1-50, 1-69

array-data formats, 1-23, 2-46

FORM 1,246

FORM2, 2-46

FORM 3,246

FORM4, 2-44, 2-46

FORM5, 2-46

arrays of data, 1-26

arrays related to frequency, 1-25

ASCII

save format, 1-94

ASCII disk files, 2-96

reading, 2-96

ASEG, 1-53, 1-54, 1-69

assert sequence, 1-69

ASSS, 1-58, 1-69

ATN (attention) control line, 1-12

ATT[A][D], 1-52, 1-69

ATT[B][D], 1-52, 1-69

attention (**ATN**) control line, 1-12

attenuator A, 1-69

attenuator B, 1-69

attenuator offsets, 2-36

AUTO, 1-57, 1-69

auto feed
 plotter, 1-89
 printer, 1-91
auto scale, 1-69
AUXC<ON|OFF>, 1-48, 1-69
averaging, 1-69
 restart, 1-69
averaging factor, 1-69
AVERFACT[D], 1-39, 1-69
AVERO<ON|OFF>, 1-39, 1-69
AVERREST, 1-39, 1-69

B

BACI[D], 148, 1-69
background intensity, 1-69
BANDPASS, 1-61, 1-69
basic **talker (T6)**, 1-14
baud rate
 plotter, 1-89
 printer, 1-91
beep
 emit, 1-76
BEEPDONE<ON(OFF)>, 148, 1-69
beeper on done, 1-69
beeper on warning, 1-69
BEEPFail<ON|OFF>, 1-60, 1-69
BEEPWARN<ON|OFF>, 148, 1-69
begin **cal** sequence, 1-70
bidirectional **lines**, 1-12
binary
 save format, 1-94
BLAD<ON|OFF>, 148, 1-70
blank display, 1-70
BR, 1-50, 1-70
bus device modes, 1-15
bus structure, 1-11, 1-12

C

CO[D], 141, 1-70
C10 (pass control capabilities), 1-14
C1, C2, C3 (system controller capabilities),
 1-14
C1[D], 141, 1-70
C2[D], 141, 1-70
C3[D], 141, 1-70
CAL1, 1-63, 1-70
CALFCALF[D], 145, 1-70
CALFFREQ[D], 145, 1-70
CALFSENA, 145, 1-70
CALFSENB, 145, 1-70
calibrating the test setup, 2-11
calibration
 adapter removal, 2-27
 power meter, 1-91
 simulated, 2-29

 using raw data, 2-29
calibration arrays, 1-35
calibration/classes relationship, 1-34
calibration coefficients, 1-26, 1-29, 1-35
calibration command sequence, 1-34
calibration data
 inputting, 2-68
 outputting, 2-68
 reading, 2-68
calibration kit, 2-2
calibration kits, 1-70, 2-20
calibration kit string and learn string, 1-29
calibration type off, 1-71
CALIFUL2, 1-39, 1-70
CALIONE2, 1-39, 1-70
CALIRAI, 1-39, 1-70
CALIRESP, 1-39, 1-70
CALIS111, 1-39, 1-70
CALIS221, 1-39, 1-70
CALITRL2, 1-39, 1-70
CALK24MM, 141, 1-70
CALK292MM, 141, 1-70
CALK292S, 141, 1-70
CALK35MC, 141, 1-70
CALK35MD, 1-41, 1-70
CALK35MM, 141, 1-70
CALK7MM, 141, 1-70
cal kit done, 1-79
CALKN50, 141, 1-70
CALKN75, 141, 1-70
CALKTRLK, 141, 1-70
CALKUSED, 141, 1-71
CALN, 1-39, 1-71
CALPOW, 1-71
cal power
 set port 1, 1-91
cal sensor table
 edit, 1-70
cal sequence
 begin, 1-70
 resume, 1-92
CALSPORT1, 1-39, 1-71
CALSPORT2, 1-39, 1-71
CALZLINE, 144, 1-71
CALZSYST[D], 144, 1-71
CBRI[D], 148, 1-71
CENT[D], 1-54, 1-59, 1-71
center, 1-71
chain for data processing, 1-26
CHAN1, 146, 1-71
CHAN2, 1-46, 1-71
CHAN3, 146, 1-71
CHAN4, 146, 1-71
channel position, 1-73
channels

- coupled, 1-73
- characters that are **valid**, 1-9
- CHOPAB, 1-41, 1-71
- citifile**
 - save format, 1-94
- CLAD, 1-44, 1-71
- CLASS11A, 1-41, 1-71
- CLASS11B, 1-41, 1-71
- CLASS11C, 141, 1-71
- CLASS22A, 1-41, 1-71
- CLASS22B, 1-41, 1-71
- CLASS22C, 141, 1-71
- class done, 1-71
- CLEABIT[D], 1-58, 1-72
- CLEA<I>, 1-56, 1-71
- CLEAL, 1-60, 1-71
- CLEARALL, 1-56, 1-71
- clear device, 1-17
- CLEAREG<I>, 1-56, 1-72
- clearing any messages waiting to be output, 2-8
- clearing syntax errors, 2-8
- clearing the input-command buffer, 2-8
- clear list**, 1-72
- clear register, 1-71
- clear sequence, 1-72, 2-8
- CLESEQ<I>, 1-57, 1-72
- CLEL, 145, 1-53, 1-72
- CLES, 1-68, 1-72
- CLS, 1-68, 1-72
- COAD, 1-57, 1-72
- COAX, 142, 1-72
- coax adapter, 1-69
- code naming conventions, 1-8
- code syntax structure, 1-9
- collect raw data, 1-98
- COLOCH1D, 148, 1-72
- COLOCH1M, 148, 1-72
- COLOCH2D, 148, 1-72
- COLOCH2M, 148, 1-72
- COLOCH3D, 148, 1-72
- COLOCH3M, 1-48, 1-72
- COLOCH4D, 148, 1-72
- COLOCH4M, 1-48, 1-72
- COLOGRAT, 1-48, 1-72
- COLOLREF, 1-72
- color
 - data channel 1, 1-89
 - data channel 2, 1-89
 - data channel 3, 1-89
 - data channel 4, 1-89
 - graticule**, 1-89
 - memory channel 1, 1-89
 - memory channel 2, 1-89
 - memory channel 3, 1-89
 - memory channel 4, 1-89
 - reference **line**, 1-89
 - text, 1-89
 - warning, 1-89
- COLOR[D]**, 148, 1-72
- COLOREF, 1-48
- colors, 1-89
- COLOTEXT, 148, 1-72
- COLOWARN, 148, 1-72
- ? command, 1-20
- command formats, 1-9
- command query, 1-20
- commands
 - HP-IB, 1-1
- command structure, 2-5
- command structure elements, 2-5
 - appendage, 2-5
 - BASIC command statement, 2-5
 - data, 2-5
 - terminators, 2-5
 - unit, 2-5
- command syntax, 1-8
- command syntax structure, 1-9
- compatible peripherals, 2-2
- complete operation, 1-19
- complete service request capabilities (**SR1**), 1-14
- compute new **cal** set, 1-83
- computer controllers, 1-1 1
- connecting the device under test, 2-12
- connecting the test system, 2-2
- CONS, 1-57, 1-72
- CONSTANTS**, 2-110
- CONT, 1-53, 1-72
- continue sequence, 1-72
- controlled sweep, 2-14
- controller
 - address, 1-69
- controller interface function, 1-1 1
- control **lines**, 1-12
- CONV1DS, 1-50, 1-73
- conventions for code naming, 1-8
- CONVOFF, 1-50, 1-73
- CONVREF, 1-73
- CONVYREF, 1-50
- CONVYTRA, 1-50, 1-73
- CONVZREF, 1-50
- CONVZTRA, 1-50, 1-73
- copy display, 1-87, 1-89, 1-90
- COPYFRFT**, 1-73
- COPYFRRT**, 1-73
- CORI<ON|OFF>**, 1-39, 1-73
- correction, 1-73
 - interpolative, 1-73
- CORR<ON|OFF>**, 1-39, 1-73

COUC<ON|OFF>, 1-53, 1-73
coupled channels, 1-73
COUP<ON|OFF>, 1-52, 1-73
CSWI, 1-73
CSWIOFF, 1-39
CSWION, 1-39
CW freq, 1-73
CWFREQ[D], 1-53, 1-54, 1-73
CW time, 1-73
CWTIME, 1-53, 1-73

D

[D], 1-39
D1DIVD2<ON|OFF>, 1-48, 1-73
D2XUPCH2, 148, 1-73
D2XUPCH3, 148, 1-73
D4XUPCH2, 148, 1-73
D4XUPCH3, 1-48, 1-73
data
 include with disk **files**, 1-76
data-array formats, 1-23
data arrays, 1-26
data bus, 1-12
data channel 1
 color, 1-89
data channel 2
 color, 1-89
data channel 3
 color, 1-89
data channel 4
 color, 1-89
data for markers, 1-21
data formats and transfers, 2-43
data levels, 1-28
data **only**
 include with disk **files**, 1-76
data-processing chain, 1-26
data rate, 1-13
data reading, 1-20
data taking, 2-12
data transfer, 1-12, 2-12, 243
 to a plotter, 2-93
 using floating-point numbers, 249
 using FORM 1, 2-54
 using FORM 4, 2-46
 using frequency-array information, 2-51
 using markers, 2-44
data-transfer character definitions, 1-21
Data Transfer **Commands**
 Fast, 1-28
data transfer for traces, 1-24
data units, 1-9
date, 1-95
DATI, 1-48, 1-73
DC1 (complete device clear), 1-14

DCONV, 1-59, 1-73
debug, 1-73
debug mode, 2-6, 2-14
DEBU<ON|OFF>, 1-50, 1-73
decrement loop counter, 1-73
DECRLOOC, 1-58, 1-73
default calibration kits, 1-70
default colors, 1-74
default settings, 1-3
DEFC, 1-48, 1-74
definitions of status bit, 1-30
DEFLPRINT, 1-46, 1-74
DEFLTCPIO, 1-62, 1-74
DEFS[D], 141, 1-74
DELA, 1-50, 1-74
delay, 1-74, 1-76
 adapter, 1-69
 set to mkr, 1-82
delete segment, 1-94
DELO, 1-54, 1-74
DELRFIXM, 1-54, 1-74
DELR<I>, 1-54
delta **limits**, 1-80
delta reference, 1-74
DEMOAMPL, 1-61, 1-74
demodulation off, 1-74
DEMOOFF, 1-61, 1-74
DEMOPHAS, 1-61, 1-75
DeskJet, 1-91
DeskJet 540, 1-91
developing program features, 2-14
device clear, 1-17
device clear (**DC1**), 1-14
device connection, 2-12
device trigger, 1-18
device types for HP-IB, 1-11
DFLT, 1-46, 1-75
directory size
 LIF, 1-75
DIRS[D], 1-57, 1-75
disabling the front panel, 1-18
DISCUNIT[D], 1-50, 1-75
DISCVOLU[D], 1-50, 1-75
disk
 load **file**, 1-81
disk drive
 address, 1-69
disk drive unit, 1-75
disk drive volume, 1-75
disk file names, 1-37
disk format, 1-77
DISM<ON|OFF>, 1-54, 1-75
DISPDATA, 1-48, 1-75
DISPDATM, 148, 1-75
DISPDDM, 148, 1-75

DISPDMM, 1-48, 1-75
display
 HP-IB addresses, 1-17
 display A/B, 1-69
 display AIR, 1-69
 display B/R, 1-70
 display data, 1-75
 display data — mem, 1-75
 display data & mem, 1-75
 display data/mem, 1-75
 display data to mem, 1-73
 display format units, 1-22
 display memory, 1-75
DISPMEMO, 148, 1-75
DIVI, 148, 1-75
does not respond to **parallel poll** (PPO), 1-14
done
 with class, 1-75
 with isolation, 1-79
 with reflection, 1-92
 with transmission, 1-99
DONE, 141, 1-75
done modify sequence, 1-75
Done **TRL/LRM**, 1-94
DONM, 1-57, 1-75
DOSEQ<I>, 1-57, 1-75
do sequence, 1-75
DOS format, 1-77
DOWN, 1-50, 1-75
down converter, 1-73
DT1 (responds to a group execute trigger),
 1-14
DTR, 1-91
DUAC<ON|OFF>, 148, 1-75
dual channels, 1-75
duplicate sequence, 1-75
DUPLSEQ<X>SEQ<Y>, 1-57, 1-75

E
E2 (tri-state drivers), 1-14
edit **cal** sensor table, 1-70
EDITDONE, 145, 1-53, 1-60, 1-76
edit **limit** table, 1-76
EDITLIML, 1-60, 1-76
EDITLIST, 1-53, 1-76
edit power loss range, 1-90
edit power loss table, 1-90
edit segment, 1-94
ELED[D], 1-57, 1-76
EMIB, 1-58, 1-76
emit beep, 1-76
end or identify, 1-10
end or identify (EOI) control **line**, 1-12
ENTO, 1-50, 1-76
entry off, 1-76

EOI, 1-10
EOI (end or identify) control **line**, 1-12
Epson-P2, 1-91
equipment
 optional, 2-2
 required, 2-2
error coefficients, 1-29, 1-63, 1-64. *See also*
 calibration coefficients
error-corrected data, 1-26
error output, 1-34
error queue, 2-57
error reporting, 1-30
ESB?, 1-68, 1-76
ESE[D], 1-68, 1-76
ESNB[D], 1-68, 1-76
ESR?, 1-68, 1-76
event-status register, 1-30, 1-32
event-status-register B, 2-83
example
 operation using **talker/listener** mode, 2-86
 Reading ASCII Disk **Files** to the Instrument
 Controller's Disk **File**, 2-96
 using the learn string, 2-66
EXTD, 1-57, 1-76
extended **listener** capabilities (LEO), 1-14
external PC, 2-36
external trigger, 1-76
EXTMDATA, 1-76
EXTMDATA<ON|OFF>, 1-56
EXTMDATO<ON|OFF>, 1-56, 1-76
EXTMFORM<ON|OFF>, 1-56, 1-76
EXTMGRAP<ON|OFF>, 1-56, 1-76
EXTMRAW<ON|OFF>, 1-56, 1-76
EXTRCHAN, 1-59, 1-76
EXTTHIGH, 1-63, 1-76
EXTTLOW, 1-63, 1-76
EXTTOFF, 1-53, 1-76
EXTTON, 1-53, 1-76
EXTTPOIN, 1-53, 1-76

F
Fast Data Transfer Commands, 1-28
features helpful in developing programming
 routines, 2-14
file names
 disk, 1-37
file titles
 recall, 1-92
firmware revision identification, 1-20
FIXE, 141, 1-76
fixed load, 1-76
fixed marker, 1-74
flat line type, 1-80
FORM1, 1-68, 1-76
FORM1 format, 1-23

FORM2, 1-68, 1-76
FORM2 format, 1-23
FORM3, 1-68, 1-76
FORM3 format, 1-23
FORM4, 1-68, 1-76
form 4 data-transfer character string, 1-21
FORM4 format, 1-23
FORM5, 1-68, 1-77
FORM5 format, 1-23
format
 disk, 1-77
format display **units**, 1-22
FORMATDOS, 1-57, 1-77
FORMATLIF, 1-57, 1-77
formats and transfers of trace-data, 2-43
formats for array-data, 1-23
formats for commands, 1-9
formatted data, 1-26
 include with disk **files**, 1-76
form feed
 plotter, 1-89
 printer, 1-91
forward calibration class, 1-77
FREQ, 1-48, 1-77
FREQOFFS<ON|OFF>, 1-59, 1-77
frequency **calculation** equation, 2-46
frequency notation, 1-77
frequency offset, 1-77
frequency offset value, 1-100
frequency-related arrays, 1-25
FRER, 1-53
full-acceptor handshake (**AH1**), 1-14
full-source handshake (**SH1**), 1-14
FULP, 1-47, 1-77
FWDI, 1-41, 1-77
FWDM, 1-41, 1-77
FWDT, 1-41, 1-77

G

GATECENT[D], 1-61, 1-77
gate center time, 1-77
gate on/off, 1-77
GATEO<ON|OFF>, 1-61, 1-77
gate shape, 1-77
 maximum, 1-77
 minimum, 1-77
 normal, 1-77
 wide, 1-77
GATESPAN[D], 1-61, 1-77
gate span time, 1-77
GATESTAR[D], 1-61, 1-77
gate start time, 1-77
GATESTOP[D], 1-61, 1-77
gate stop time, 1-77
GATSMAXI, 1-61, 1-77

GATSMINI, 1-61, 1-77
GATSNORM, 1-61, 1-77
GATSWIDE, 1-61, 1-77
general structure of syntax, 1-9
GOSUB<I>, 1-57, 1-77
gosub sequence, 1-77
GP-IB. *See* HP-IB
GPIO, 1-88
GPIO input bit, 1-88
GPIO output bits, 1-88
graticule
 color, 1-89
group execute trigger response (**DT1**), 1-14
guidelines for code naming, 1-8

H

halting all modes and functions, 1-17
handshake
 plotter, 1-89
 printer, 1-91
handshake **lines**, 1-12
helpful features for developing programs,
 2-14
HOLD, 1-53, 1-77
HP 9000 Series 300 computer, 2-2
HP-IB
 address capability, 1-13
 addresses, 1-17
 bus structure, 1-11, 1-12
 command formats, 1-9
 data rate, 1-13
 device types, 1-11
 message transfer scheme, 1-13
 meta-messages, 1-17
 multiple-controller capability, 1-13
 operation, 1-11
 operational capabilities, 1-14
 requirements, 1-13
 status indicators, 1-15
HP-IB commands, 1-1
HP-IB interconnect cables, 2-2
HP-IB **only** commands, 1-62

I

<I>, 1-39
identification
 of **analyzer**, 1-20
 of firmware revision, 1-20
IDN?, 1-20, 1-62, 1-77
IEEE-488 universal commands, 1-17
IEEE standard codes, formats, protocols
 information, 1-2
IEEE standard **digital** interface information,
 1-2
IF bandwidth, 1-78

IFBIHIGH, 1-58, 1-77
IFBILOW, 1-58, 1-77
 IFBW[D], 1-39, 1-78
 IFC (abort message), 1-17
 IFC (interface clear) control **line**, 1-12
 IFLCEQZESEQ<I>, 1-58, 1-78
 IFLCNEZESEQ<I>, 1-58, 1-78
IFLTFALSEQ<I>, 1-58, 1-78
IFLTPASSEQ<I>, 1-58, 1-78
 IMAG, 1-50, 1-78
 imaginary, 1-78
 increment loop counter, 1-78
 INCRLOOC, 1-58, 1-78
 information on programs, 2-14
INID, 1-57, 1-78
INIE, 1-57, 1-78
 initialize disk, 1-78
 INPUCALC<I>, 1-63
 INPUCALC<I>[D], 1-78
 INPUCALK[D], 1-63, 1-78
INPUATA[D], 1-63, 1-78
 INPUFORM[D], 1-63, 1-78
INPULEAS[D], 1-63, 1-78
 INPUPMCAL<I>, 1-63, 1-79
 INPURAW<I>[D], 1-63, 1-79
 input/output path, 2-10
 INSMNETA, 1-59, 1-79
 INSMTUNR, 1-59, 1-79
instrument setup, 2-11
instrument states, 2-66
 recalling, 2-66, 2-71
 saving, 2-66, 2-71
 instrument state **summary**, 1-29
 INTD, 1-57, 1-79
INTE[D], 148, 1-79
 intensity
 background, 1-69
 interface addresses, 1-17
 interface **clear** (IFC) control **line**, 1-12
 interface functions
 controller, 1-11
 listener, 1-11
 talker, 1-11
 interpolative correction, 1-73
 interrogate syntax, 1-10
 interrupts, generating, 2-59
 INTM, 1-57, 1-79
ISOD, 141, 1-79
ISOL, 141
ISOOP, 141, 1-79

K

key codes, 1-38
KEY[D], 1-62, 1-79
 key select codes, 1-39
KITD, 1-44, 1-79
 kit done, 1-79
 kits of calibration standards, 2-20
 KOR?, 1-62

L

LABEFWDM[\$], 1-44, 1-79
LABEFWDT[\$], 144, 1-79
 label **cal** kit, 1-80
 label class, 1-79
 label standard, 1-80
LABERESI[\$], 1-44, 1-79
LABERESP[\$], 1-44, 1-79
LABEREVM[\$], 1-44, 1-79
LABEREVT[\$], 144, 1-79
LABES11A[\$], 144, 1-79
LABES11B[\$], 144, 1-79
LABES11C[\$], 1-44, 1-79
LABES22A[\$], 144, 1-80
LABES22B[\$], 144, 1-80
LABES22C[\$], 144, 1-80
LABETRLI[\$], 144, 1-80
LABETRLR[\$], 144, 1-80
LABETRLT[\$], 144, 1-80
 LABK[\$], 144, 1-80
 LABS[\$], 142, 1-80
 LaserJet, 1-91
 LCD intensity, 1-79
 LCD title, 1-99
 LEO (no extended listener capabilities), 1-14
 learn string and calibration kit string, 1-29
 learn string use example program, 2-66
 LEFL, 147, 1-80
 LEFU, 147, 1-80
 levels of data, 1-28
 LIF
 directory size, 1-75
 LIF format, 1-77
LIMD[D], 1-60, 1-80
 LIMIAMPO[D], 1-60, 1-80
LIMILINE<ON|OFF>, 1-60, 1-80
 LIMIMAOF, 1-60, 1-80
LIMISTIO[D], 1-60, 1-80
LIMITEST<ON|OFF>, 1-60, 1-80
 limit line, 1-80
 limit line amplitude offset, 1-80
 limit line and data point special functions,
 2-104
 limit lines, 2-80
 setting up, 2-80
 limit line stimulus offset, 1-80

limit-line testing, 2-74
 list-frequency table, selecting a single
 segment, 2-77
 performing PASS/PAIL tests, 2-79
 using list-frequency mode, 2-74
 limit table
 edit, 1-76
 limit test, 1-80
 limit-test array used to read values example
 program, 2-51
 limit test beeper, 1-69
 limit test **fail**, 1-78
 limit test pass, 1-78
LIML[D], 1-60, 1-80
LIMM[D], 1-60, 1-80
LIMS[D], 1-60, 1-80
LIMTFL, 1-60, 1-80
LIMTSL, 1-60, 1-80
LIMTSP, 1-60, 1-80
LIMU[D], 1-60, 1-80
 linear sweep, 1-80
 line feeds, 1-10
lines for control, 1-12
lines for handshaking, 1-12
 line type
 data, 1-80
 memory, 1-80
LINFREQ, 1-53, 1-80
LINM, 1-50, 1-80
 lin mag, 1-80
LINTDATA[D], 147, 1-80
LINTMEMO[D], 147, 1-80
LISFREQ, 1-53, 1-80
 list
 clear, 1-72
listener interface function, 1-11
 listen mode (L), 1-15
 list-frequency mode, 2-74
list sweep, 1-80
 list values, 1-80
 print, 1-91
LISV, 146, 1-80
 L (**listen** mode), 1-15
LOAD<I>, 1-56, 1-81
 load no offset, 1-81
 load offset, 1-81
LOADSEQ<I>, 1-58, 1-81
LOAN, 141, 1-81
LOAO, 1-41, 1-81
 local command (GTL), 1-17
 local lockout, 2-6
 local lockout command (**LLO**), 1-18
local mode, 2-6
LOFREQ[D], 1-59, 1-81
 lo frequency, 1-81

LOGFREQ, 1-53, 1-81
LOGM, 1-50, 1-81
 log mag, 1-81
 log sweep, 1-81
LOOC[D], 1-58, 1-81
 loop counter
 decrement, 1-73
 increment, 1-78
 loop counter value, 1-81
 lower limit
 segment, 1-80
 low pass frequency, 1-95
 low pass impulse, 1-81
 low pass step, 1-81
LOWPIMPU, 1-61, 1-81
LOWPSTEP, 1-61, 1-81
LRN, 1-65

M

MANTRIG, 1-53, 1-81
MARKBUCK[D], 1-62
MARKCENT, 1-55, 1-82
MARKCONT, 1-54, 1-82
MARKCOUP, 1-54, 1-82
MARKCW, 1-58, 1-82
MARKDELA, 1-55, 1-82
MARKDISC, 1-54, 1-82
 marker bandwidth search, 1-100
 marker data, 1-21
 marker parameters
 print, 1-91
 marker positioning, 2-44
 by data point location, 244
 by frequency location, 2-44
 by trace-data value, 2-44
 marker range, 1-82
 markers
 continuous, 1-82
 discrete, 1-82
 displayed, 1-75
 markers coupled, 1-82
 marker search
 left, 1-94
 maximum, 1-94
 minimum, 1-94
 off, 1-94
 right, 1-94
 target, 1-94
 tracking, 1-99
 markers off, 1-82
 marker statistics, 1-83
 markers uncoupled, 1-82
 marker to CW frequency, 1-82
 marker to limit offset, 1-80
 marker to middle

- segment, 1-82
- marker** to stimulus
 - segment, 1-82
- marker width, 1-100
- marker zero, 1-82
- MARKFAUV[D]**, 1-54, 1-82
- MARKFSTI[D]**, 1-54, 1-82
- MARKFVAL[D]**, 1-54, 1-82
- MARK<I>[D]**, 1-54, 1-82
- MARKMAXI**, 1-55
- MARKMIDD**, 1-60, 1-82
- MARKMINI**, 1-55, 1-82
- MARKOFF**, 1-54, 1-82
- MARKREF**, 1-55, 1-57, 1-82
- MARKSPAN**, 1-55, 1-82
- MARKSTAR**, 1-55, 1-82
- MARKSTIM**, 1-60, 1-82
- MARKSTOP**, 1-55, 1-82
- MARKUNCO**, 1-54, 1-82
- MARKZERO**, 1-54, 1-82
- MAXF[D]**, 142, 1-82
- MEASA**, 1-50, 1-83
- MEASB**, 1-50, 1-83
- MEASR**, 1-50, 1-83
- MEASTAT<ON|OFF>**, 1-55, 1-83
- measurement calibration, 1-34
- measurement data post-processing, 2-12
- measurement data taking, 2-12
- measurement parameters
 - required order, 2-15
 - setting, 2-15
 - verifying, 2-18
- measurement process, 2-1 1
- measurement restart, 1-93
- measurement setup, 2-15
- measurement specifications, 2-48
 - group delay, 248
 - magnitude, 248
 - phase, 248
- memory channel 1
 - color, 1-89
- memory channel 2
 - color, 1-89
- memory channel 3
 - color, 1-89
- memory channel 4
 - color, 1-89
- memory requirements, 2-2
- MENU**, 1-83
- MENUAVG**, 1-68, 1-83
- MENUCAL**, 1-68, 1-83
- MENUCOPY**, 1-68, 1-83
- MENUDISP**, 1-68, 1-83
- MENUFORM**, 1-68, 1-83
- MENUMARK**, 1-68, 1-83

- MENUMEAS**, 1-68, 1-83
- MENUMRKF**, 1-68, 1-83
- MENU<ON|OFF>**, 1-68
- MENURECA**, 1-68, 1-83
- MENUSAVE**, 1-68, 1-83
- MENUSCAL**, 1-68, 1-83
- MENUSEQU**, 1-68, 1-83
- MENUSTIM**, 1-68, 1-83
- MENUSYST**, 1-68, 1-83
- message transfer scheme, 1-13
- meta-messages, 1-17
- methods of **HP-IB** operation, 1-11
- middle **value**
 - segment, 1-80
- MINF[D]**, 142, 1-83
- MINMAX<ON|OFF>**, 1-67, 1-83, 2-105
- min/max** recording, 1-83
- MINU**, 148, 1-83
- Mixer measurements, 2-100
- modes
 - analyzer bus, 1-16
 - debug, 2-14
 - pass-control, 1-16
 - system-controller, 1-15
 - talker/listener, 1-16
- modes for bus device, 1-15
- MODI1**, 141, 1-83
- modify **cal** kit, 1-83
- modify colors, 1-72
- modify sequence, 1-83
- MODS**, 1-39, 1-83
- multiple-controller capability, 1-13

N

- naming conventions, 1-8
- network **analyzer** mode, 1-79
- NEWSE<I>**, 1-57, 1-83
- new sequence, 1-83
- NEXP**, 146, 1-83
- next page, 1-83
- no extended talker capabilities (TEO), 1-14
- NOOP**, 1-63, 1-83
- number of **HP-IB** devices **allowed**, 1-11
- number of listeners **allowed**, 1-11
- number of readings, 1-83
- NUMG[D]**, 1-53, 1-83
- NUMR[D]**, 145, 1-83

0

- offloading error correction, 2-36
- OFLD**, 1-41, 1-84
- OFLS**, 1-41, 1-84
- OFSD[D]**, 142, 1-84
- OFSL[D]**, 142, 1-84
- OFSZ[D]**, 142, 1-84

OMII, 1-41, 1-84
 OPC, 1-62, 1-84
 OPC-compatible commands, 1-19
 open capacitance values, 1-70
 OPEP, 1-46, 1-84
 operating parameters, 1-84
 operational capabilities for HP-IB, 1-14
 operation complete, 1-19
 operation complete commands, 2-8
 operation of analyzer, 1-19
 operation of HP-IB, 1-11
 operation using taker/listener mode example
 program, 2-86
ORIENT<VERT|ORIENT>, 1-84
 OUTPACTI, 1-64
 OUTPAMAX, 1-66, 1-84, 2-105
 OUTPAMIN, 1-66, 1-84, 2-105
 OUTPAPER, 1-65
 OUTPCALC, 1-64
 OUTPCAL<I>, 1-84
 OUTPCALK, 1-64, 1-85
 OUTPCHAN, 1-64, 1-85
 OUTPDAPT, 1-66, 2-105
 OUTPDATA, 1-64, 1-85
 OUTPDATF, 1-64, 1-85
 OUTPDATP, 1-85
 OUTPDATR, 1-66, 1-85, 2-105
 OUTPERRO, 1-64, 1-85
 OUTPFAIP, 1-67, 1-85, 2-105
 OUTPFORF, 1-64, 1-85
 OUTPFORM, 1-64, 1-85
 OUTPICAL<I>, 1-64, 1-86
 OUTPIDEN, 1-62, 1-86
 OUTPIPMCAL<I>, 1-64
 OUTPIPMCL<I>, 1-86
OUTPKEY, 1-64, 1-86
 OUTPLEAS, 1-65, 1-86
OUTPLIM1, 1-67, 1-86, 2-105
OUTPLIM2, 1-67, 1-86, 2-105
OUTPLIM3, 1-67, 1-86
OUTPLIM4, 1-67, 1-86
 OUTPLIMF, 1-65, 1-87
 OUTPLIML, 1-65, 1-87
 OUTPLIMM, 1-65, 1-87
 OUTPMARK, 1-65, 1-87
 OUTPMEMF, 1-65, 1-87
 OUTPMEMO, 1-65, 1-87
 OUTPMSTA, 1-65, 1-87
 OUTPMWID, 1-65, 1-87
 OUTPMWIL, 1-65, 1-87
 OUTPOPTS, 1-64, 1-87
 OUTPPLOT, 1-65, 1-87
 OUTPPMCAL<I>, 1-64, 1-87
 OUTPPRE, 2-36
 OUTPPRE<I>, 1-66, 1-87

OUTPPRIN, 1-66, 1-87
 OUTPPRNALL, 1-66, 1-88
 OUTPRAF<I>, 1-66
OUTPRAW<I>, 1-66, 1-88
 OUTPSEGAF, 1-67, 1-88, 2-105
 OUTPSEGAM, 1-66, 1-88, 2-105
 OUTPSEGF, 1-67, 1-88, 2-105
 OUTPSEGM, 1-88
 OUTPSEGM[D], 1-66, 2-105
 OUTPSEQ<I>, 1-65, 1-88
OUTPSERN, 1-64, 1-88, 2-105
OUTPSTAT, 1-66, 1-68, 1-88
OUTPTITL, 1-66, 1-88
 output
 plot string, 1-87
 output chl status, 1-86
 output **ch2** status, 1-86
 output **ch3** status, 1-86
 output **ch4** status, 1-86
 output data by point, 1-85
 output data by range, 1-85
 output-data command, 1-20
 Output Data Per Point, 2-117
 Output Data Per Range of Points, 2-118
 Output Limit **Pass/Fail** by Channel, 2-119
 output **limit** test **min/max**, 1-88
 Output Limit **Test Pass/Fail** Status Per Limit
 Segment, 2-111
 output **limit** test status, 1-88
 output max values, 1-84
 Output Minimum and Maximum Point For
 All Segments, 2-115
 Output **Minimum** and Maximum Point Per
 Limit Segment, 2-114
 output min values, 1-84
 output number of failures, 1-85
 output of errors, 1-34
 Output **Pass/Fail** Status for **All** Segments,
 2-112
 output pre-raw data, 1-87
 output queue, 1-20
 output segment number, 1-88
 output syntax, 1-20
 outputting trace-related data, 1-2 1

P

PaintJet, 1-91
 PARAIN[D], 1-58, 1-88
PARAL<GPIO|CPY>, 1-50, 1-88
parallel poll configure, 1-18
 parallel **poll** non response (PPO), 1-14
parallel port configure, 1-88
PARAOUT[D], 1-58, 1-88
 pass control, 1-100
 pass control capabilities (C10), 1-14

pass-control mode, 1-16
 pass control mode, 1-18
 PASS/FAIL tests, 2-83
PAUS, 1-58, 1-88
 pause, 1-88
 pause to select sequence, 1-91
PCB[D], 1-50, 1-88
 PC-graphics applications example program,
 2-95
PCOLDATA1<color>, 1-47, 1-89
PCOLDATA2<color>, 1-47, 1-89
PCOLDATA3<color>, 1-47, 1-89
PCOLDATA4<color>, 1-47, 1-89
PCOLGRAT<color>, 147, 1-89
PCOLMEMO1<color>, 147, 1-89
PCOLMEMO2<color>, 147, 1-89
PCOLMEMO3<color>, 147, 1-89
PCOLMEMO4<color>, 147, 1-89
PCOLREFL<color>, 147, 1-89
PCOLTEXT<color>, 147, 1-89
PCOLWARN1<color>, 147
PCOLWARN<color>, 1-89
PDATA<ON|OFF>, 147, 1-89
PENNDATA[D], 147, 1-89
PENNGRAT[D], 147, 1-89
PENNMARKE[D], 147, 1-89
PENNMEMO[D], 1-47, 1-89
PENNTEXT[D], 147, 1-89
 pen number
 data, 1-89
 graticule, 1-89
 markers, 1-89
 memory, 1-89
 text, 1-89
 peripheral
 address, 1-69
 peripheral addresses, 1-17
PGRAT<ON|OFF>, 147, 1-89
PHAO[D], 1-57, 1-89
PHAS, 1-50, 1-89
 phase, 1-89
 phase and amplitude tracking, 2-100
 phase offset, 1-89
 phase tracking, 2-100
PLOS, 1-89
PLOSFAST, 147
PLOSSLOW, 147
PLOT, 146, 1-89
 plot data, 1-89
 plot **file** and PC-graphics example program,
 2-95
 plot **graticule**, 1-89
 plot markers, 1-90
 plot memory, 1-89
 plot quadrant, 1-80, 1-93
 plot scale, 1-94
 plot softkeys, 1-91
 plot speed, 1-89
 plot string
 output, 1-87
 plotter
 address, 1-69
 auto feed, 1-89
 baud rate, 1-89
 form feed, 1-89
 handshake, 1-89
 plotter default setup, 1-75
 plotter port
 disk, 1-89
 HP-IB, 1-89
 parallel, 1-89
 serial, 1-89
 plotter type, 1-89
 plot text, 1-91
 plotting
 to a file, 2-93
 plotting, remote, 2-86, 2-88
PLTHNDSHK<XON|DTR>, 1-50, 1-89
PLTPRTDISK, 1-50, 1-89
PLTPRTHPIB, 1-50, 1-89
PLTPRTPARA, 1-50, 1-89
PLTPRTSERI, 1-50, 1-89
PLTTRAUTF<ON|OFF>, 146, 1-89
PLTTRBAUD[D], 1-50, 1-89
PLTTRFORF, 146, 1-89
PLTTYHPGL, 1-50, 1-89
PLTTYPLTR, 1-50, 1-89
PMEM<ON|OFF>, 147, 1-89
PMKR<ON|OFF>, 147, 1-90
PMTRTIT, 1-58, 1-90
POIN[D], 1-53, 1-54, 1-90
 points
 specify, 1-90
POLA, 1-50, 1-90
polar, 1-90
 polar markers, 1-90
POLMLIN, 1-54, 1-90
POLMLOG, 1-54, 1-90
POLMRI, 1-54, 1-90
PORE<ON|OFF>, 1-39, 1-90
PORT1[D], 1-39, 1-90
PORT2[D], 1-39, 1-90
PORTA[D], 1-39, 1-90
PORTB[D], 1-39, 1-90
 port extensions, 1-90
PORTP<CPLD|UNCPLD>, 1-52, 1-90
 port power coupling, 1-90
PORTR[D], 1-90
PORTT[D], 1-90
 post-processing the measurement data, 2-12

POWE[D], 1-52, 1-90
 power level, 1-90
 power loss range
 edit, 1-90
 power loss table, 1-91
 edit, 1-90
 power meter
 address, 1-69
 power meter **cal** factor, 1-70
 power meter calibration, 1-91, 2-62
 power meter into title string, 1-90
 power meter type, 1-90
 power ranges, 1-90
 power sweep, 1-90
 power trip, 1-90
 POWLFREQ[D], 145, 1-90
 POWLLIST, 1-45, 1-90
 POWLLOSS[D], 145, 1-90
 POWM, 1-90
 POWM<ON|OFF>, 1-50
 POWR, 1-90
 POWROO, 1-52
 POWR01, 1-52
 POWR02, 1-52
 POWR03, 1-52
 POWR04, 1-52
 POWR05, 1-52
 POWR06, 1-52
 POWR07, 1-52
 POWR08, 1-52
 POWR09, 1-52
 POWR10, 1-52
 POWR11, 1-52
 POWS, 1-53, 1-90
 POWT<ON|OFF>, 1-52, 1-90
 PPO (does not respond to **parallel poll**), 1-14
 PRAN, 1-90
 PRAN01, 1-52
 PRAN011, 1-52
 PRAN02, 1-52
 PRAN03, 1-52
 PRAN04, 1-52
 PRAN05, 1-52
 PRAN06, 1-52
 PRAN07, 1-52
 PRAN08, 1-52
 PRAN09, 1-52
 PRAN10, 1-52
 PRAN12, 1-52
 PREP, 1-46, 1-90
 preparing for remote operation, 2-8
 pre-raw data, 2-36
 pre-raw data, output, 1-87
 PRES, 1-90
 preset state, 1-3
 presetting the instrument, 2-8
 PRIC, 1-46, 1-90
 PRINALL, 1-46, 1-90
 PRINSEQ<I>, 1-57, 1-90
 PRINTALL, 146, 1-91
 print color, 1-90
 printer
 address, 1-69
 auto feed, 1-91
 baud rate, 1-91
 form feed, 1-91
 handshake, 1-91
 printer default setup, 1-74
 printer port
 HP-ID, 1-91
 parallel, 1-91
 serial, 1-91
 printing
 using the **serial** port, 2-91
 printing, remote, 2-86, 2-88
 print monochrome, 1-91
 print sequence, 1-90
 print softkeys, 1-91
 PRIS, 146, 1-91
 PRNHNSHK<XON|DTR>, 1-50, 1-91
 PRNPRTHPIB, 1-50, 1-91
 PRNPRTPARA, 1-50, 1-91
 PRNPRTSERI, 1-50, 1-91
 PRNTRAUTF<ON|OFF>, 146, 1-91
 PRNTRBAUD[D], 1-50, 1-91
 PRNTRFORF, 146, 1-91
 PRNTYP540, 1-50, 1-91
 PRNTYPDJ, 1-50, 1-91
 PRNTYPEP, 1-50, 1-91
 PRNTYPLJ, 1-50, 1-91
 PRNTYPPJ, 1-50, 1-91
 PRNTYPTJ, 1-50, 1-91
 processing after taking measurement data,
 2-12
 processing data chain, 1-26
 process of measuring, 2-11
 program debugging, 2-14
 program development features, 2-14
 program example
 operation using talker/listener mode, 2-86
 using the learn string, 2-66
 program information, 2-14
 PSOFT<ON|OFF>, 1-62, 1-91
 PTEXT<ON|OFF>, 147, 1-91
 PTOS, 1-57, 1-91
 purge **file**, 1-91
 PURG<I>, 1-56, 1-91
 PWMCEACS[D], 145, 1-91
 PWMCOFF[D], 1-45, 1-91
 PWMCONES[D], 145, 1-91

PWRLOSS<ON|OFF>, 1-45, 1-91
PWRMCAL, 1-45, 1-91
PWRR<PAUTO/PMAN>, 1-52, 1-92

Q

Q<I>, 1-57, 1-92
quasi 2-port cal, 1-73
query command, 1-20
querying commands, 2-6
queue for output, 1-20

R

RAID, 141, 1-92
RAISOL, 1-41, 1-92
RAIRESP, 141, 1-92
raw data
 creating a calibration, 2-29
 include with disk files, 1-76
raw measured data, 1-26
raw offsets, 2-36
RAWOFFS<ON|OFF>, 1-92
READDATE, 1-67
reading analyzer data, 1-20
READTIME, 1-67
REAL, 1-50, 1-92
RECA<I>, 1-56, 1-92
recall cal set
 port 1, 1-71
 port 2, 1-71
recall colors, 1-92
recall register, 1-92
recall sequence, 1-81
RECAREG<I>, 1-56, 1-92
receiver calibration, 1-92
RECO, 148, 1-92
recommended disk drives, 2-2
recommended plotters, 2-2
recommended printers, 2-2
REFD, 141, 1-92
reference line
 color, 1-89
reference line value, 1-92
reference position, 1-92
 set to mkr, 1-82
REFL, 141, 1-92
reflection, 1-71
REFOP, 1-41, 1-92
REFP[D], 1-57, 1-92
REFT, 1-56, 1-92
REFV[D], 1-57, 1-92
REIC[D], 1-39, 1-92
remote enable (REN) control line, 1-12
remote/local capability (RL1), 1-14
remote mode, 1-18, 2-6
remote operation (R), 1-15

REN (remote enable) control line, 1-12
report generation, 2-86
reporting of errors, 1-30
reporting on status, 1-30
reporting status, 2-56
RESC, 1-39, 1-92
RESD, 146, 1-93
reset color, 1-93
RESPDONE, 1-41, 1-93
response cal done, 1-93
REST, 1-52, 1-93
restart averaging, 1-69
restore display, 1-93
resume cal sequence, 1-92
RETP<ON|OFF>, 1-59, 1-93
retrace power, 1-93
REVI, 1-93
REVM, 141, 1-93
REVO, 141
REVT, 141, 1-93
RFGTLO, 1-59, 1-93
RF < LO, 1-93
RF > LO, 1-93
RFLP, 1-50, 1-93
RFLTLO, 1-59, 1-93
RIGL, 1-93
RIGU, 147, 1-93
RL1 (complete remote/local capability), 1-14
routing debugging, 2-14
R (remote operation), 1-15
Rsc0, 1-48, 1-93
RST, 1-93
rules for code naming, 1-8

S

S11, 1-50, 1-93
S12, 1-50, 1-93
S21, 1-50, 1-93
S22, 1-50, 1-93
SADD, 145, 1-53, 1-60, 1-93
sampler, attenuator offsets, 1-92
sampler correction, 2-36
sampler offsets, 2-36
SAV1, 141, 1-93
SAV2, 1-41, 1-93
SAVC, 1-63, 1-93
save cal kit, 1-94
save colors, 1-98
save format, 1-94
SAVE<I>, 1-56, 1-93
SAVEREG<I>, 1-56, 1-94
save register, 1-93
save sequence, 1-98
SAVEUSEK, 144, 1-94
SAVT, 141, 1-94

SAVUASCI, 1-56, 1-94
 SAVUBINA, 1-56, 1-94
 SCAL[D], 1-57, 1-94
 scale
 auto, 1-69
 SCAP<FULL|GRAT>, 1-47, 1-94
 SDEL, 1-45, 1-53, 1-60, 1-94
 SDON, 1-45, 1-54, 1-60, 1-94
 SEAL, 1-55, 1-94
 SEAMAX, 1-55, 1-94
 SEAMIN, 1-55, 1-94
 SEAOFF, 1-55, 1-94
 SEAR, 1-55, 1-94
 SEATARG[D], 1-55, 1-94
 SEDI[D], 145, 1-53, 1-60, 1-94
 segment
 add, 1-93
 delete, 1-94
 edit, 1-94
 segment edit done, 1-76
 segment select, 1-96
 select first **point**[D], 1-94
 select last **point**[D], 1-94
 select point **number**[D], 1-95
 select segment **number**[D], 1-95
 select sequence, 1-92, 1-95
 select standard, 1-97
 SELL[D], 1-62
 SELMAXPT[D], 1-67, 1-94, 2-105
 SELMINPT[D], 1-67, 1-94, 2-105
 SELPT[D], 1-67, 1-95, 2-105
 SELSEG[D], 1-67, 1-95, 2-105
 sensor input selection, 1-100
 SEQ<I>, 1-57, 1-95
 sequence wait, 1-95
 SEQWAIT[D], 1-58, 1-95
 serial poll, 1-18
 service request, 2-59
 service request asserted by the analyzer (**S**),
 1-15
 service request (SRQ) control line, 1-12
 set bandwidth, 1-78
 SETBIT[D], 1-58, 1-95
 SETDATE[\$], 1-59, 1-95
 SETF, 1-61, 1-95
 set reference
 reflect, 1-95
 thru, 1-95
 SETRREFL, 1-44, 1-95
 SETRTHRU, 1-44, 1-95
 SETTIME[\$], 1-59, 1-95
 setting addresses, 2-2
 setting HP-IB addresses, 1-17
 setting the control mode, 2-2
 setting up the instrument, 2-11
 setting up the system, 2-2
 SETZ[D], 1-39, 1-95
 SH1 (full-source handshake), 1-14
 SHOM, 1-58, 1-95
 show menus, 1-95
 simmcad, 2-29
 SING, 1-53, 1-95
 single bus concept, 1-15
 single point type, 1-80
 SLID, 141, 1-95
 sliding load, 1-95
 done, 1-95
 set, 1-95
 SLIL, 141, 1-95
 SLIS, 1-41, 1-95
 sloping line type, 1-80
 SMIC, 1-50, 1-95
 SMIMGB, 1-55, 1-95
 SMIMLIN, 1-55, 1-95
 SMIMLOG, 1-55, 1-95
 SMIMRI, 1-55, 1-95
 SMIMRX, 1-55, 1-95
 Smith chart, 1-95
 Smith markers, 1-95
 SMOOAPER[D], 1-39, 1-95
 SMOOO<ON|OFF>, 1-39, 1-95
 smoothing, 1-95
 smoothing aperture, 1-95
 SOFR, 1-62, 1-95
 SOFT[I], 1-68, 1-95
 SOUP<ON|OFF>, 1-52, 1-96
 source power on/off, 1-96
 SPAN[D], 1-54, 1-59, 1-96
 S-parameters, 1-93
 SPECFWDM[I], 142, 1-96
 SPECFWDT[I], 142, 1-96
 specify class, 1-96
 specify gate menu, 1-96
 specify points, 1-90
 SPECRESI[I], 142, 1-96
 SPECRESP[I], 142, 1-96
 SPECREVM[I], 1-42, 1-96
 SPECREVT[I], 142, 1-96
 SPECS11A[I], 142, 1-96
 SPECS11B[I], 142, 1-96
 SPECS11C[I], 142, 1-96
 SPECS22A[I], 142, 1-96
 SPECS22B[I], 142, 1-96
 SPECS22C[I], 142, 1-96
 SPECTRLL, 142, 1-96
 SPECTRLR, 142, 1-96
 SPECTRLT, 142, 1-96
 SPEG, 1-61, 1-96
 SPLD<ON|OFF>, 148, 1-96
 SPLID1, 148, 1-96

SPLID2, 1-48, 1-96
SPLID4, 1-48, 1-96
 split display, 1-96
 spur avoidance, 2-36
SR1 (complete service request capabilities), 1-14
SRE[D], 1-68
SRQ (service request) control line, 1- 12
SSEG[D], 1-53, 1-54, 1-96
S (service request asserted by the analyzer), 1-15
STANA, 141, 1-97
STANB, 141, 1-97
STANC, 141, 1-97
STAND, 141, 1-97
 standard defined, 1-97
 standard definition, 1-74
 standard labelling, 1-80
 standard offsets, 1-84
 standard type, 1-97
STANE, 141, 1-97
STANF, 141, 1-97
STANG, 141, 1-97
STAR[D], 1-54, 1-59, 1-97
 statistics
 marker, 1-83
 status bit definitions, 1-30
 status byte, 1-30, 1-32, 2-56
STATUS CONSTANTS, 2-110
 status indicators, 1-15
 status reporting, 1-30, 2-56
STB?, 1-66, 1-96
STDD, 142, 1-97
STDTARBI, 141, 1-97
STDTDELA, 141, 1-97
STDTLOAD, 141, 1-97
STDTOPEN, 141, 1-97
STDTSHOR, 141, 1-97
 step 1 of a measurement, 2-11
 step 2 of a measurement, 2-11
 step 3 of a measurement, 2-12
 step 4 of a measurement, 2-12
 step 5 of a measurement, 2-12
 step 6 of a measurement, 2-12
 step down, 1-75
STEPSPW<ON|OFF>, 1-53, 1-59, 1-97
 step up, 1-100
 stimulus value
 segment, 1-80
STOP[D], 1-54, 1-59, 1-97
 storage
 disk, 1-76, 1-79
 internal memory, 1-79
 store to disk, 1-97
STOR<I>, 1-56, 1-97
STORSEQ<I>, 1-58, 1-98
STPSIZE[D], 1-54, 1-98
 string for calibration kit, 1-29
 structure of command syntax, 1-9
 structure of HP-IB bus, 1-12
 structure of status reporting, 1-30
SVCO, 1-48, 1-98
SWEA, 1-52, 1-98
 sweep user-controlled, 2-14
 sweet start, 1-98
SWET[D], 1-52, 1-98
SWPSTART, 1-63, 1-98, 2-36
SWR, 1-50, 1-98
 synchronization, 2-56
 syntax for commands, 1-8
 syntax for output, 1-20
 syntax structure, 1-9
 syntax types, 1-10
 system controller capabilities (C1,C2,C3), 1-14
 system-controller mode, 1-15, 1-16
 system setups, 2-66
 reading calibration data, 2-68

T
T6 (basic talker), 1-14
TAKCS, 145, 1-98
Take4 mode, 1-87, 1-92, 1-98, 2-36
TAKE4ON, 2-36
TAKE4<ON|OFF>, 1-63, 1-98
 take cal sweep, 1-98
 take-control command, 1-18
 taking the measurement data, 2-12
TAKRS, 1-39, 1-98
talker interface function, 1-11
talker/listener, 1-98
talker/listener mode, 1-16
 talker/listener mode operation example
 program, 2-86
TALKLIST, 1-50, 1-98
talk mode (T), 1-15
 TEO (no extended talker capabilities), 1-14
TERI[D], 141
 terminators, 1-10
TESS?, 1-98
 test port return cables, 2-2
 test port selection, 1-100
 test set switching, 1-73
 test setup calibration, 2-11
 text
 color, 1-89
ThinkJet, 1-91
TIMDTRAN<ON|OFF>, 1-61, 1-98
 time, 1-95
 time domain bandpass, 1-69

time domain gate, 1-77
 time specify, 1-98
TIMESTAM<ON|OFF>, 1-59, 1-98
 time stamp, 1-98
TINT[D], 1-48, 1-98
TITF0<I>[\$], 1-56, 1-98
TITF<I>[\$], 1-56, 1-98
TITL[\$], 1-48, 1-99
 title
 LCD, 1-99
 title disk **file**, 1-98
 title plot **file**, 1-99
 title register, 1-99
 title sequence, 1-99
 title string to trace memory, 1-99
 title to peripheral, 1-99
 title to printer, 1-99
TITP[\$], 1-46, 1-56, 1-99
TITREG<I>[\$], 1-56, 1-99
TITR<I>[\$], 1-56, 1-99
TITSEQ<I>[\$], 1-57, 1-99
TITSQ, 1-57
TITMEM, 1-58, 1-99
TITPERI, 1-58, 1-99
TITPMTR, 1-58
TITPRIN, 1-58, 1-99
 trace-data formats and transfers, 243
 trace-data transfers, 1-24
 trace memory, 1-26
 trace-related data, 1-2 1
TRACK<ON|OFF>, 1-55, 1-99
TRAD, 141, 1-99
TRAN, 141, 1-99
 transfer of data, 1-12
 transferring the measurement data, 2-12
 transfers and formats of trace-data, 243
 transfers of trace-data, 1-24
 transform, 1-98
TRAOP, 141, 1-99
TRAP, 1-50, 1-99
TRIG, 1-53, 1-99
 trigger
 continuous, 1-72
 external, 1-76
 hold, 1-77
 number of groups, 1-83
 single, 1-95
 trigger device, 1-18
 tri-state drivers (**E2**), 1-14
TRLL1, 141, 1-99
TRLL2, 141, 1-99
TRLR1, 141, 1-99
TRLR2, 141, 1-99
TRLT, 141, 1-99
 troubleshooting, 24, 2-6

TSSWI<ON/OFF>, 1-39, 1-99
TST?, 1-63, 1-100
TSTIOFWD, 1-58
TSTIOFWD[D], 1-100
TSTIOREV, 1-58
TSTIOREV[D], 1-100
TSTP<P1|P2>, 1-50, 1-100
 T (talk mode), 1-15
TTLHPULS, 1-58, 1-100
TTLLPULS, 1-58, 1-100
'TLOH, 1-58, 1-100
TTLOL, 1-58, 1-100
TTL out high, 1-100
TTL out low, 1-100
 tuned receiver mode, 1-79
 types of syntax, 1-10

U

UCONV, 1-59, 1-100
 units, 1-9
units as a function of display format, 1-22
 universal commands, 1-17
UP, 1-50, 1-100
 up converter, 1-100
 upper limit
 segment, 1-80
USEPASC, 1-50, 1-100
user-controllable sweep, 2-14
 user-defined **cal** kits, 1-70
 user-defined kit
 save, 1-94
 user graphics
 include with disk **files**, 1-76
USES<ENSA|ENSB>, 145, 1-100
 use sensor A, 1-100
 use sensor B, 1-100

V

valid characters, 1-9
 velocity factor, 1-100
VELOFACT[D], 1-39, 1-100
 verifying **HP-IB** operation, 2-2
VIEM<ON|OFF>, 1-59, 1-100
 view measurement, 1-100
VOFF[D], 1-59, 1-100

W

WAIT, 1-63, 1-100
 waiting-for-group-execute-trigger, 1-18
 waiting-for-reverse-get bit, 1-18
warning
 color, 1-89
 warning beeper, 1-69
WAVD, 1-57, 1-100
WAVE, 142, 1-100

waveguide adapter, 1-69
WIDT<ON|OFF>, 1-55, 1-100
WIDV[D], 1-55, 1-100
WINDMAXI, 1-61, 1-100
WINDMINI, 1-61, 1-100
WINDNORM, 1-61, 1-100
window
 maximum, 1-100
 minimum, 1-100
 normal, 1-100
 shape, 1-101

 value, 1-100
WINDOW[D], 1-61, 1-100
WINDUSEM<ON|OFF>, 1-61, 1-101
WRSK<I>[&], 1-68, 1-101

X

Xon, 1-91

Z

zo, 1-95